

FURUNO

OPERATOR'S MANUAL

COLOR INSTRUMENT

Model

FI-70

ECF

(Elemental Chlorine Free)

The paper used in this manual
is elemental chlorine free.

FURUNO ELECTRIC CO., LTD.

9-52 Ashihara-cho,
Nishinomiya, 662-8580, JAPAN

• FURUNO Authorized Distributor/Dealer

All rights reserved. Printed in Japan

Pub. No. OME-72810-E1

(REFU) FI-70

A : JAN. 2015

E1 : MAR. 06, 2018



0 0 0 1 9 0 0 6 2 1 4

IMPORTANT NOTICES

General

- This manual has been authored with simplified grammar, to meet the needs of international users.
- The operator of this equipment must read and follow the descriptions in this manual. Wrong operation or maintenance can cancel the warranty or cause injury.
- Do not copy any part of this manual without written permission from FURUNO.
- If this manual is lost or worn, contact your dealer about replacement.
- The contents of this manual and equipment specifications can change without notice.
- The example screens (or illustrations) shown in this manual can be different from the screens you see on your display. The screens you see depend on your system configuration and equipment settings.
- Save this manual for future reference.
- Any modification of the equipment (including software) by persons not authorized by FURUNO will cancel the warranty.
- The following concern acts as our importer in Europe, as defined in DECISION No 768/2008/EC.
 - Name: FURUNO EUROPE B.V.
 - Address: Ridderhaven 19B, 2984 BT Ridderkerk, The Netherlands
- All brand and product names are trademarks, registered trademarks or service marks of their respective holders.

How to discard this product

Discard this product according to local regulations for the disposal of industrial waste. For disposal in the USA, see the homepage of the Electronics Industries Alliance (<http://www.eiae.org/>) for the correct method of disposal.

How to discard a used battery

Some FURUNO products have a battery(ies). To see if your product has a battery, see the chapter on Maintenance. Follow the instructions below if a battery is used. Tape the + and - terminals of battery before disposal to prevent fire, heat generation caused by short circuit.

In the European Union

The crossed-out trash can symbol indicates that all types of batteries must not be discarded in standard trash, or at a trash site. Take the used batteries to a battery collection site according to your national legislation and the Batteries Directive 2006/66/EU.

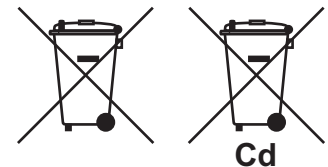

In the USA

The Mobius loop symbol (three chasing arrows) indicates that Ni-Cd and lead-acid rechargeable batteries must be recycled. Take the used batteries to a battery collection site according to local laws.

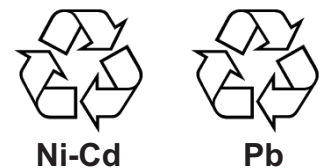

In the other countries

There are no international standards for the battery recycle symbol. The number of symbols can increase when the other countries make their own recycle symbols in the future.



SAFETY INSTRUCTIONS

The operator and installer must read the applicable safety instructions before attempting to operate or install the equipment.



WARNING

Indicates a potentially hazardous situation which, if not avoided, could result in death or serious injury.



CAUTION

Indicates a potentially hazardous situation which, if not avoided, can result in minor or moderate injury.



Warning, Caution



Prohibitive Action



Mandatory Action

Safety instructions for the operator

Safety instructions for the installer

WARNING



Do not open the equipment.

Only qualified personnel should work inside the equipment. There are no serviceable or replaceable parts inside the equipment.



Do not disassemble or modify the equipment.

Fire or electrical shock can result if the equipment is modified.



Do not operate the equipment with wet hands.

Electrical shock can result.



Make sure no rain or water splash leaks into the equipment.

Fire or electrical shock can result if water leaks into the equipment.



Immediately turn off the power at the switchboard if water leaks into the equipment.

Continued use of the equipment can cause fire or electrical shock.



CAUTION



Do not use high-pressure cleaners to clean this equipment.

This equipment has the waterproof rating outlined in the specifications, at the back of this manual. However, the use of high-pressure cleaning equipment can cause water ingress, resulting in damage to, or failure of, the equipment.

WARNING



Turn off the power at the switchboard before beginning the installation.

Turn off the power to prevent electrical shock.



Make sure the installation site is not subject to water spray.

Fire or electrical shock can result if water leaks into the equipment.



CAUTION



Observe the following compass safe distances to prevent interference to a magnetic compass:

	Standard Compass	Steering Compass
FI-70	0.30 m	0.30 m
IF-NMEAFI	0.30 m	0.30 m

About the TFT LCD

The TFT LCD is constructed using the latest LCD techniques, and displays 99.99% of its pixels. The remaining 0.01% of the pixels may drop out or blink, however this is not an indication of malfunction.

TABLE OF CONTENTS

- FOREWORD..... v**
- SYSTEM CONFIGURATION vi**
- EQUIPMENT LISTS..... vii**

- 1. OPERATION AND CONTROLS OVERVIEW..... 1-1**
 - 1.1 Controls 1-1
 - 1.2 How to Turn the Power On/Off 1-1
 - 1.3 How to Adjust the Screen Brilliance 1-2
 - 1.4 Menu Overview..... 1-2
 - 1.5 How to Turn Key Beeps On/Off..... 1-3
 - 1.6 How to Adjust the Panel Dimmer (Control Key Panel Backlights)..... 1-4
 - 1.7 Screen Categories and Page Setup 1-4
 - 1.7.1 How to change the displayed page 1-5
 - 1.7.2 How to set up pages..... 1-6

- 2. DISPLAY CATEGORIES AND CATEGORY SPECIFIC MENUS 2-1**
 - 2.1 Compass Category 2-1
 - 2.2 Speed Category..... 2-2
 - 2.3 Engine Category 2-3
 - 2.4 Graph Category 2-4
 - 2.5 Highway Category 2-5
 - 2.6 Rudder Category 2-5
 - 2.7 Timer Category 2-6
 - 2.7.1 How to use the timers..... 2-6
 - 2.7.2 How to adjust the timers 2-7
 - 2.8 Wind Category 2-8
 - 2.9 AIS Category 2-9
 - 2.9.1 How to display AIS target details..... 2-10
 - 2.9.2 How to change AIS orientation 2-10
 - 2.10 Custom Box Category 2-11
 - 2.10.1 How to customize the data boxes 2-12
 - 2.10.2 How to resize data boxes 2-13
 - 2.10.3 Data which may be displayed in custom boxes..... 2-14

- 3. ALARMS 3-1**
 - 3.1 How to Set the Audio Alert Pattern 3-1
 - 3.2 STW Alarm and SOG Alarm..... 3-2
 - 3.3 Wind Speed/Direction Alarms..... 3-3
 - 3.3.1 TWS alarm 3-3
 - 3.3.2 Wind shift alarm..... 3-3
 - 3.3.3 Apparent crosswind alarms 3-3
 - 3.4 Trip Alarm 3-4
 - 3.4.1 How to set the trip alarm 3-4
 - 3.4.2 How to reset the trip log 3-4
 - 3.5 Depth Alarm..... 3-5
 - 3.6 Low Voltage Alarm 3-5
 - 3.7 Water Temperature Alarm 3-6
 - 3.8 Engine Alarms 3-7
 - 3.9 Anchor Alarm..... 3-8
 - 3.10 CPA/TCPA Alarms 3-9

4. SYSTEM MENU	4-1
4.1 CAN bus (NMEA2000) Network Shared Settings	4-1
4.1.1 How to adjust the sharing level	4-2
4.2 How to Share Language and Brilliance Settings Between FI-70s.....	4-3
4.3 How to Set the Display Format	4-4
4.4 How to Adjust the Engine Settings.....	4-5
4.5 How to Set the Displayed Scale Range	4-7
4.6 How to Set Up the IF-NMEAFI (Option).....	4-8
4.6.1 IF-NMEAFI menu settings.....	4-8
4.6.2 How to test the IF-NMEAFI	4-9
4.6.3 How to reset the IF-NMEAFI to factory default settings.....	4-9
4.7 How to Setup the SC-30	4-10
4.8 How to Interpret the I/O Setup Menu	4-11
4.9 How to Set the Data Source(s)	4-12
4.10 How to Adjust (Calibrate) Incoming Data	4-13
4.11 How to Change the Language	4-14
4.12 How to Change the Units of Measurement	4-14
4.13 Other Items	4-15
5. INSTALLATION AND INITIAL SETTINGS	5-1
5.1 How to Mount the FI-70.....	5-1
5.1.1 Flushmount	5-2
5.1.2 Frontmount (Option).....	5-3
5.2 Wiring.....	5-5
5.2.1 How to connect the unit.....	5-5
5.2.2 How to connect to the Wind Transducers FI-5001/L.....	5-6
5.2.3 How to connect to the FI-5002 Junction Box (Option)	5-7
5.2.4 Terminator resistors	5-8
5.3 Input/Output PGNs.....	5-9
5.4 Post Installation Initial Settings (Initialization Menu)	5-10
6. MAINTENANCE, TROUBLESHOOTING.....	6-1
6.1 Preventive Maintenance.....	6-1
6.2 Troubleshooting	6-2
6.3 Alarm Log.....	6-2
6.4 Engine Error Icons	6-4
6.5 How to Diagnostically Test the FI-70	6-5
6.5.1 Self test	6-5
6.5.2 Keyboard test.....	6-6
6.5.3 Screen test.....	6-6
APPENDIX 1 MENU TREE	AP-1
SPECIFICATIONS	SP-1
PACKING LISTS.....	A-1
OUTLINE DRAWINGS.....	D-1
INTERCONNECTION DIAGRAMS.....	S-1
INDEX.....	IN-1

FOREWORD

A Word to the Owner of the FI-70

Congratulations on your choice of the FURUNO FI-70 Color Instrument. We are confident you will see why the FURUNO name has become synonymous with quality and reliability.

Since 1948, FURUNO Electric Company has enjoyed an enviable reputation for quality marine electronics equipment. This dedication to excellence is furthered by our extensive global network of agents and dealers.

This equipment is designed and constructed to meet the rigorous demands of the marine environment. However, no machine can perform its intended function unless operated and maintained properly. Please carefully read and follow the recommended procedures for operation and maintenance.

Thank you for considering and purchasing FURUNO equipment.

Features

By connecting the appropriate sensors, the FI-70 can provide various analog and digital navigation and environmental data, via a digital data display, using a high quality, backlit LCD. The sturdy, weather-proof case is built to stand up to even the harshest of environments.

The main features of the FI-70 are:

- Extensive navigational aid data, such as bearing, range, waypoints and current position, all on one compact display.
- Easy to view LCD with multi colored display.
- Easy to operate interface with multi function keys.
- Able to display various alarms and alerts. (Requires appropriate sensors.)
- Designed for NavNet TZtouch2 compatibility.
- Up to three engines may have their various data displayed.
- Simplified AIS function allows up to 25 vessels to be displayed.
- CAN bus (NMEA2000) network compatible.

With regards to CE declarations, please refer to our website (www.furuno.com), for further information on RoHS conformity declarations.

SYSTEM CONFIGURATION

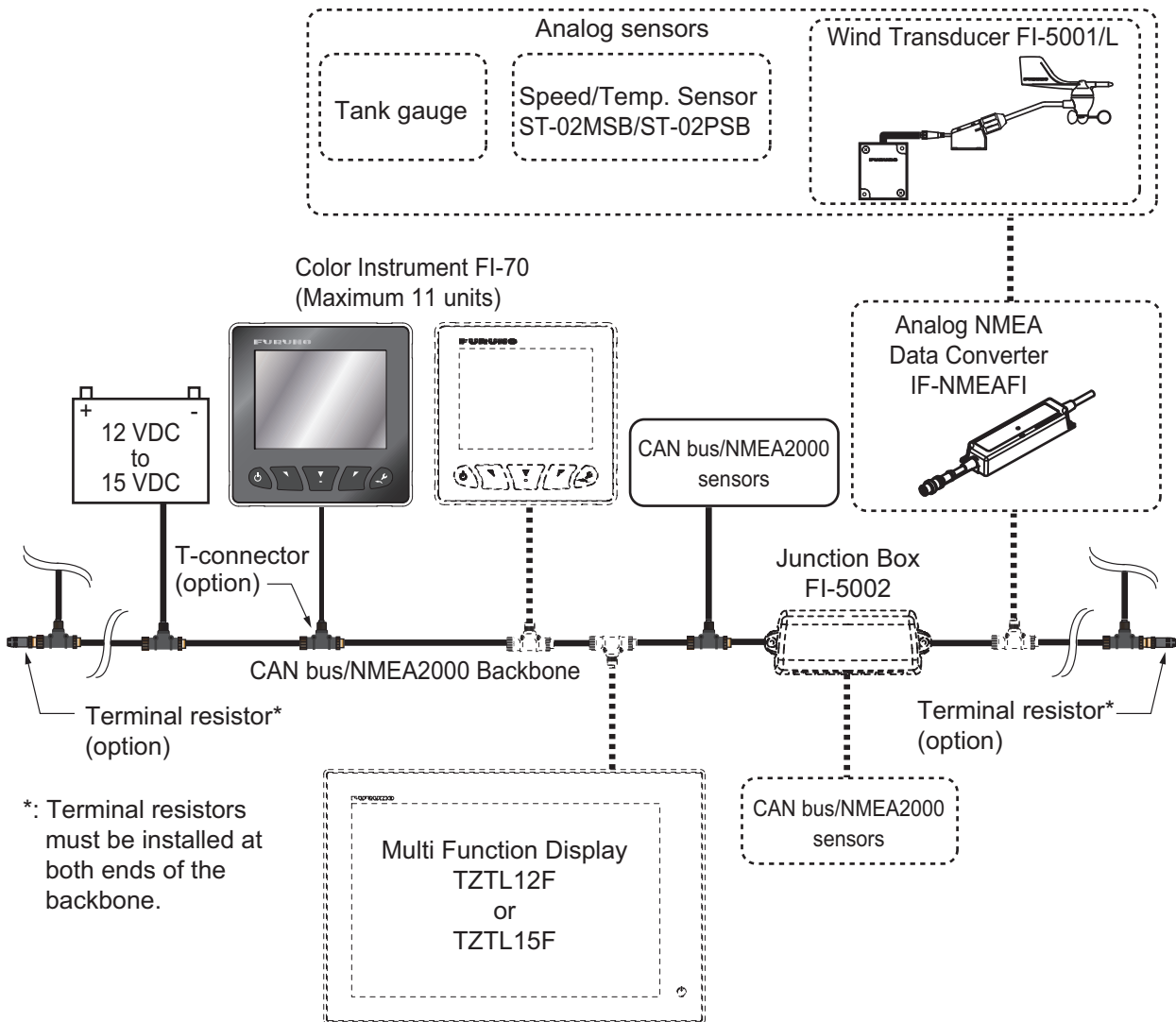

EQUIPMENT LISTS

Standard Supply

Name	Type	Code No.	Qty	Remarks
Color Instrument	FI-70	-	1	Includes soft cover.
Installation Materials	CP26-02000	000-027-046	1	Contains CP26-02001 installation materials.

Optional Supply

Name	Type	Code No.	Remarks
Analog NMEA Data Converter	IF-NMEAFI	-	
Wind Transducer	FI-5001	-	
	FI-5001L	-	
Junction Box	FI-5002	-	
Front Mount Kit	OP26-29	001-353-090	
Installation Materials	CP26-00300	000-010-511	For FI-5001, 30 m cable.
	CP26-00400	000-010-618	For FI-5001, 50 m cable.
Cable Assembly	FI-70-0600	001-490-200	CAN bus/NMEA2000 connector. 6 m "L" cable (micro, one side only).
	FI-50-CHAIN-0.3M	001-105-820-10	CAN bus/NMEA2000 connector. 30 cm "L" cable (micro).
	FI-50-CHAIN-1M	001-105-830-10	CAN bus/NMEA2000 connector. 1 m "L" cable (micro).
	FI-50-CHAIN-5M	001-105-840-10	CAN bus/NMEA2000 connector. 5 m "L" cable (micro).
	M12-05BM+05BF-010	001-105-750-10	CAN bus/NMEA2000 connector. 1 m cable (φ6, micro).
	M12-05BM+05BF-020	001-105-760-10	CAN bus/NMEA2000 connector. 2 m cable (φ6, micro).
	M12-05BM+05BF-060	001-105-770-10	CAN bus/NMEA2000 connector. 6 m cable (φ6, micro).
	CB-05PM+05BF-010	000-167-968-10	CAN bus/NMEA2000 connector. 1 m cable (φ6, mini).
	CB-05PM+05BF-020	000-167-969-10	CAN bus/NMEA2000 connector. 2 m cable (φ6, mini).
	CB-05PM+05BF-060	000-167-970-10	CAN bus/NMEA2000 connector. 6 m cable (φ6, mini).
NMEA Connector	SS-050505-FMF-TS001	000-168-603-10	Micro T-connector.
	NC-050505-FMF-TS001	000-160-507-10	Mini/micro T-connector.
	LTWMC-05BFFT-SL8001	000-168-605-10	Terminator resistor (micro, female).
	LTWMC-05BMMT-SL-8001	000-168-604-10	Terminator resistor (micro, male).
	LTWMN-05AFFT-SL8001	000-160-509-10	Terminator resistor (mini, female).
	LTWMN-05AMMT-SL8001	000-160-508-10	Terminator resistor (mini, male).
	FRU-0505-FF-IS	001-077-830-10	In-line terminator.
Operator's Manual	OME-72810-*	000-190-062-1*	English

This page is intentionally left blank.

1. OPERATION AND CONTROLS OVERVIEW

1.1 Controls

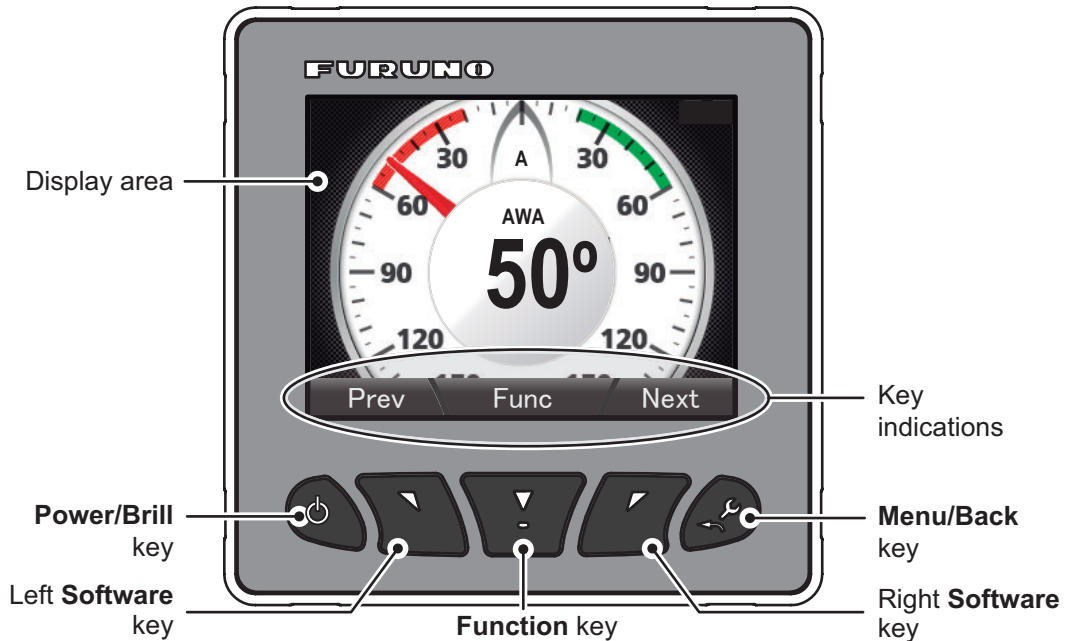

The information shown in the display area varies depending on the category chosen to be displayed.

Key	Functions
Power/Brill key	Turn power on/off; open the [Brilliance] setting window.
Software keys	Go back /forward one page; move the cursor; reduce/increase setting value.
Function key	Confirm selection; change displayed data (not available in some display modes).
Key indications	Show the operative function for the Software and Function keys. Press any key to display the indicators. If there is no operation, the indicators are minimized after a short period of time, however, they are always displayed when a menu is open. The indications vary, depending on the displayed screen/menu.
Menu/Back key	Open main menu; return one level in the menu; cancel.

1.2 How to Turn the Power On/Off

The FI-70 turns on when the CAN bus/NMEA2000 network is powered. The FI-70 will undergo a self-test, then display the last-used screen if the test is completed satisfactorily.

Press and hold the **Power/Brill** key to turn the FI-70 off. The message "Turning OFF in 3 seconds" is displayed. Hold the key for three seconds. Early release of the **Power/Brill** key will abort the shutdown. To turn the FI-70 on again, press the **Power/Brill** key.

1.3 How to Adjust the Screen Brilliance

Press the **Power/Brill** key to show the [Brilliance] setting window. The **software** keys decrease or increase brilliance.

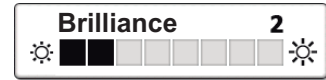

Pressing the **Power/Brill** key repeatedly cycles through the brilliance levels.

Press the **function** key to switch between Day and Night modes.

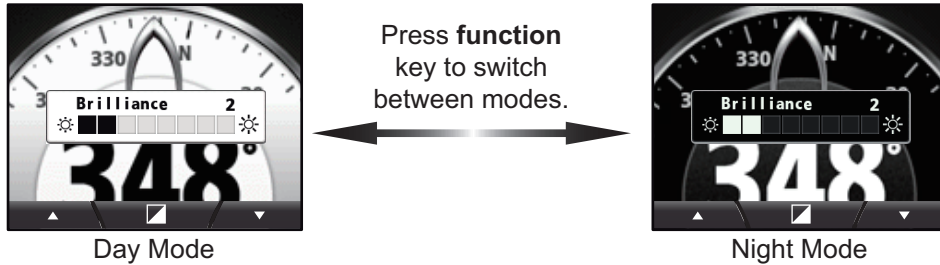

1.4 Menu Overview

1. Press the **Menu/Back** key to display the main menu. The main menu contents change according to the current category (See section 1.7 for more information on categories). In the example below, the wind category is displayed.

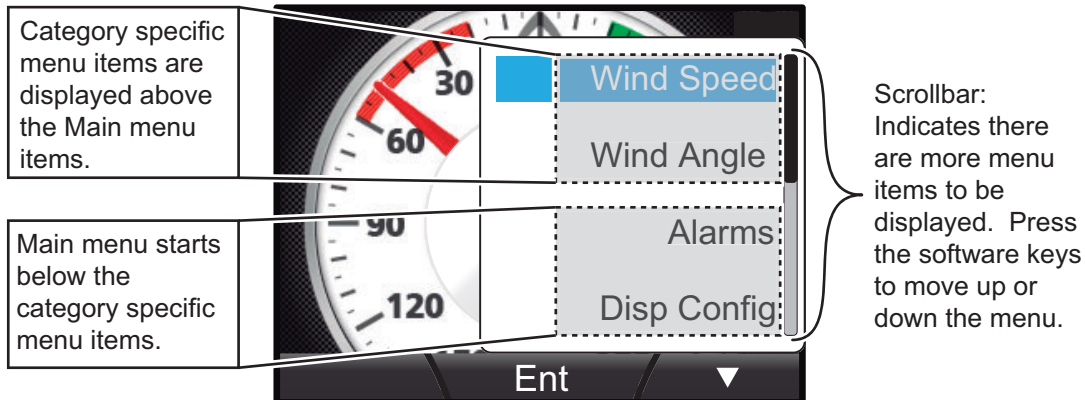

2. Press the right **software** key to select the next item down in the menu, or press the left **software** key to select the next item up in the menu. The menu item currently selected is highlighted in blue. In the example above, [Wind Speed] is selected.

Note: The key indications for the **software** keys are blank if there are no more options in that direction of the menu. In the above example, the menu has no options in the up direction.

3. Press the **function** key to open the selected menu. For the purpose of this example, the [Wind Speed] menu is opened.

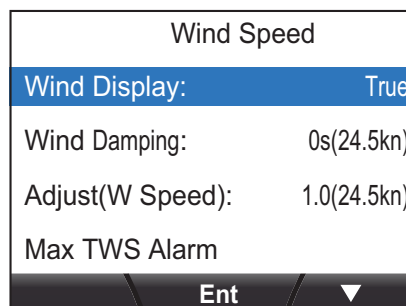

4. Press the **software** keys to select the item you wish to adjust, then press the **function** key. The setting options pop-up window is displayed.

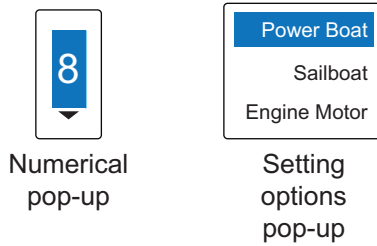

5. Press the left **software** key to select the next item above your current selection, or increase the value for the current selection. Press the right **software** key to select the next item below your current selection, or decrease the value for the current selection.
6. Press the **function** key to apply the changes, then press the **Menu/Back** key to close the menu.

Main menu items

The main menu has the following menu items which appear in all menus, regardless of the category selected:

Menu item	Description
[Alarms]	Set alarms. (See section 6.3 for details on the [Alarm] menu.)
[Disp Config]	Change the information displayed on each page. (See section 1.7 for more information.)
[Alarm Log]	Open the alarm log. (See section 6.3 for more information.)
[Sensor in Use]	Displays a list showing the sensors currently set in the [Data Source] menu.
[System]	Change the FI-70 settings. (See chapter 4 for more information.)

For category specific menus, see the appropriate category in chapter 2.

1.5 How to Turn Key Beeps On/Off

1. Press the **Menu/Back** key to open the main menu.
2. Press the right **software** key to scroll down the menu and select [System], then press the **function** key.
3. [Key Beep] is already selected, press the **function** key.
4. Press the **software** keys to select [ON] or [OFF], as appropriate, then press the **function** key to apply the setting.
5. Press the **Menu/Back** key to close the menu.

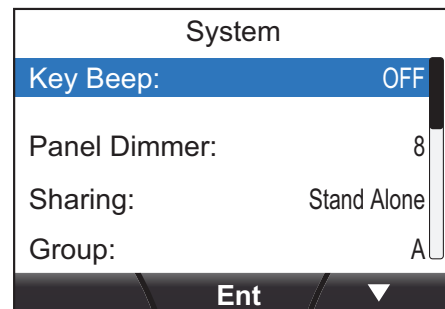

1.6 How to Adjust the Panel Dimmer (Control Key Panel Backlights)

1. Press the **Menu/Back** key to open the main menu.
2. Press the **software keys** to scroll down the menu and select [System], then press the **function key**.
3. Press the **software keys** to scroll through the menu and select [Panel Dimmer], then press the **function key**.
4. Press the **software keys** to adjust the dimmer as appropriate, then press the **function key** to apply the setting.
5. Press the **Menu/Back** key to close the menu.

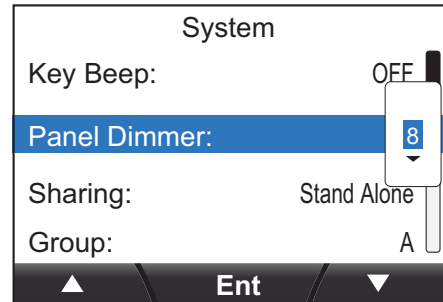

1.7 Screen Categories and Page Setup

The FI-70 can display the information categories shown in the figures below, provided a sensor for the appropriate information is connected.



Compass



Speed

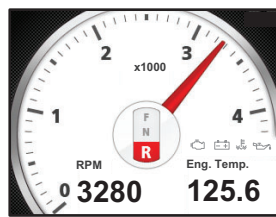

Engine

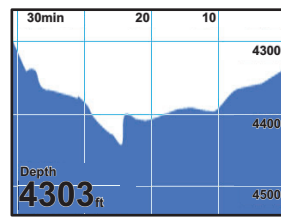

Graphs

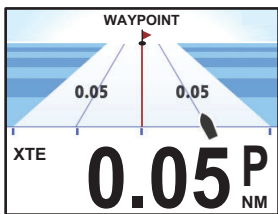

Highway

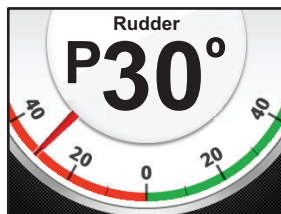

Rudder

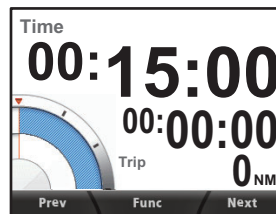

Timers



Wind

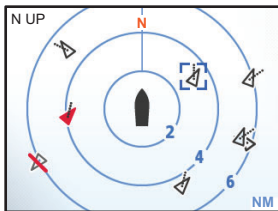

AIS

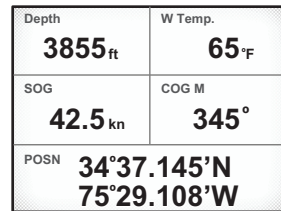

Custom data box

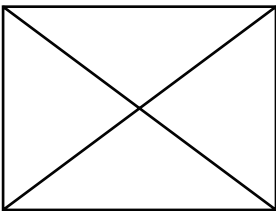

OFF

1.7.1 How to change the displayed page

The FI-70 can display up to seven different pages of information. Use the **software** keys to change pages backwards and forwards between the pages.

The number of the current page is displayed as a large numeral in the center of the screen for three seconds after the page is displayed.

Pages with no display information selected are skipped. In the example below, no information is selected to be displayed on pages 2, 5 or 7.

Pressing the right **software** key will display, in order, Engine → Compass → Speed → Wind direction → Engine, while pressing the left **software** key will display the pages in reverse order.

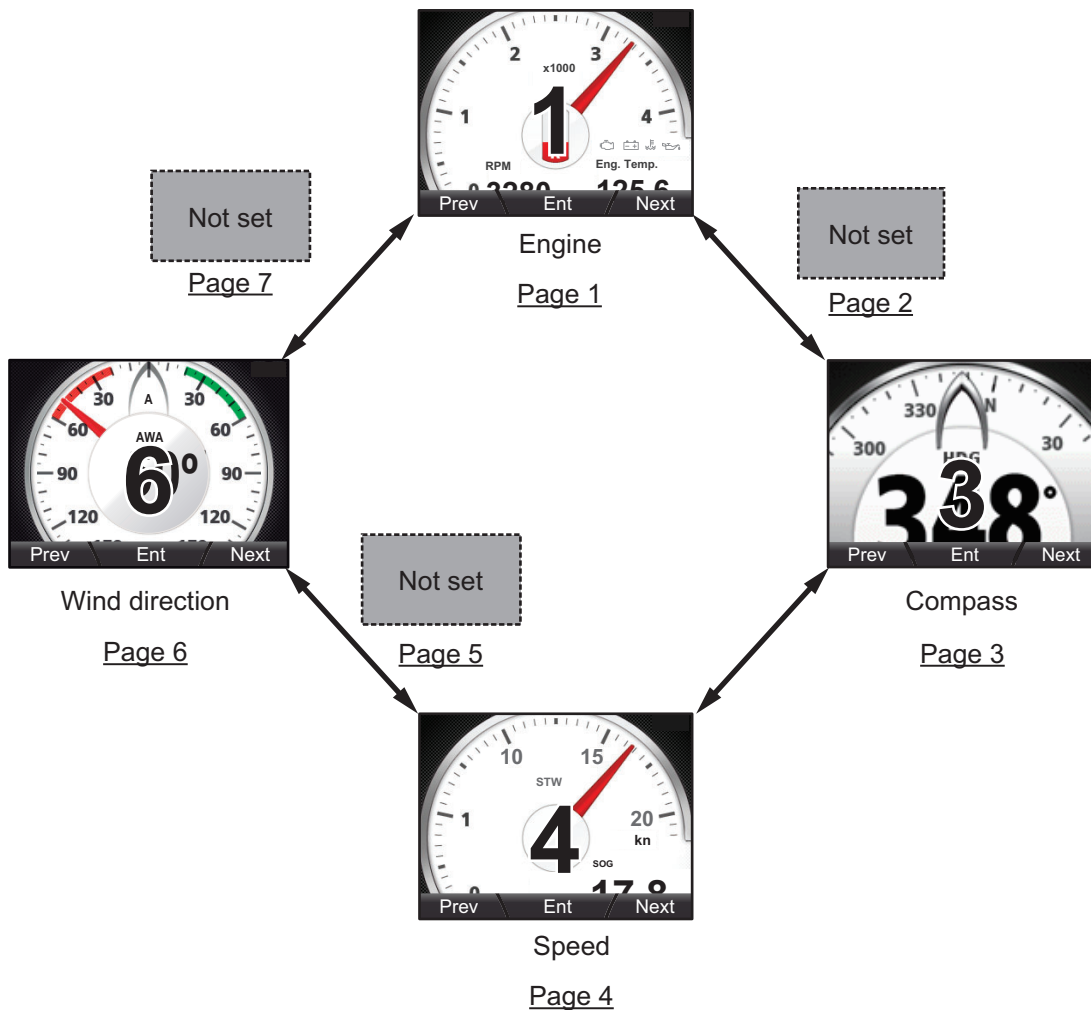

1.7.2 How to set up pages

The FI-70 is capable of displaying seven pages of category information.

The procedure below outlines how to set up a page.

1. Press the **Menu/Back** key to display the main menu.
2. Press the right **software** key to scroll down the menu and highlight [Disp Config], then press the **function** key.

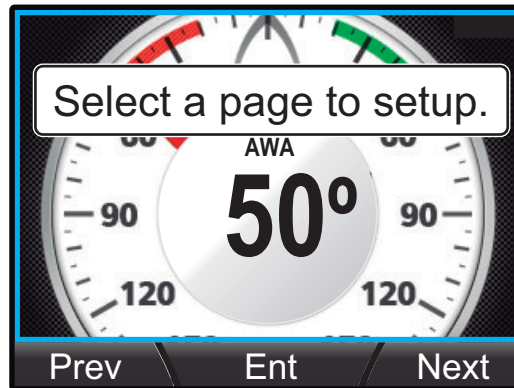

3. Press the **software** keys to select the appropriate page. The page number is displayed at the center of the screen for three seconds after each page change.
4. Press the **function** key to display the category selection screen.

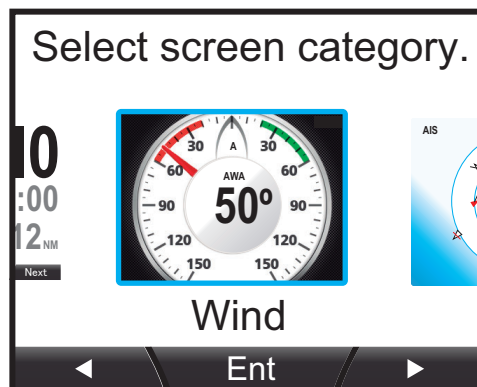

5. Press the **software** keys to select the appropriate category to display, then press the **function** key. The current selection is highlighted with a blue box.
6. Press the **function** key to set the selected category (and screen if applicable) for the selected page. Some categories have several display screens available. See chapter 2 for further details on available screens for the selected category.
7. If the category selected at step 5 was [Graph], set the graph data display as follows:
 - 1) Press the **software** keys to select [1Graph] or [2Graphs] as appropriate, then press the **function** key. For this example, [2Graphs] is chosen.

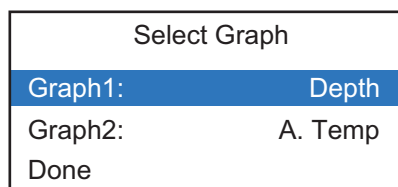

- 2) Press the **software** keys to select the graph to setup, then press the **function** key.

- 3) Press the **software** keys to select the appropriate data to display, then press the **function** key.

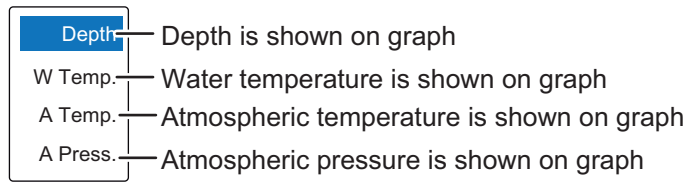

- 4) Repeat steps 2) and 3) for the second graph.
- 5) Press the right **software** key to select [Done], then press the **function** key to apply the changes.
- 6) Press the **Menu/Back** key once to close the menu.
8. Press the **Menu/Back** key to exit the [Display Config] menu.

1. OPERATION AND CONTROLS OVERVIEW

This page is intentionally left blank.

2. DISPLAY CATEGORIES AND CATEGORY SPECIFIC MENUS

This chapter explains the various menu operations and on-screen indications for each display category.

Depending on the data currently selected to be displayed, the analog and digital data displayed on-screen may differ.

2.1 Compass Category



The compass needle indicates the current heading in this category. The compass scale rotates to show the heading as you turn the ship.

Press the **function** key to cycle through the following data on the Compass display:

Displayable data	Description
HDG	Displays the current heading.
HDG Avg.*	Displays the average heading.
HDG Tack	Displays the projected heading on next tack.

*: The average is calculated from when the FI-70 is turned on. All calculations are reset when the power is turned off.

2.2 Speed Category

Speed Thru Water (STW) screen



Speed Over Ground (SOG) screen



Current speed

Press the **function** key to change data displayed

This category displays the ship speed data on the needle meter. When there is no speed data input to the FI-70, the current speed indicator (needle) is not displayed.

The Speed category has two available screens: STW and SOG. See "How to set up pages" on page 1-6 to set the screens.

Press the **function** key to cycle through the following data on the Speed display:

Displayable data	Description
STW	Displays Speed Through Water (STW).
STW Max*	Displays maximum STW.
STW Avg.*	Displays average STW.
SOG	Displays Speed Over Ground (SOG).
SOG Max*	Displays maximum SOG.
SOG Avg.*	Displays average SOG.
VMG	Displays Velocity Made Good (VMG). Note: VMG is unavailable in SOG mode.

*: The average and maximum values are calculated from when the FI-70 is turned on. All calculations for average and maximum are reset when the power is turned off.

2.3 Engine Category

NOTE: Data shown in the engine category is input from engine sensors. Always check any malfunction at the engine, do not rely solely on the FI-70 indications.

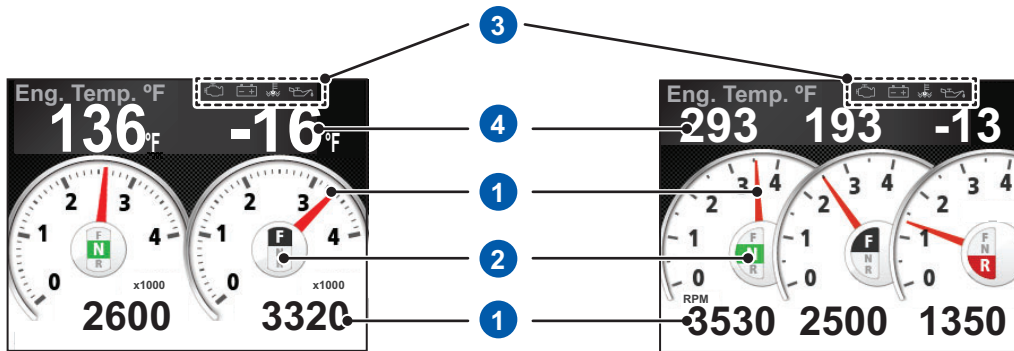
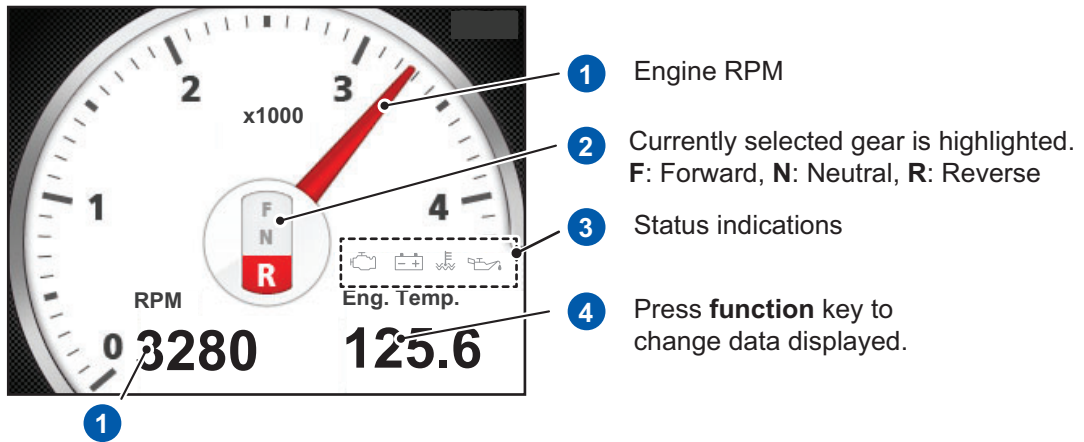

Two engine display

Three engine display

This category displays various engine information for up to three engines.

For details on engine status indicators, see "Engine Error Icons" on page 6-4.

Press the **function** key to cycle through the following data on the Engine display:

Displayable data	Description
Eng. Temp.	Displays the engine temperature.
Fuel Used	Displays the amount of fuel used.
Fuel Rate	Displays the consumption rate of fuel.
Boost	Displays the boost psi.
Eng. Hour	Displays the engine hours.
Oil Press.	Displays the oil pressure.
Oil Temp.	Displays the oil temperature.
Coolant P	Displays the coolant pressure.
E Load	Displays the engine load.
Gear Oil T	Displays the gear oil temperature.
Gear Oil P	Displays the gear oil pressure.

2.4 Graph Category

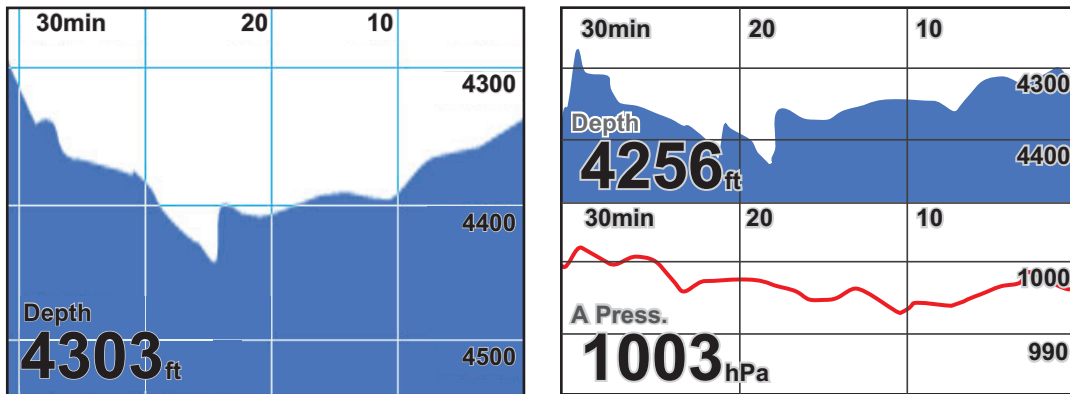

The graph category displays preselected sensor data in graph format. Up to two graphs can be displayed simultaneously. The following data may be selected for display in graph format.

- Depth
- W Temp. (Water temperature)
- A Temp. (Atmospheric temperature)
- A Press. (Atmospheric pressure)

The menu items displayed for the Graph category are dependent on the currently graphed items. In the above right example, the menu will display [Depth Graph] and [A Press Graph]. To adjust the graphed interval and range, see the procedure below.

To set the graph data to be displayed, see "How to set up pages" on page 1-6.

How to adjust the graphed interval and range

The graphed interval and range may be adjusted for all graphs.

1. With the [Graph] page displayed, press the **Menu/Back** key.

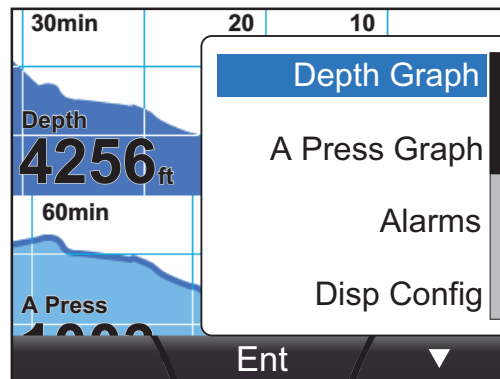

2. Press the **software** keys to select the graph to adjust, then press the **function** key.
3. Press the **software** keys to select the appropriate variable to change.
[Period]: Adjusts the graphed interval.
[Range]: Adjusts the graphed range.
4. Using the **software** keys, adjust the [Period] and [Range] appropriately. Press the **function** key to save the adjustments.
5. Press the **Menu/Back** key to close the menu.

2.5 Highway Category

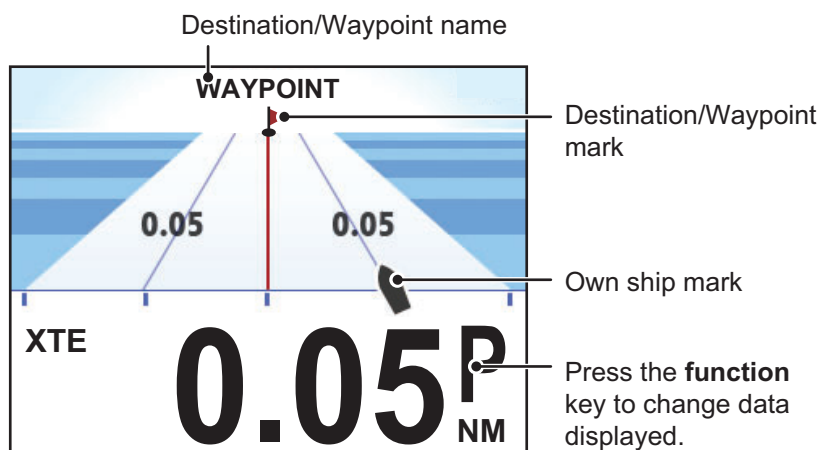

The highway display provides a graphic presentation of your boat's track along the intended course, toward a waypoint.

Press the **function** key to cycle through the following data on the Highway display:

Displayable data	Description
XTE	Displays the XTE (Cross Track Error).
WPT	Displays the co-ordinates for the next waypoint.
RNG	Displays the distance to the next waypoint.
BRG	Displays the current bearing.

There is no category specific menu for this category.

2.6 Rudder Category

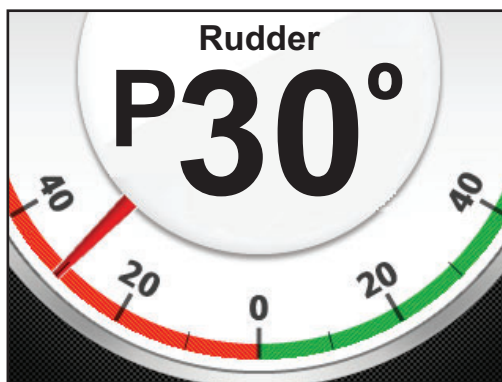

The Rudder category shows the current rudder angle, along with the indicators "P" for port and "S" for starboard.

This category has no specific menus and the **function** key has no function.

2.7 Timer Category



Countdown Timer1

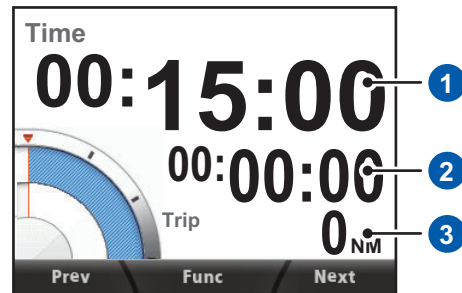

Countdown Timer2

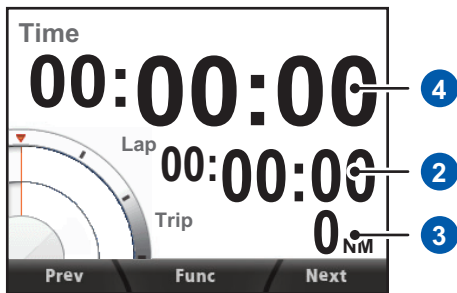

Countup Timer

1	Countdown Timer
2	Lap time
3	Trip meter
4	Countup Timer

The Timer category has three available timers to select from, as indicated in the figure above. To select the desired timer, see "How to set up pages" on page 1-6.

[Countdown Timer1] and [Countdown Timer2] both have a maximum time of 15 minutes. The [Trip] indicator on [Countdown Timer2] and on the [Countup Timer] keeps track of the distance traveled (requires appropriate sensors).

Note: All timers are paused and the normal display indications are restored if the **Menu/Back** key is pressed with any timer open.

2.7.1 How to use the timers

With the timer screen displayed, press the **function** key to show the [Func] key indications. Press the **function** key again to start the selected timer.

The [Countdown Timer2] and [Countup] timer begin to measure distance.

With the timer active, press the right **software** key to record a lap time. Press the left **software** key to reset the timer to nearest minute.

Press the **function** key at any time to stop the timer. The **Menu/Back** key may also be used to stop the timer.

With the timer stopped, press the right **software** key to reset the times (counter and lap) and distance.

To restart the timer, press the **function** key.

2.7.2 How to adjust the timers

1. With the timer screen displayed, press the **function** key to show the [Func] key indications.

The left **software** key indication is blank for the [Countup] timer.



Note: The [Countup] timer does not require setup. When using the [Countup] timer, skip to step 4.

2. Press the left **software** key to open the [Setup] window. The time will flash, indicating it can be changed.

Time flashes to indicate it is changeable

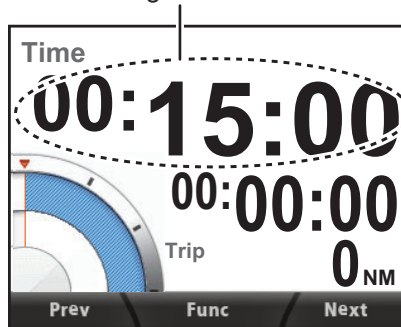

3. Press the **software** keys to decrease or increase the time, then press the **function** key to apply the changes.
4. Press the **function** key to start the timer.

2.8 Wind Category

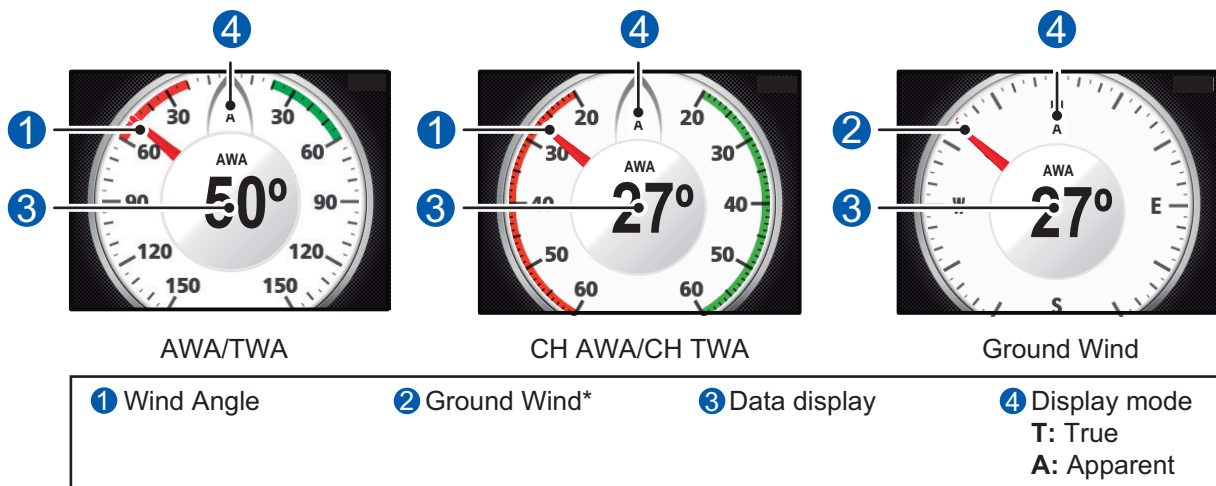

*: Heading, AWA/AWS and STW data are required to display Ground Wind.

This category displays various wind data. There are three wind modes available, as shown in the figure above. The apparent and true wind data can be assigned on each page.

Press the **function** key to cycle through the following data in the [Wind] category:

Displayable data	Description
AWA	Displays Apparent Wind Angle (AWA). (When the apparent wind data is displayed)
AWS	Displays Apparent Wind Speed (AWS). (When the apparent wind data is displayed)
TWA	Displays True Wind Angle (TWA). (When the true wind data* ¹ is displayed)
TWS	Displays True Wind Speed (TWS). (When the true wind data* ¹ is displayed)
TWS Max.	Displays the maximum value* ² of the TWS. (When the true wind data* ¹ is displayed)
Beaufort	Displays wind strength in Beaufort units.

*¹: Note that the AWA, AWS and ship's speed (STW or SOG) data are required to display true wind (ship's speed data priority: STW > SOG).

*²: The maximum value is calculated from when the FI-70 is turned on. The maximum value is reset when the power is turned off.

2.9 AIS Category

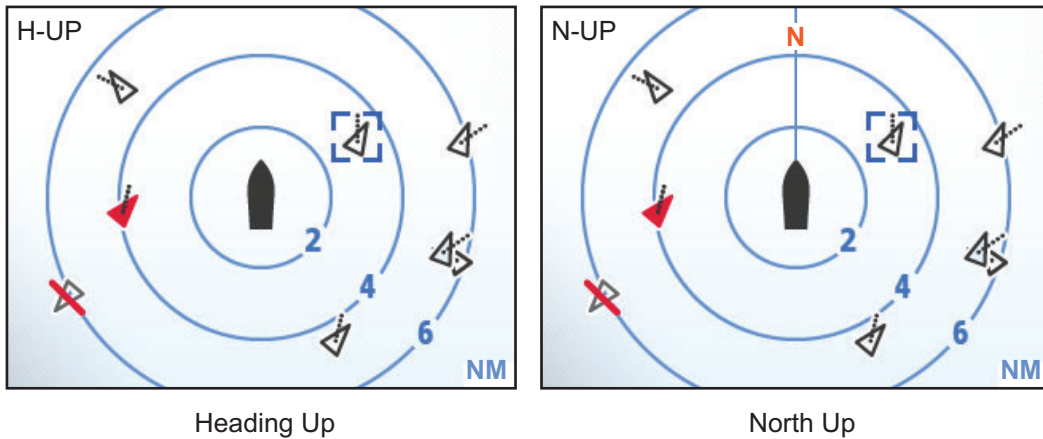

The AIS category displays basic AIS data such as bearing, range, lost and dangerous targets. The maximum number of targets which may be displayed is 25, in order from closest to farthest from own ship.

Range rings are fixed at 2 NM, 4 NM and 6 NM.

There are two orientations available:

- [Heading Up] - Displays the targets and own ship with the heading oriented upwards.
- [North Up] - Displays the targets and own ship with North oriented upwards.

Note: The AIS category is a simplified AIS, with limited function and capacity. Only Class A and Class B AIS targets are displayed. Do not rely solely on the FI-70 indications for information about nearby targets.

AIS symbols and their meanings

The AIS symbols displayed may change, depending on the target's conditions, as shown in the table below. The targets are displayed as a triangular symbol, with a line extending from the triangle. The line indicates the estimated COG (Course Over Ground) for the target and changes direction accordingly.

AIS Symbol	Meaning
	Activated target symbol.
	Dangerous target symbol. Any targets entering the danger zone change to dangerous targets. This symbol is displayed as a flashing symbol.
	Lost target symbol. Targets whose data has been lost by the AIS are displayed in this manner. This symbol is displayed as a flashing symbol.
	Uncertain target symbol. The CPA/TCPA for this target cannot be calculated. CPA is the Closest Point of Approach, TCPA is the Time to Closest Point of Approach.

2.9.1 How to display AIS target details

1. Press the **function** key to show the AIS key indications, as shown in the figure below.

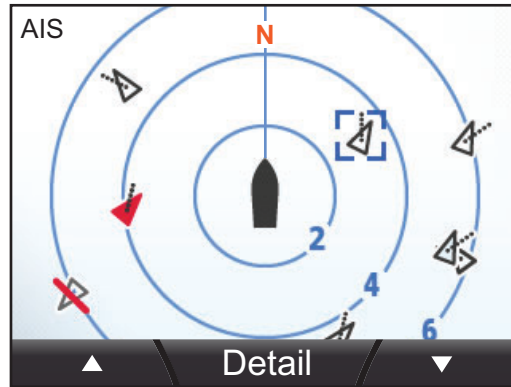

2. Press the left **software** key to cycle through the targets, in order, from closest to farthest. Press the right **software** key to cycle through the targets, in order, from farthest to closest.
3. Press the **function** key to select a target and display its details.

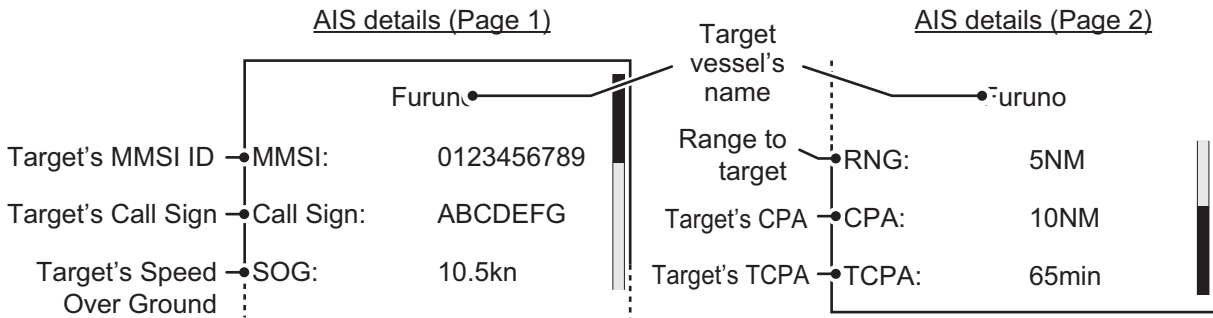

Press the right **software** key to show the hidden items RNG, CPA and TCPA.

2.9.2 How to change AIS orientation

With the AIS screen displayed, press the **Menu** key to display the [AIS] menu.

[Orientation] may be set to [Heading Up] or [North Up].

1. Select [Orientation], then press the **function** key.

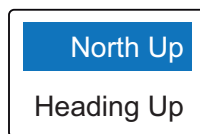

2. Press the **software** keys to select the appropriate orientation, then press the **function** key.
3. Press the **Menu/Back** key to close the menu.

2.10 Custom Box Category

Depth	W Temp.
3855 ft	65 °F
SOG	COG M
42.5 kn	345 °
POSN	34°37.145'N 75°29.108'W

The Custom Box category allows you to customize the display, dividing the display area with up to 6 boxes. The boxes may be set up to display all manner of sensor data of simple graphic data (such as roll and pitch).

The Custom Box category may be selected from the [Disp Config] menu. See "How to set up pages" on page 1-6 for details.

The Custom Box category has several preset screens available, all of which are fully customizable. The preset screens show data related to their genre, as shown in the table below.

Preset screen	Information shown
[Fishing]	Depth, W Temp., SOG, COG M/T, POSN
[Sailing]	POSN, AWS
[Ship]	SOG, COG M/T, POSN
[Navigation]	BRG M/T, RNG, COG M/T, SOG, XTE
[Environment]	A Press., A Temp., Dew Point
[Engine]	<ul style="list-style-type: none"> • Where [Number of Engine] is set to 1 Oil Temp., Eng. Temp., Fuel Rate, Boost • Where [Number of Engine] is set to 2 Oil Temp., Eng. Temp., Fuel Rate • Where [Number of Engine] is set to 3 Oil Temp., Eng. Temp.
[Custom Layout]	Six unassigned boxes

2.10.1 How to customize the data boxes

With the Custom Box screen displayed, the key indications show "Edit" as the **function** key function.

1. Press the **function** key to begin customizing the boxes. The selected box is highlighted in blue.

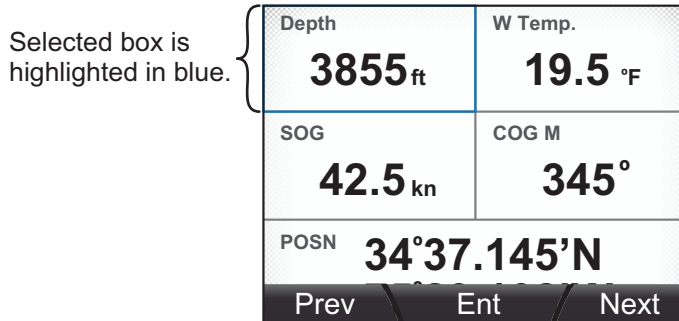

2. Press the **software** keys to select the box to be customized, then press the **function** key.

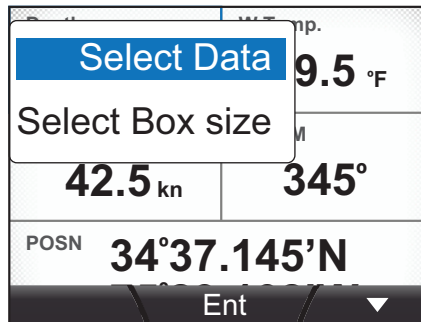

3. Press the **software** keys to select [Select Data], then press the **function** key.

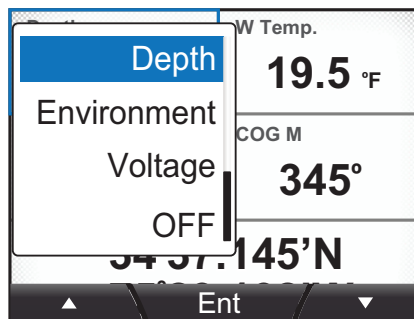

The available options are shown in paragraph 2.10.3.

4. With the box highlighted, press the **software** keys to select which page to display in the data box, then press the **function** key to apply the new settings.

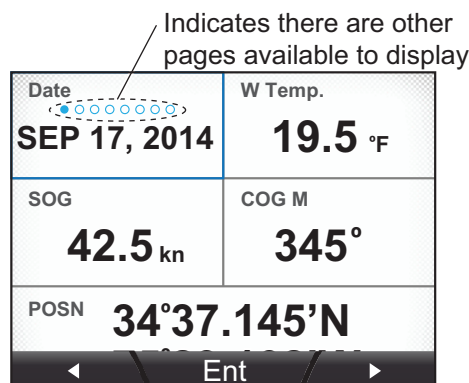

5. Press the **Menu/Back** key to close the edit screen.

2.10.2 How to resize data boxes

1. With the Custom Box category displayed, press the **function** key.
2. Press the **software** keys to highlight the data box to be resized, then press the **function** key.
3. Press the **software** keys to select [Select Box Size], then press the **function** key.

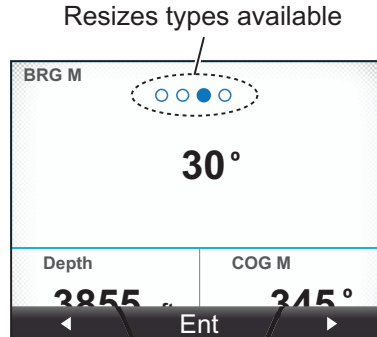

4. Press the left **software** key to select a smaller size data box or press the right **software** key to select a larger size box, then press the **function** key to apply the settings.
When making the data box larger, surrounding boxes are covered and will not be displayed.
When making the data box smaller, previously covered boxes are uncovered and will be displayed.

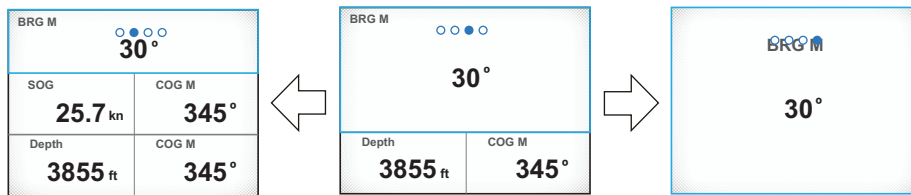

Box size has been made smaller, uncovering SOG and COG M.

Box size has been made larger, covering Depth and COG M.

For displayable data box sizes, according to category, see paragraph 2.10.3.

5. Press the **Menu/Back** key to close the menu.

2. DISPLAY CATEGORIES AND CATEGORY SPECIFIC MENUS

2.10.3 Data which may be displayed in custom boxes

The table below shows the data which may be displayed in custom boxes and the box sizes available when resizing the boxes.

Data type	Displayed data		Box sizes available (Height × Width)
Speed	STW	SOG	1×1, 1×2, 2×2, 3×2
	STW Max*1	SOG Max*1	
	STW Avg.*1	SOG Avg.*1	
	VMG		
Wind	AWS	AWA	1×1, 1×2, 2×2, 3×2
	TWS	TWA	
	TWS Max*1	Beaufort	
	GWD M(T)		
Heading	HDG M(T)	HDG Tack M(T)	1×1, 1×2, 2×2, 3×2
	HDG Avg. M(T)*1	ROT	
Course	COG M(T)		1×1, 1×2, 2×2, 3×2
Navigation	BRG M(T)	Odometer	1×1, 1×2, 2×2, 3×2
	RNG	ETA Time	
	Trip		
	WPT	POSN	1×1, 1×2
	XTE		1×1, 2×1*2, 1×2, 2×2*2, 3×2*2
	ETA Date		1×1, 1×2, 2×2
Boat	Rudder		1×1, 1×2, 2×2, 3×2
	Trim Tabs		2×1*2
	Roll/Pitch		2×2*2
Engine	Engine RPM	Fuel Used	1×1, 1×2, 2×2, 3×2
	Eng. Trim	Fuel Rate	
	E Load	Eng. Hour	
	Gear Oil P	Gear Oil T	1×1*2, 2×1*2, 1×2, 2×2, 3×2
	Boost	Eng. Temp.	
	Oil Temp.	Oil Press.	
	Coolant P		
Tank	T1 thru T6 tank information		1×1*2, 2×1*2, 1×2, 2×2, 3×2
Depth	Depth		1×1, 1×2, 2×2, 3×2
Environment	Date		1×1, 1×2, 2×2
	A Press.		1×1, 1×2, 2×2, 3×2
	Time	Humidity	
	W Temp.	Wind Chill	
	A Temp.	Dew Point	
Voltage	Volts		1×1*2, 2×1*2, 1×2, 2×2, 3×2
OFF	Blank data box		1×1

*1: The average and maximum values are calculated from when the FI-70 is turned on. All calculations for average and maximum are reset when the power is turned off.

*2: These items are shown in simplified format when displayed in the custom data boxes.

3. ALARMS

This section explains how to set and use the [Alarms] menu. Most alarms may be accessed from the respective category menu, however, settings made in the [Alarms] menu are applied to each category. To access and set alarm from the [Alarms] menu, do the following:

1. Press the **Menu/Back** key to open the menu.
2. Press the **software** keys to select [Alarms], then press the **function** key to show the [Alarms] menu.

When an alarm event occurs, an audio alert sounds, the alarm icon  is displayed and an alarm message is shown in a pop-up window. (For further information on alarm messages and their meanings, see "Alarm Log" on page 6-2.)

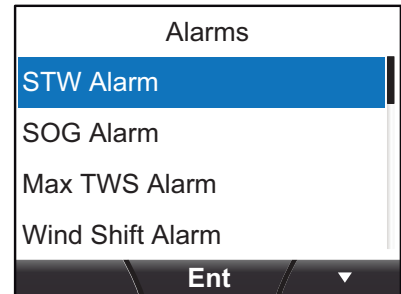

To acknowledge an alarm, stop the audio alert and close the pop-up window, press the **function** key. If the cause of the alarm is not rectified, the audio alert sounds and the alarm pop-up is displayed again after a short period of time. In the case of multiple alarms, press the **function** key several times to clear the pop-ups.

All alarms which have occurred since the FI-70 was turned on are stored in the [Alarm Log]. See "Alarm Log" on page 6-2.)

3.1 How to Set the Audio Alert Pattern

The audio alert pattern can be set for each alarm using the following procedure.

1. Access the [Alarms] menu, using the procedure outlined above.
2. Press the **software** keys to select the alarm you wish to set, then press the **function** key. For the purpose of this example, [STW Alarm] is chosen.

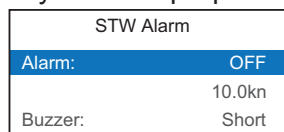

Appear as gray and unselectable until alarm is turned ON.

3. [Alarm] is highlighted, press the **function** key.
4. Select [ON], then press the **function** key. The grayed items are now visible and may be set.
5. Select [Buzzer], then press the **function** key. The audio alert options are displayed in a pop-up window.

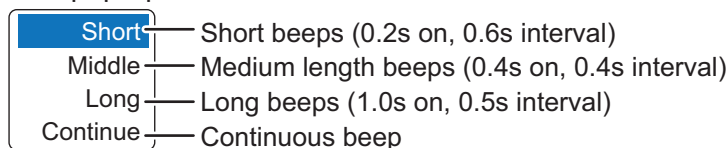

6. Select the appropriate option, then press the **function** key.
7. Press the **Menu/Back** key twice to close the menu.

See the respective section for how to set the other parameters for each alarm.

3.2 STW Alarm and SOG Alarm

The STW and SOG alarms set a high speed or low speed alarm threshold. When the vessel speed goes over the high speed threshold, or below the low speed threshold, the alarm is activated.

1. Access the [Alarms] menu, using the procedure outlined on page 3-1.
2. Press the **software** keys to select [STW Alarm] or [SOG Alarm], then press the **function** key.
3. [Alarm] is highlighted, press the **function** key.
4. Select [OFF], [High] or [Low] as appropriate, then press the **function** key.
 - [OFF]: Disable the alarm. Proceed to step 7.
 - [High]: Enable the high speed alarm.
 - [Low]: Enable the low speed alarm.
5. Press the **software** keys to select the speed threshold setting, then press the **function** key.

STW Alarm	
Alarm:	Low
	10.0kn
Buzzer:	Short

Speed threshold setting for STW or SOG

6. Press the **software** keys to set the threshold as appropriate, then press the **function** key to apply the changes.
7. Press the **Menu/Back** key twice to close the menu.

3.3 Wind Speed/Direction Alarms

3.3.1 TWS alarm

The TWS alarm sets a true wind speed alarm threshold. When the TWS goes over the set threshold, the alarm is activated.

1. Access the [Alarms] menu, using the procedure outlined on page 3-1.
2. Press the **software** keys to select [Max TWS Alarm], then press the **function** key.
3. [Alarm] is highlighted, press the **function** key.
4. Select [OFF] or [ON] as appropriate, then press the **function** key.
 - [OFF]: Disable the alarm. Proceed to step 7.
 - [ON]: Enable the alarm.
5. Press the **software** keys to select the threshold, then press the **function** key.
6. Press the **software** keys to set the threshold as appropriate, then press the **function** key to apply the changes.
7. Press the **Menu/Back** key twice to close the menu.

3.3.2 Wind shift alarm

The wind shift alarm alerts you when the wind direction shifts radically.

1. Access the [Alarms] menu, using the procedure outlined on page 3-1.
2. Press the **software** keys to select [Wind Shift Alarm], then press the **function** key.
3. [Alarm] is highlighted, press the **function** key.
4. Select [OFF] or [ON] as appropriate, then press the **function** key.
 - [OFF]: Disable the alarm. Proceed to step 7.
 - [ON]: Enable the alarm.
5. Press the **Menu/Back** key twice to close the menu.

3.3.3 Apparent crosswind alarms

The apparent crosswind alarms are activated when the crosswind speed from port or starboard-side goes over the set threshold.

1. Access the [Alarms] menu, using the procedure outlined on page 3-1.
2. Press the **software** keys to select [High AWA Alarm] (Starboard) or [Low AWA Alarm] (Port), then press the **function** key.
3. [Alarm] is highlighted, press the **function** key.
4. Select [OFF] or [ON] as appropriate, then press the **function** key.
 - [OFF]: Disable the alarm. Proceed to step 7.
 - [ON]: Enable the alarm.
5. Press the **software** keys to select the threshold, then press the **function** key.
6. Press the **software** keys to set the threshold as appropriate, then press the **function** key to apply the changes.
7. Press the **Menu/Back** key twice to close the menu.

3.4 Trip Alarm

The trip alarm is activated when the total distance traveled reaches the set threshold. The total distance traveled is calculated from the moment the FI-70 is powered for the first time. This distance is stored in the trip log.

3.4.1 How to set the trip alarm

1. Access the [Alarms] menu, using the procedure outlined on page 3-1.
2. Press the **software** keys to select [Trip Alarm], then press the **function** key.
3. [Alarm] is highlighted, press the **function** key.
4. Select [OFF] or [ON] as appropriate, then press the **function** key.
 - [OFF]: Disable the alarm. Proceed to step 7.
 - [ON]: Enable the alarm.
5. Press the **software** keys to select the threshold, then press the **function** key.
6. Press the **software** keys to set the threshold as appropriate, then press the **function** key to apply the changes.
7. Press the **Menu/Back** key twice to close the menu.

3.4.2 How to reset the trip log

1. With a data box showing [Trip] displayed, press the **Menu/Back** key.
2. Press the **software** keys to select [Trip], then press the **function** key.
3. Press the **software** keys to select [Clear], then press the **function** key. The FI-70 displays the following confirmation message.

Clear trip log.
Are you sure?

4. To reset the trip log, press the left **software** key. To abandon the log reset, press the right **software** key.
5. Press the **Menu/Back** key to close the menu.

3.5 Depth Alarm

The depth alarm activates when the depth is either above or below the set threshold.

1. Access the [Alarms] menu, using the procedure outlined on page 3-1.
2. Press the **software** keys to select [Depth Alarm], then press the **function** key.
3. [Alarm] is highlighted, press the **function** key.
4. Select [OFF], [Deep] or [Shallow] as appropriate, then press the **function** key.
 - [OFF]: Disable the alarm. Proceed to step 7.
 - [Deep]: Activates the alarm when the depth is more than the threshold.
 - [Shallow]: Activates the alarm when the depth is less than the threshold.
5. Press the **software** keys to select the threshold, then press the **function** key.
6. Press the **software** keys to set the threshold as appropriate, then press the **function** key to apply the changes.
7. Press the **Menu/Back** key twice to close the menu.

3.6 Low Voltage Alarm

The low voltage alarm is activated when the input voltage to the FI-70 drops below the set threshold.

1. Access the [Alarms] menu, using the procedure outlined on page 3-1.
2. Press the **software** keys to select [Voltage Alarm], then press the **function** key.
3. [Alarm] is highlighted, press the **function** key.
4. Select [OFF] or [ON] as appropriate, then press the **function** key.
 - [OFF]: Disable the alarm. Proceed to step 7.
 - [ON]: Enable the alarm.
5. Press the **software** keys to select the threshold, then press the **function** key.
6. Press the **software** keys to set the threshold as appropriate, then press the **function** key to apply the changes.
7. Press the **Menu/Back** key twice to close the menu.

3.7 Water Temperature Alarm





The water temperature alarm warns you when the temperature goes over or under the set threshold. The average temperature may also be used as a threshold and is calculated over one minute intervals.

1. Access the [Alarms] menu, using the procedure outlined on page 3-1.
2. Press the **software** keys to select [W Temp. Alarm], then press the **function** key.
3. [Alarm] is highlighted, press the **function** key.
4. Select [OFF], [Low], [High] or [Shear] as appropriate, then press the **function** key.
 - [OFF]: Disable the alarm. Proceed to step 7.
 - [Low]: Activates the alarm when the water temperature is lower than the set threshold.
 - [High]: Activates the alarm when the water temperature is higher than the set threshold.
 - [Shear]: Activates the alarm when the water temperature is higher than the set threshold for more than one minute.
5. Press the **software** keys to select the threshold, then press the **function** key.
6. Press the **software** keys to set the threshold as appropriate, then press the **function** key to apply the changes.
7. Press the **Menu/Back** key twice to close the menu.

3.8 Engine Alarms

The engine alarm is activated when the FI-70 receives information containing errors or alarms from the engine.

The indicators shown in the table below are normally displayed in gray when the engine category is selected. When an alarm is active, the corresponding indicator flashes and the color changes to an orange-red.

Indicator	Cause/location of problem
	Engine control system.
	Battery.
	Coolant.
	Oil pressure.

1. Access the [Alarms] menu, using the procedure outlined on page 3-1.
2. Press the **software** keys to select [Engine Alarm], then press the **function** key.
3. [Alarm] is highlighted, press the **function** key.
4. Select [OFF] or [ON] as appropriate, then press the **function** key.
 - [OFF]: Disable the alarm. Proceed to step 7.
 - [ON]: Enable the alarm.
5. Press the **software** keys to select the threshold, then press the **function** key.
6. Press the **software** keys to set the threshold as appropriate, then press the **function** key to apply the changes.
7. Press the **Menu/Back** key twice to close the menu.

3.9 Anchor Alarm

The anchor alarm activates when the vessel exceeds the selected distance from the point at which the alarm was set, or the depth is higher/lower than the depth threshold setting. This alarm is useful when at a standstill or not at the helm.

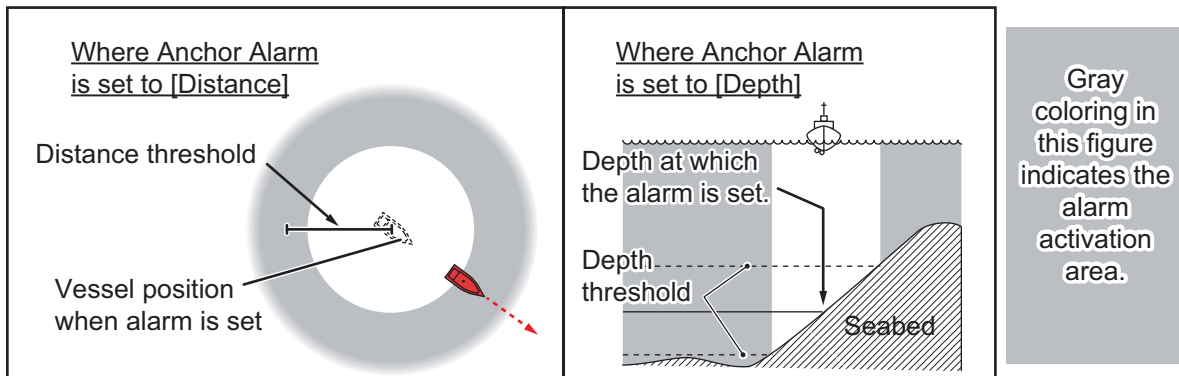

1. Access the [Alarms] menu, using the procedure outlined on page 3-1.
2. Press the **software** keys to select [Anchor Alarm], then press the **function** key.
3. [Alarm] is highlighted, press the **function** key.

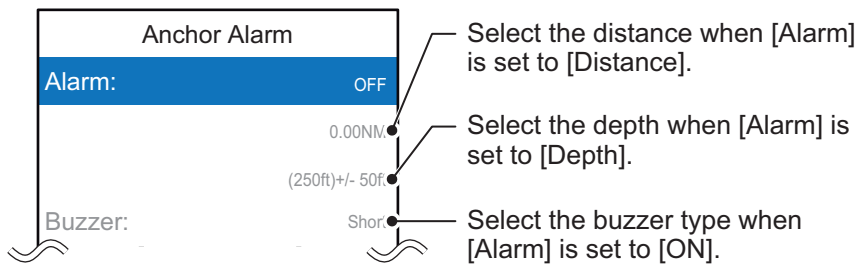

4. Select [OFF], [Distance] or [Depth] as appropriate, then press the **function** key.
 - [OFF]: Disable the alarm. Proceed to step 7.
 - [Distance]: Activates the alarm when the vessel goes over the distance threshold.
 - [Depth]: Activates the alarm when the vessel goes deeper or shallower than the depth threshold.
5. Press the **software** keys to select the threshold, then press the **function** key.
6. Press the **software** keys to set the threshold as appropriate, then press the **function** key to apply the changes.
7. Press the **Menu/Back** key twice to close the menu.

3.10 CPA/TCPA Alarms

The CPA (Closest Point of Approach) and TCPA (Time to Closest Point of Approach) alarms activate when the distance between your vessel and an AIS target is smaller than the threshold set. This alarm is used as an aid to avoid collision.

Note: The CPA and TCPA alarms are a navigational aid only. Do not rely solely on these indications, for safe boating.

1. Access the [Alarms] menu, using the procedure outlined on page 3-1.
2. Press the **software** keys to select [CPA/TCPA Alarm], then press the **function** key.
3. [Alarm] is highlighted, press the **function** key.
4. Select [OFF] or [ON] as appropriate, then press the **function** key.
 - [OFF]: Disable the alarm. Proceed to step 9.
 - [ON]: Enable the alarm.
5. Press the **software** keys to select [CPA], then press the **function** key.
6. Press the **software** keys to set the threshold as appropriate, then press the **function** key to apply the changes.
7. Press the **software** keys to select [TCPA], then press the **function** key.
8. Press the **software** keys to set the threshold as appropriate, then press the **function** key to apply the changes.
9. Press the **Menu/Back** key twice to close the menu.

3. ALARMS

This page is intentionally left blank.

4. SYSTEM MENU

This chapter explains the various items in the [System] menu which have not been explained yet. To open the [System] menu, do the following:

1. Press the **Menu/Back** key to display the main menu.
2. Press the **software** keys to select [System], then press the **function** key.

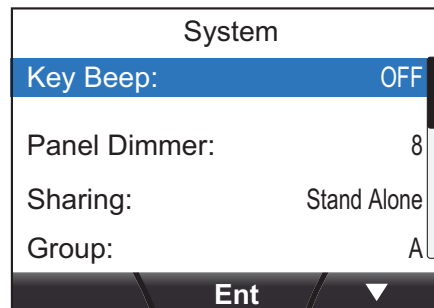

4.1 CAN bus (NMEA2000) Network Shared Settings

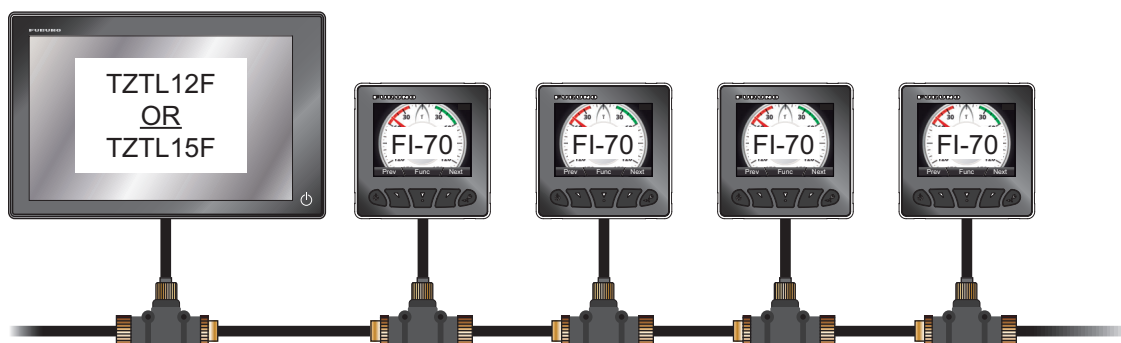

The NMEA network may contain one, or several, FI-70 units as well as other equipment. In the example above, the network contains a TZtouch2 unit and four FI-70 units.

Some settings, such as data source and offsets, made on a TZtouch2 unit (or FI-70 set as a Master unit) within the network may be passed onto the sub units on the same network. This requires adjustment of the [Sharing] setting on the FI-70 unit or units you wish to share settings with. The following list shows the settings which may be shared across the network.

- Display Format menu - [HDG/COG Ref], [Time Offset] and [Mag. Var. Value] only.
- Data Calibration menu - All settings, excluding [W Angle Response].
- Data Source menu - All settings, excluding tanks ([Tank1] to [Tank6]).
- Units menu - All settings.

Note: TZtouch2 units in the same network as the FI-70 are automatically assigned [Master] level sharing. In this situation, [Master] is not selectable from the [Sharing] menu.

4.1.1 How to adjust the sharing level

1. Access the System menu using the procedure outlined on page 4-1.
2. Press the **software** keys to scroll through the menu and select [Sharing], then press the **function** key.

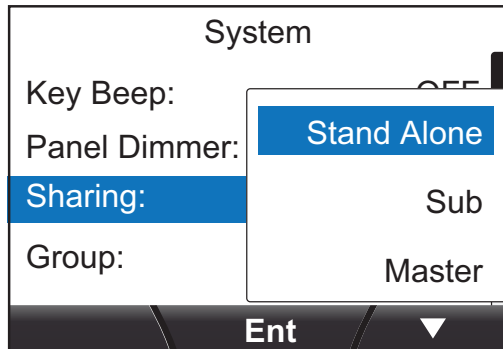

3. Press the **software** keys to select [Stand Alone], [Sub] or [Master], as appropriate, then press the **function** key to apply the setting.

Setting	Description
[Stand Alone]	Disables sharing of settings.
[Sub]	TZtouch2 unit (or FI-70 set as a Master unit) settings are passed to the FI-70 unit.
[Master]	This unit's settings are passed to all sub FI-70 units. Where a TZtouch2 unit is in the same network, the TZtouch2 unit is automatically assigned as the [Master] and this option is not available.

4. Press the **Menu/Back** key to close the menu.

4.2 How to Share Language and Brilliance Settings Between FI-70s

The [Language] and [Brilliance] settings may be shared within a group of FI-70s. If the settings are adjusted for one FI-70 unit in the group, all other FI-70 units are also adjusted, however, TZtouch2 unit settings are not adjusted.

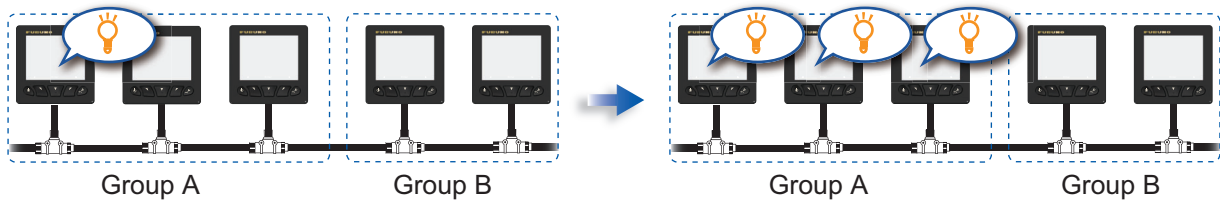

There are three groupings available: A, B and C. To assign a group to a FI-70 unit, do the following:

1. Access the [System] menu using the procedure outlined on page 4-1.
2. Press the **software** keys to scroll through the menu and select [Group], then press the **function** key.

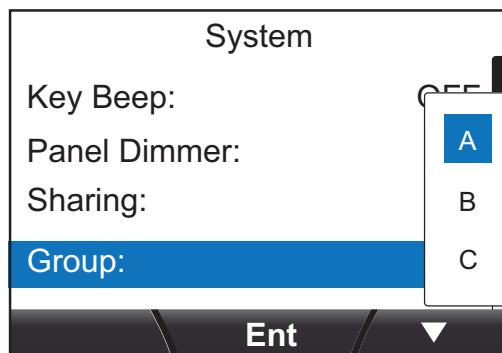

3. Press the **software** keys to select [A], [B] or [C], as appropriate, then press the **function** key to apply the setting.
4. Press the **Menu/Back** key to close the menu.

4.3 How to Set the Display Format

The format in which date, time and other displayed items are shown may be set from the [Display Format] menu. The [Display Format] is accessed from the [System] menu.

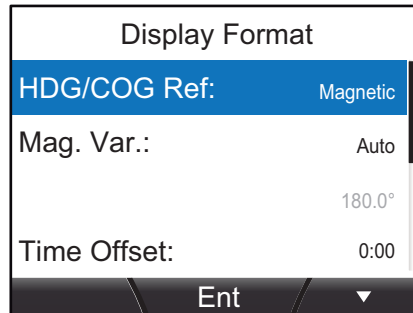

Menu option	Description	Available formats or setting range
[HDG/COG Ref]	Sets the format in which heading is displayed.	[Magnetic], [True]
[Mag. Var.]	Sets how to add magnetic variation (automatically or manually). This item is only available when [COG/HDG Ref] is set to [True]. When using a magnetic heading sensor, the magnetic variation is required to display a correct True heading. If there is an EPFS device connected to the same network, set this option to [Auto]. To set the variation manually, set this option to [Manual].	[Auto], [Manual] (setting range is W99.9° to E99.9°)
[Time Offset]	Sets the UTC time offset.	[-14:00] to [+14:00]
[Time Display]	Sets the format in which the time is displayed.	[12Hour], [24Hour]
[Date Display]	Sets the format in which the date is displayed. D = Day, M = Month, Y = Year	[MMM DD, YYYY], [DD MMM YYYY], [YYYY MM DD]
[Position Format]	Sets the format in which position coordinates are displayed.	[DD°MM.MM'], [DD°MM.MMM'], [DD°MM.MMMM'], [DD°MM'SS.S]

4.4 How to Adjust the Engine Settings

The number of engines aboard the vessel and which engine number is used as a display data source are set from the [Engine Setup] menu.

Note: The following settings must be completed in order to display correct engine data on the FI-70.

1. Access the [System] menu using the procedure outlined on page 4-1.
2. Press the **software** keys to select [Engine Setup], then press the **function** key.
3. Press the **software** keys to select [Number of Engine], then press the **function** key.
4. Press the **software** keys to select the appropriate number of engines aboard the vessel, then press the **function** key.

The FI-70 is able to display up to three engines' data. The [Number of Engine] setting also changes the [Engine Setup] menu layout, as shown in the figure below.

<u>One engine</u>	<u>Two engines</u>	<u>Three engines</u>
Engine	Engine	Engine
Engine Assign: 1	Engine PORT: 1	Engine PORT: 1
Engine Alarm	Engine STBD: 2	Engine STBD: 2
	Engine Alarm	Engine Center: 3
		Engine Alarm
Ent	Ent	Ent

5. Select the engine number to be used as the data source.

Note: Engine number assignment must be done at the engine.

Where [Number of Engine] is set to [1]

[Engine Assign]: Select the engine to use as the data source.

Where [Number of Engine] is set to [2]

[Engine PORT]: Select the engine to use as the port-side data source.

[Engine STBD]: Select the engine to use as the starboard-side data source.

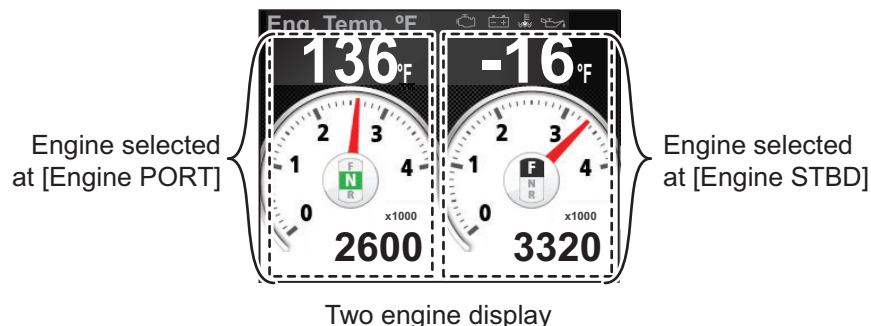

4. SYSTEM MENU

Where [Number of Engine] is set to [3]

[Engine PORT]: Select the engine to use as the port-side data source.

[Engine STBD]: Select the engine to use as the starboard-side data source.

[Engine Center]: Select the engine to use as the center data source.

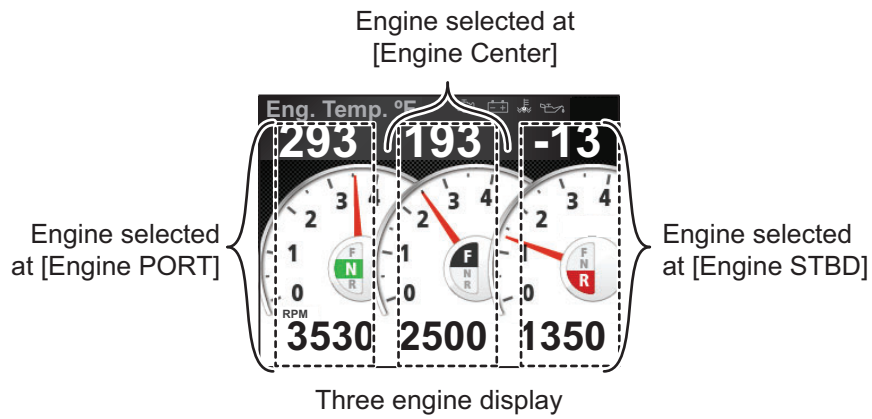

6. Press the **Menu/Back** key twice to close the menu.

How to update the engine list [Engine Refresh]

When an engine is removed for service, or when the FI-70 otherwise loses connection with the engines, it is important to update the engine list. The [Engine Refresh] function checks the CAN bus/NMEA2000 network for connected engines and updates the engine list.

4.5 How to Set the Displayed Scale Range

The displayed range for speed, engine and custom box meters may be adjusted by following the procedure below.

1. Access the [System] menu using the procedure outlined on page 4-1.
2. Press the **software** keys to select [Scale Range], then press the **function** key.

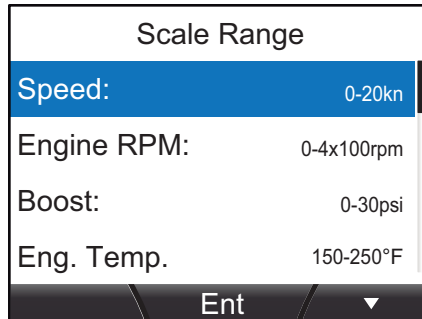

3. Press the **software** keys to select the scale range you wish to adjust.

Note: The table below lists the available options based on default unit of measurement settings. Options available on your FI-70 unit may be different.

Menu Item	Description/Setting Options
[Speed]	Adjust the displayable speed range. Options: 0-20kn, 0-40kn, 0-80kn.
[Engine RPM]	Adjust the displayable RPM range. Options: 0-4×1000rpm, 0-6×1000rpm, 0-8×1000rpm.
[Boost]	Adjust the displayable boost range. Options: 0-30psi, 0-70psi, 0-150psi, 0-360psi.
[Eng. Temp.]	Adjust the displayable engine temperature range. Options: 150-250°F, 120-300°F.
[Oil Press.]	Adjust the displayable oil pressure range. Options: 0-30psi, 0-70psi, 0-150psi, 0-360psi, 0-440psi.
[Oil Temp.]	Adjust the displayable oil temperature range. Options: 150-250°F, 120-300°F.
[Coolant P]	Adjust the displayable coolant pressure range. Options: 0-30psi, 0-70psi, 0-150psi, 0-360psi, 0-440psi.
[Gear Oil P]	Adjust the displayable gear oil pressure range. Options: 0-30psi, 0-70psi, 0-150psi, 0-360psi, 0-440psi.
[Gear Oil T]	Adjust the displayable gear oil temperature range. Options: 150-250°F, 120-300°F.
[Voltage]	Adjust the displayable voltage range. Options: 8-16V, 16-32V.

4. Press the **software** keys to select the appropriate option, then press the **function** key.
5. Press the **Menu/Back** key twice to close the menu.

4.6 How to Set Up the IF-NMEAFI (Option)

The optional IF-NMEAFI is required when inputting data from analog NMEA equipment to the FI-70. Set the IF-NMEAFI up as follows.

4.6.1 IF-NMEAFI menu settings

1. Access the [System] menu using the procedure outlined on page 4-1.
2. Press the **software** keys to select [IF-NMEAFI], then press the **function** key.

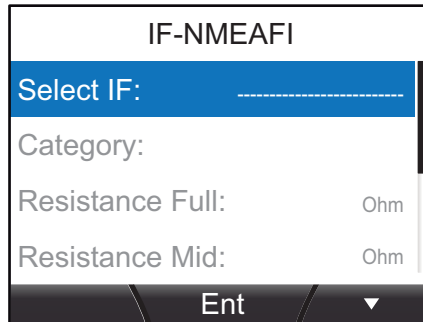

3. [Select IF] is already selected, press the **function** key. A pop-up window similar to the one shown on the right is displayed.
4. Press the **software** keys to select the appropriate IF-NMEAFI unit, then press the **function** key.

Select IF:

IF-NMEAF :000007
IF-NMEAF :000008
5. Press the **software** keys to select [Category], then press the **function** key.
6. Press the **software** keys to select the category for the connected analog sensor, then press the **function** key. The available options are listed below, with a brief explanation.
 - [Wind]: For wind sensor connection (FI-5001/L).
 - [ST800/ST850]: For water temperature/speed sensor connection (ST-02PSB/ST-02MSB)
 - [Fuel]: For fuel tank gauge connection.
 - [Fresh Water]: For fresh water tank gauge connection.
 - [Waste Water]: For waste water tank gauge connection.
 - [Live Well]: For live well tank gauge connection.
 - [Oil]: For oil tank gauge connection.
 - [Black Water]: For black water tank gauge connection.
7. If the selection at step 6 is neither [Wind] nor [ST800/ST850], the following four menu items must also be set.
 - [Resistance Full]: The resistance, in Ohms, when the tank is full.
 - [Resistance Mid]: The resistance, in Ohms, when the tank is half full.
 - [Resistance Empty]: The resistance, in Ohms, when the tank is empty.
 - [Capacity]: The capacity of the tank.
8. Press the **Menu/Back** key twice to lose the menu.

4.6.2 How to test the IF-NMEAFI

1. Access the [System] menu using the procedure outlined on page 4-1.
2. Press the **software** keys to select [IF-NMEAFI], then press the **function** key.
3. [Select IF] is already selected, press the **function** key.
4. Press the **software** keys to select the appropriate IF-NMEAFI unit, then press the **function** key.
5. Press the **software** keys to select [IF-NMEAFI Test], then press the **function** key. The diagnostic results screen for the selected IF-NMEAFI unit is displayed.

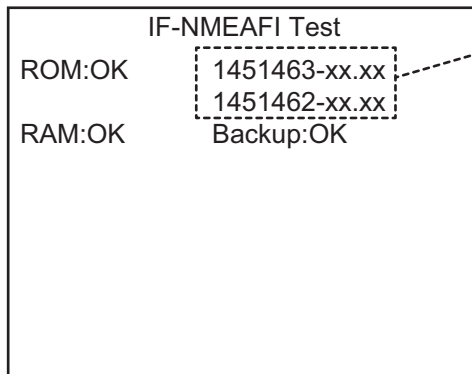

ROM Program numbers. "xx" denotes version number.

ROM: Result displayed as OK or NG (No Good)
RAM: Result displayed as OK or NG (No Good)
Backup: Result displayed as OK or NG (No Good)

6. Press the **Menu/Back** key at any time to close the results screen.
7. Press the **Menu/Back** key twice to close the menu.

4.6.3 How to reset the IF-NMEAFI to factory default settings

1. Access the [System] menu using the procedure outlined on page 4-1.
2. Press the **software** keys to select [IF-NMEAFI], then press the **function** key.
3. [Select IF] is already selected, press the **function** key.
4. Press the **software** keys to select the appropriate IF-NMEAFI unit, then press the **function** key.
5. Press the **software** keys to select [Refresh], then press the **function** key. The confirmation pop-up window shown to the right is displayed.
6. To abandon the reset, press the right **software** key. Press the left **software** key to reset the factory default settings. The IF-NMEAFI will now restart, restoring all factory settings and the message shown to the above right appears.
7. Press the **Menu/Back** key twice to close the menu.

Refresh IF-NMEAFI setting.
Are you sure?

Please wait a moment.

4.7 How to Setup the SC-30

You can setup a SATELLITE COMPASS™ SC-30 from the [SC-30 Setup] menu. The SC-30 must be connected to the same network as this FI-70.

1. Access the [System] menu using the procedure outlined on page 4-1.
2. Press the **software** keys to select [SC-30 Setup], then press the **function** key.

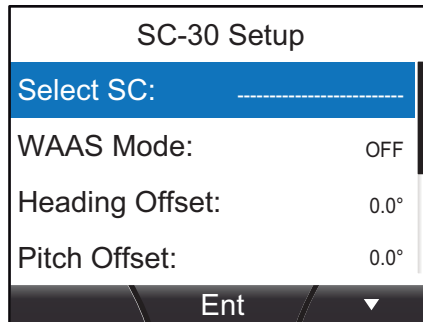

3. [Select SC] is already selected, press the **function** key.
4. Press the **software** keys to select the appropriate SC-30 unit, then press the **function** key.
5. Press the **software** keys to select [WAAS Mode], then press the **function** key.
6. To use the SC-30 WAAS mode, select [ON], then press the **function** key.
7. Press the **software** keys to select the appropriate data to offset, then press the **function** key.

Menu item	Description
[Heading Offset]	Offset the heading value.
[Pitch Offset]	Offset the pitch value.
[Roll Offset]	Offset the roll value.

8. Press the **software** keys to select the required offset setting, then press the **function** key.
9. Press the **Menu/Back** key twice to close the menu.

4.8 How to Interpret the I/O Setup Menu

The [I/O Setup] menu contains information regarding incoming data. This menu is accessed from the [System] menu.

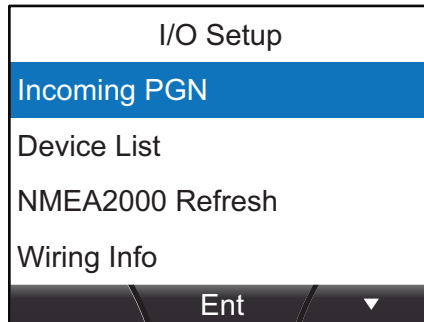

[Incoming PGN]

Select [Incoming PGN] to display a list of PGNs which may be input to this FI-70 unit. Items in the PGN list which are available are shown in black, unavailable items are shown in gray.

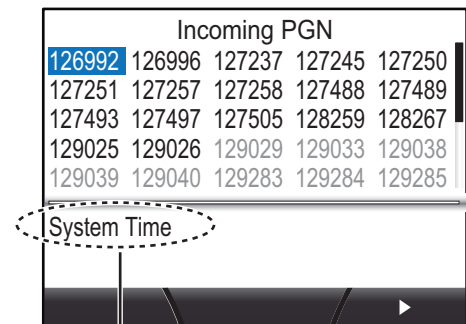

Currently selected PGN's name

[Device List]

Select [Device List] to display a list of devices connected to the same network as this FI-70 unit. The list shows the device name and the device's unique network identification number.

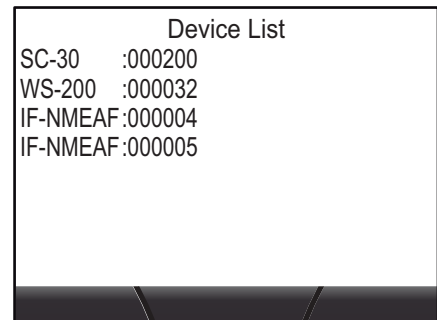

[NMEA2000 Refresh]

Select [NMEA2000 Refresh] to refresh the items displayed in the [Incoming PGN] and [Device List] screens. The lists should be refreshed when devices are added or removed from the same network as this FI-70 unit.

[Wiring Info]

Select [Wiring Info] to display the NMEA2000 connector's wiring signals and wire colors.

4.9 How to Set the Data Source(s)

The FI-70 automatically detects and connects to data sources within the network. These settings can be changed as required by doing the following:

1. Access the [System] menu using the procedure outlined on page 4-1.
2. Press the **software** keys to select [Data Source], then press the **function** key.

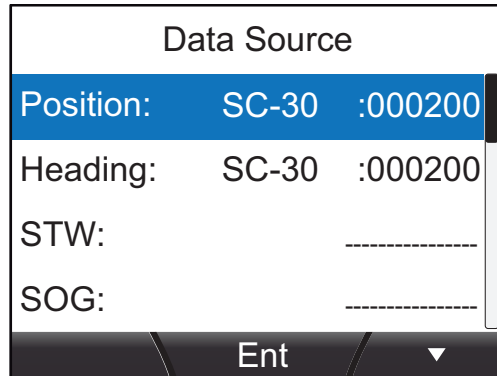

3. Press the **software** keys to select the appropriate source, then press the **function** key.

Source	Description
[Position]	Data source for position related information (GPS, etc.)
[Heading]	Data source for heading related information
[STW]	Data source for Speed Through Water
[SOG]	Data source for Speed Over Ground
[Navigation]	Data source for navigation
[Depth]	Data source for depth
[Water Temp.]	Data source for water temperature
[Wind]	Data source for wind angle/speed
[AIS]	Data source for AIS related information
[Tank1] thru [Tank6]	Data source for tank related information

4. Press the **software** keys to select the appropriate sensor, then press the **function** key.
5. Repeat the procedure to adjust other sensor's settings as necessary.
6. Press the **Menu/Back** key twice to close the menu.

Automatic data source switching

The FI-70 can automatically switch data sources if data from the set source is interrupted or lost, provided there is a suitable sensor connected to the same network as the FI-70.

AIS and all tank sensors are not switched automatically.

4.10 How to Adjust (Calibrate) Incoming Data

Use the [Data Calibration] menu to adjust offsets for data input to the FI-70.

1. Access the [System] menu using the procedure outlined on page 4-1.
2. Press the **software** keys to select [Data Calibration], then press the **function** key.

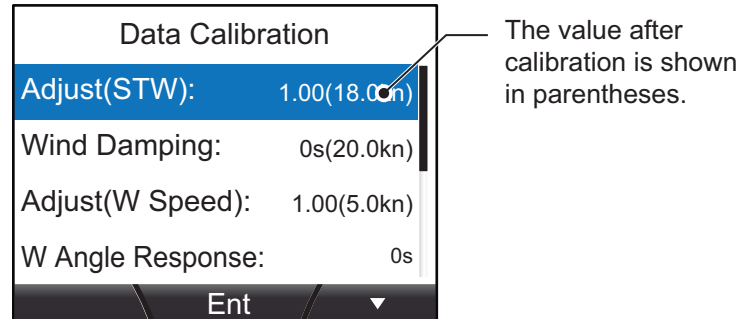

3. Press the **software** keys to select the appropriate data to offset, then press the **function** key.

The data which can be offset is shown in table below.

Adjust (STW)	Offset the speed displayed.
Wind Damping	Offset the delay between wind sensor and FI-70.
Adjust (W Speed)	Offset the wind speed displayed.
W Angle Response	Sets the needle response speed. Lower settings give a faster response (needle movement).
Offset (W Angle)	Offset the wind angle.
Offset (HDG)	Offset the heading.
Offset (Depth)	Offset the depth.
Offset (W Temp.	Offset the water temperature.

4. Press the **software** keys to select the required offset, then press the **function** key.
5. Press the **Menu/Back** key twice to close the menu.

4.11 How to Change the Language

To change the language, do the following:

1. Access the [System] menu using the procedure outlined on page 4-1.
2. Press the **software** keys select [Language], then press the **function** key.
3. Press the **software** keys to select the appropriate language, then press the **function** key to apply the setting.
4. Press the **Menu/Back** key to close the menu.

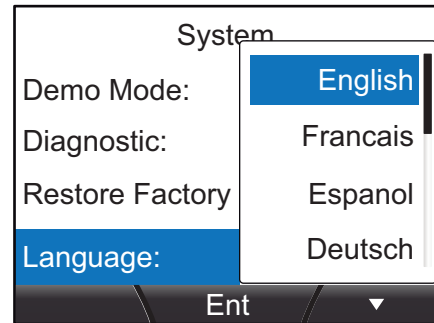

4.12 How to Change the Units of Measurement

All units of measurement display may be changed using the procedure below.

1. Access the [System] menu using the procedure outlined on page 4-1.
2. Press the **software** keys select [Units], then press the **function** key.
3. Select the appropriate unit to adjust, then press the **function** key to display the available options.
4. Adjust the units as required, then press the **function** key.
5. Press the **Menu/Back** key twice to close the menus.

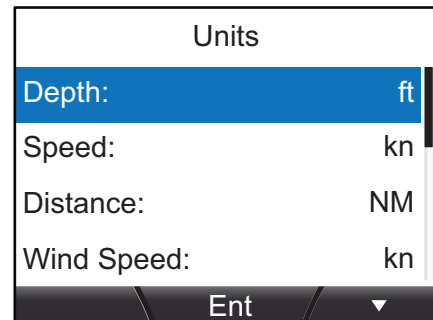

The units and their available options are shown in the table below.

Unit	Available options
[Depth]	[ft], [m], [fm], [PB]
[Speed]	[kn], [km/h], [MPH]
[Distance]	[NM], [km], [SM], [NM,yd]*, [NM,m]*, [km,m]*, [SM,yd]*
[Wind Speed]	[kn], [km/h], [MPH], [m/s]
[Temp.] (Temperature)	[°C], [°F]
[Fluid]	[l], [gal]
[Atmos. Press.] (Atmospheric Pressure)	[hPa], [mbar]
[Engine Press.] (Engine Pressure)	[kPa], [bar], [psi]

*: The FI-70 can not display the trip and odometer by the meter and yard. For example, when [Distance] is set to [NM,yd], this equipment displays the trip and odometer only by the nautical mile.

4.13 Other Items

Demo Mode

The [Demo Mode] is a demonstration of the various displays and categories available to the FI-70. It uses pre-loaded information on a cycle, simulating regular use. [Demo Mode] does not require sensor connection.

When the [Demo Mode] is active, the  indicator is constantly shown at the top right of the display, regardless of category, menu or settings. Pages are automatically changed at regular intervals during this mode.

Note: Do not use this mode when the vessel is underway.

Diagnostic

The [Diagnostic] menu may be used to conduct a self-test of FI-70, test the keys or test the screen.

For more information on the [Diagnostic] menu, see "How to Diagnostically Test the FI-70" on page 6-5.

Restore Factory Default

Resets the FI-70 to its original factory settings.

Note: This action removes all user settings and adjustments.

4. SYSTEM MENU

This page is intentionally left blank.

5. INSTALLATION AND INITIAL SETTINGS

5.1 How to Mount the FI-70

Mounting guidelines

Follow these guidelines when selecting a mounting location.

- Select a well ventilated location.
- Select a location with minimal vibration and shock.
- Keep the FI-70 away from heat sources such as vents and exhausts.
- Observe the compass safe distances, as outlined at the start of this manual.
- Select a flat location with less than 1 mm difference in height.
- Consider the connecting cable length when selecting the mounting location.
- Referring to the outline drawing at the back of this manual, leave sufficient space around the FI-70 to allow for service and maintenance.
- When the FI-70 is not in use, fit the soft cover (supplied) to the FI-70. Leave sufficient room surrounding the FI-70 to allow fitting of the soft cover.
- Where the rear connectors and CAN bus/NMEA2000 connectors are subjected to moisture or water spray, waterproof the connectors as shown below.
 1. Wrap the connection point with a single layer of vinyl tape.
 2. Wrap one layer of self-bonding tape over the vinyl tape.
 3. Wrap two layers of vinyl tape over the self-bonding tape.

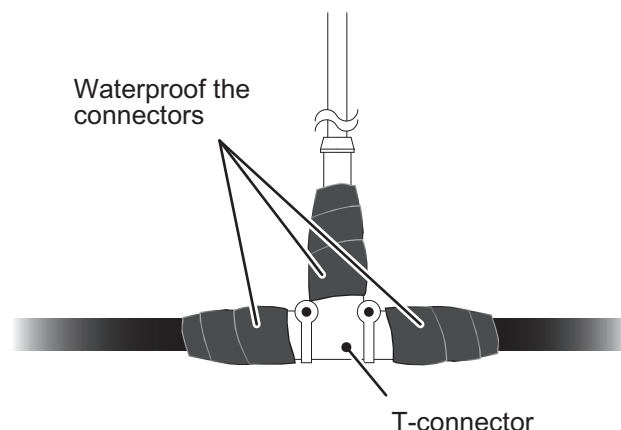

5.1.1 Flushmount

Using the figure below for reference, follow the procedure to flush mount the FI-70.

Note: When retrofitting from a FI-50 series instrument, re-drill the stud bolt holes where the FI-50 series instrument was installed to allow use of the mounting hole.

1. Using the supplied template, cut a hole in the mounting location.
2. Fit the stud bolts (M3×40, 2 pcs, supplied) to the rear of the FI-70.

Note: Do not use tools to fit or insert the stud bolts.

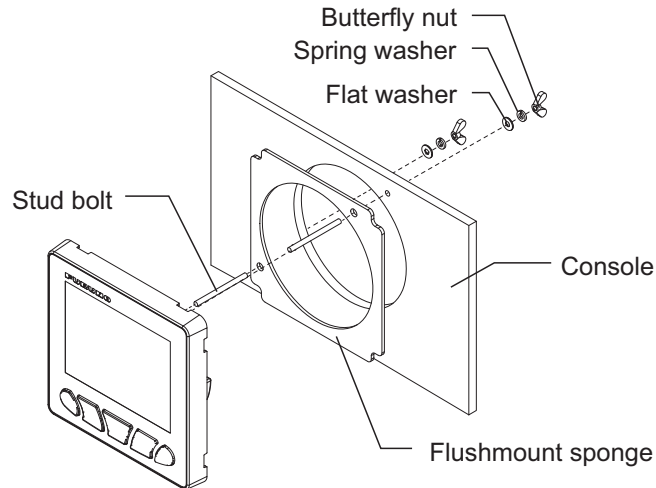

3. Fit the flushmount sponge (supplied) to the rear of the FI-70.
4. Feed the cable through the cutout, then fit the cable to the FI-70.
5. Set the FI-70 into the mounting hole, making sure the FI-70 is oriented upwards.
6. Fit and tighten the washers and butterfly nut (washers and butterfly nut supplied).

When using locally supplied materials

When using locally supplied screws to secure the FI-70, the thread depth should be approx. 5 mm, as indicated in the figure below.

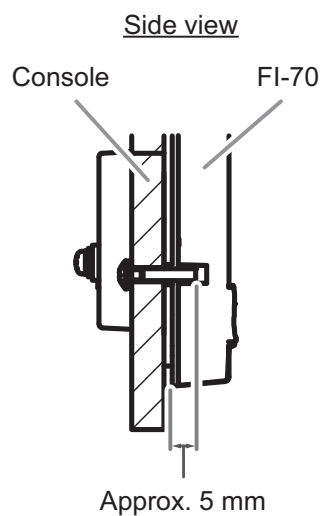

5.1.2 Frontmount (Option)

The optional frontmount kit may be used to install the FI-70 where access behind the console is limited.

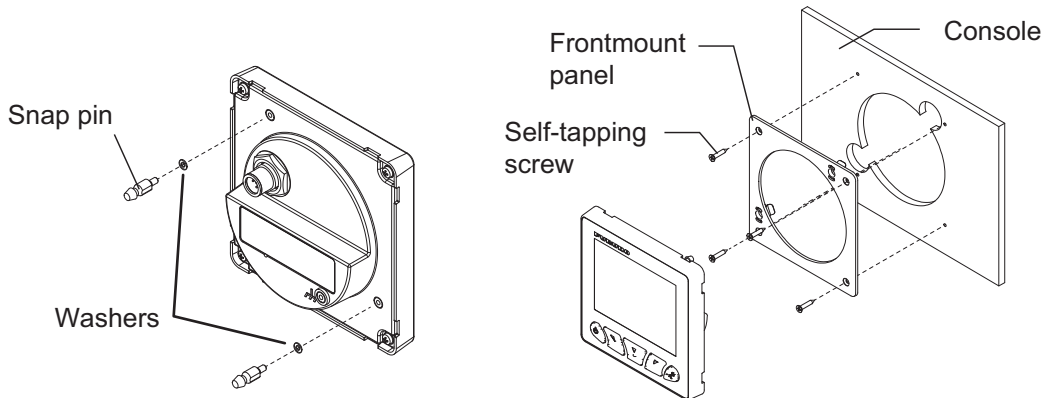

1. Using the template supplied with the frontmount kit, cut a hole in the mounting location.

2. Fit the snap pins and washers (supplied in the frontmount kit) to the FI-70, as shown in the figure above.

3. Fit the frontmount panel to the console with four self-tapping screws (supplied in the frontmount kit).

Note: Check that the frontmount panel is oriented in the correct manner, referring to the figure on the right.

4. Feed the cable through the cutout, then fit the cable to the FI-70.

5. Set the FI-70 into the frontmount panel, using the snap pins and snap pin slots as guides.

6. Push the FI-70 into the frontmount panel until a “click” sound is made, indicating that the FI-70 is now secure in the panel.

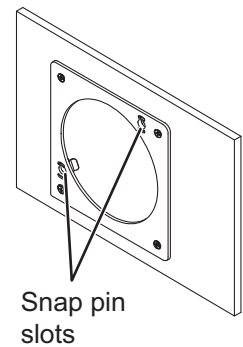

How to waterproof the mounting holes

Where there is a risk of water seepage around the frontmount hole, the hole must be waterproofed using marine sealant. Care must be taken not to fill the soft cover locking points on the FI-70. (Eight in total, four at the top rear of the unit and four at the bottom rear of the unit, see the figure below for reference.) Silicone seepage into the locking points prevents the soft cover from fitting correctly.

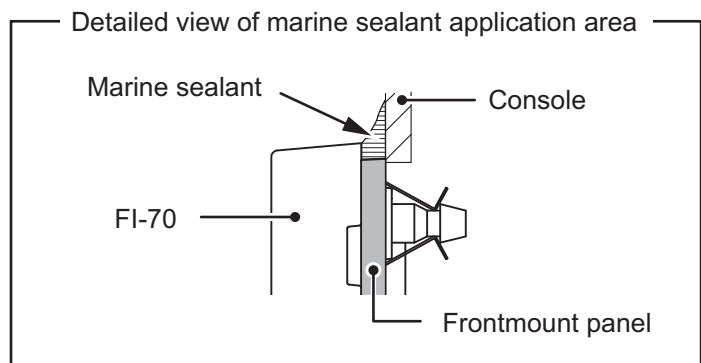
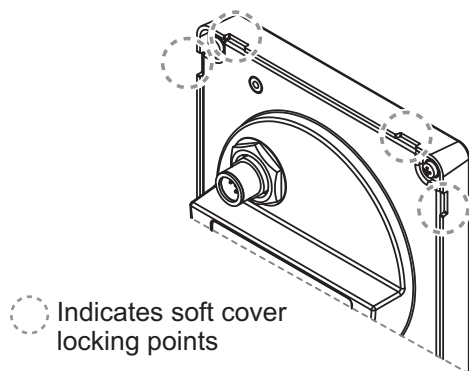

5. INSTALLATION AND INITIAL SETTINGS

How to remove a frontmounted FI-70

To remove the FI-70 from the frontmount panel, release the pin holders at the back of the panel, then remove the FI-70. Forced removal may damage the pin holders, pins, frontmount panel or the FI-70 unit.

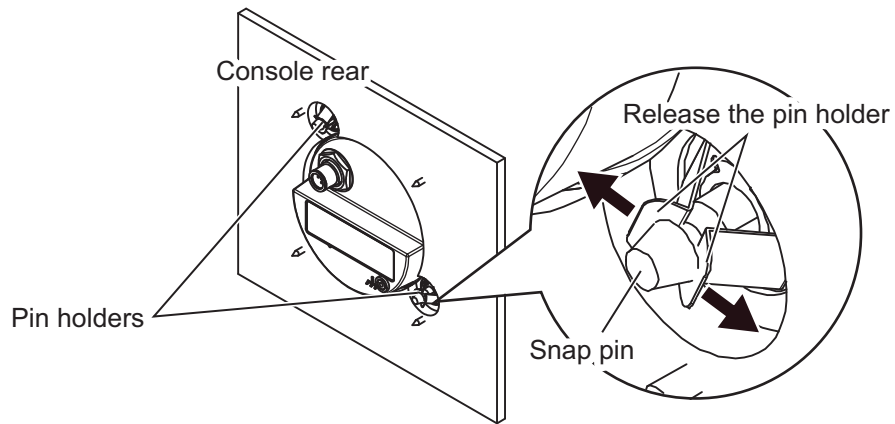

5.2 Wiring

The FI-70 is able to display information from various sensors. The typical configuration example shown in "SYSTEM CONFIGURATION" on page vi uses the optional data converter (IF-NMEAFI) to show information from the analog sensors. The FI-70 is part of a network, connected via a CAN bus/NMEA2000 backbone.

Note: Unlike the FI-50 series, the FI-70 can not be daisy-chained. When retrofitting from the FI-50 series, connect each FI-70 to the CAN bus (NMEA2000) backbone.

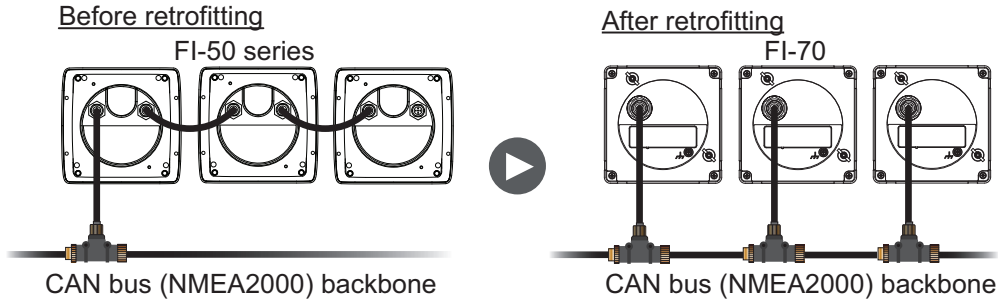

5.2.1 How to connect the unit

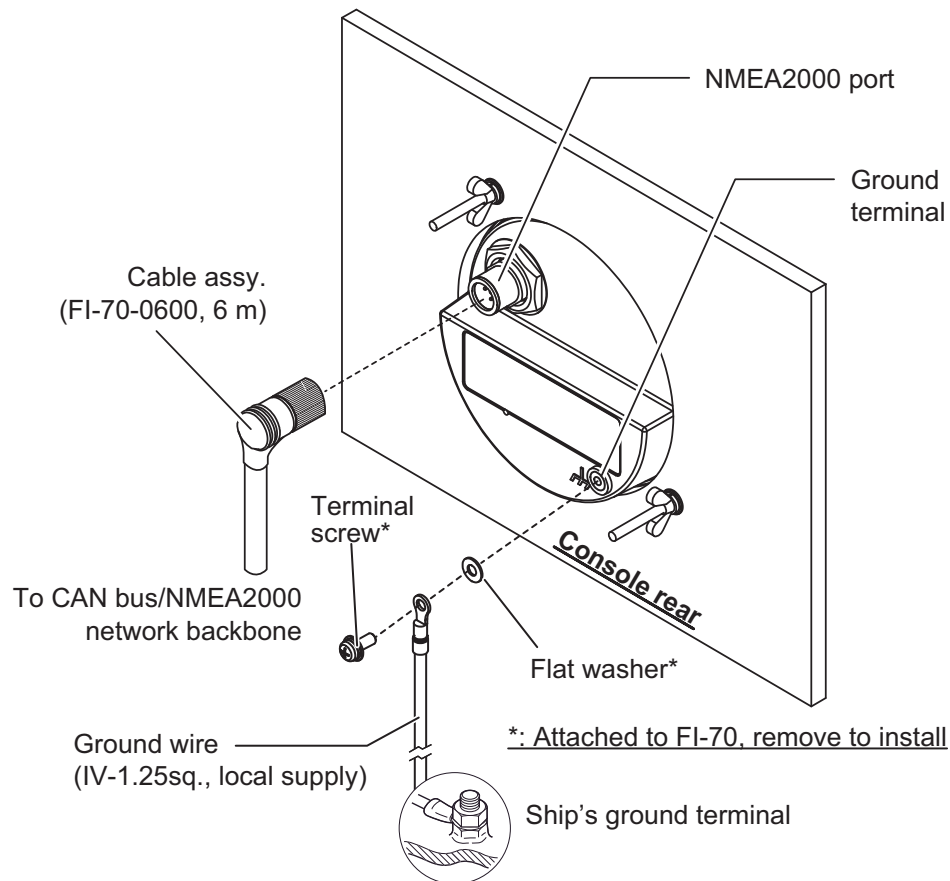

NMEA2000 port

Using the supplied cable assembly, connect the FI-70 to the CAN bus/NMEA2000 network backbone. The FI-70 must be on the same network as the sensors you wish to connect to. Power is also supplied via the CAN bus/NMEA2000 backbone to the FI-70.

What is CAN bus?

CAN bus is a communication protocol (NMEA2000 compliant) that shares multiple data and signals through a single backbone cable. You can simply connect any CAN bus devices onto the backbone cable to expand your network on-board. With CAN bus, IDs are assigned to all the devices in the network, and the status of each sensor in the network can be detected. All the CAN bus devices can be incorporated into the CAN bus network. For detailed information about CAN bus wiring, see “Furuno CAN bus Network Design Guide” (Type: TIE-00170) on Tech-Net.

How to ground the FI-70

1. Fabricate a grounding cable (IV-1.25sq., local supply) with a close-end terminator (local supply).
2. Connect the close-end terminator to the rear of the FI-70, as indicated in the figure on the previous page.
3. Connect the loose end of the grounding cable to the ship’s ground.

5.2.2 How to connect to the Wind Transducers FI-5001/L

The IF-NMEAFI Analog Data Converter is required when connecting the Wind Transducer FI-5001 or FI-5001L, in order to convert the analog data from the sensor to CAN bus/NMEA2000 format data. When connecting the FI-70 to the FI-5001 or FI-5001L, use the terminal box included with the FI-5001 or FI-5001L.

For details on installation of the IF-NMEAFI and FI-5001 or FI-5001L, refer to the Installation Manual (IMC-72661) or Installation Guide (C72-01403).

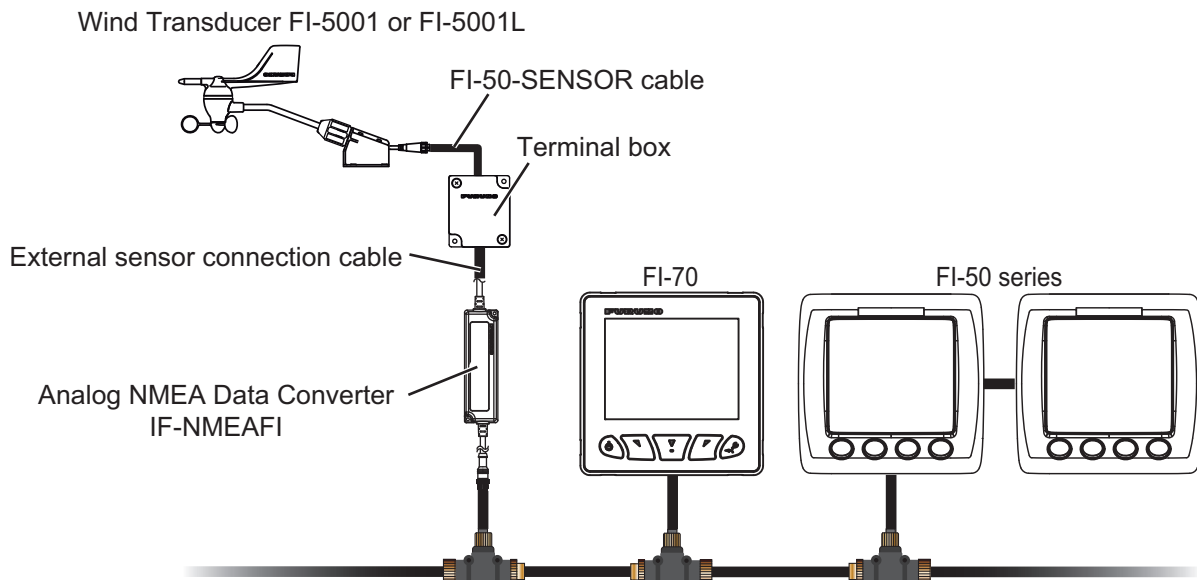

Note: If the FI-50 series use the wind transducer’s data converted by the analog NMEA data converter, change the setting for wind data selection on the Setup1 menu. For how to change the setting, see the Operator’s Manual of the FI-50 series.

1. Referring to the figures below, fabricate the external sensor connection cable and FI-50-SENSOR cable.

FI-50-SENSOR cable (FI-5001/L)

Cut off the connector to fabricate the cable.

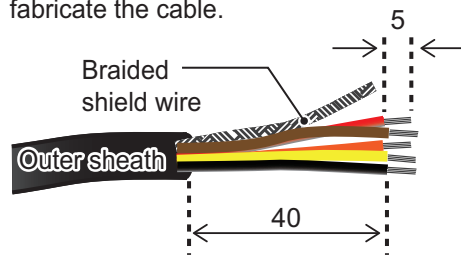

External sensor connection cable (IF-NMEAFI)

Cut unused wires to a suitable length, then isolate them with vinyl tape.

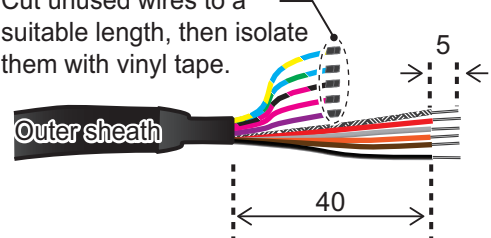

Dimensions shown in millimeters (mm).

2. Unfasten the two screws on the terminal box cover, remove the cover and connect the wires to the their respective terminal block.

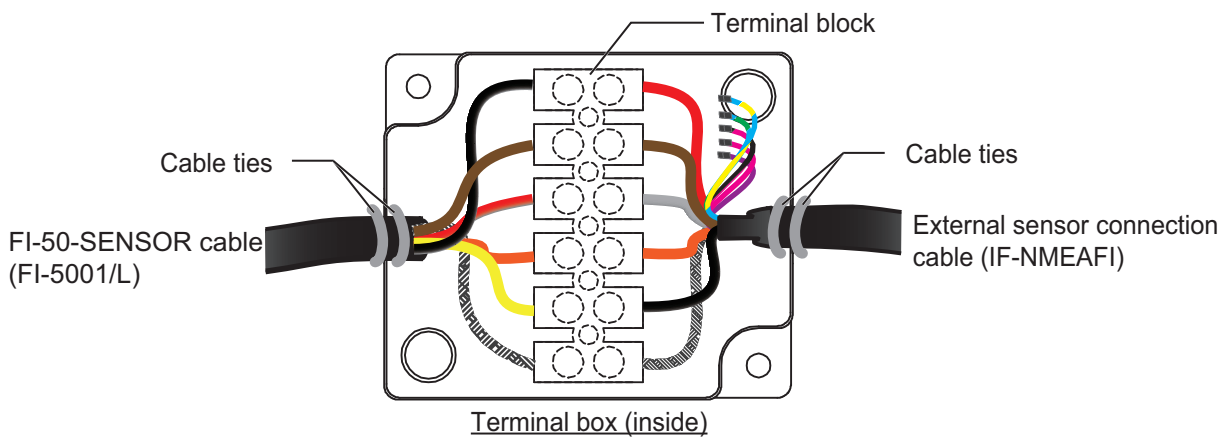

3. Secure the cables to the terminal box with cable ties (included with FI-5001/L).
4. Close the cover of the terminal box.

5.2.3 How to connect to the FI-5002 Junction Box (Option)

When using the FI-5002, connect the NMEA2000 port of the FI-70 to the FI-5002 internal MC connectors (CN3 thru CN5).

For FI-5002 installation instructions, refer to the Installation Manual (C72-00702).

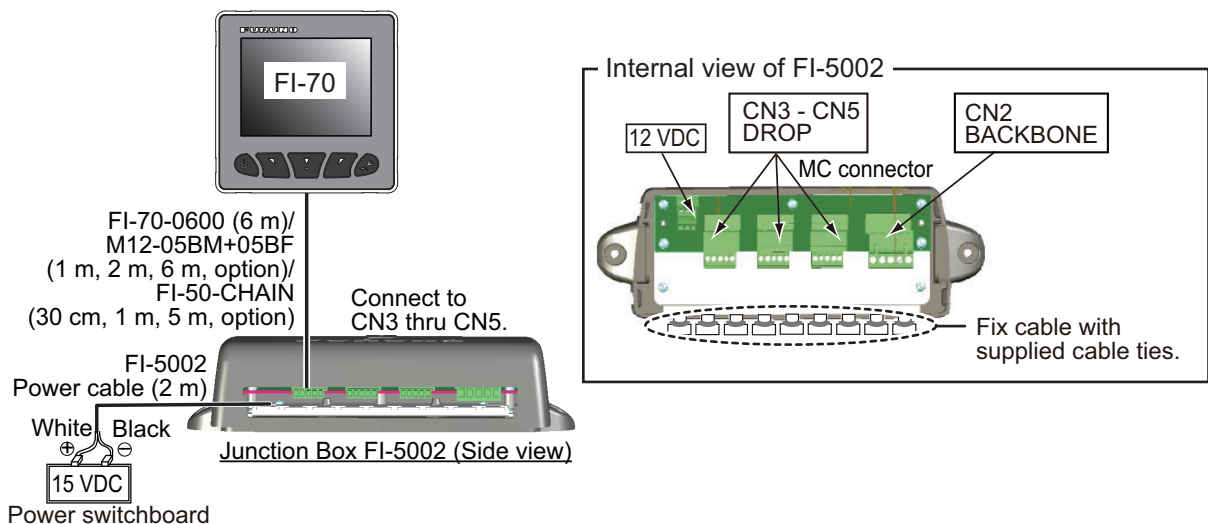

5. INSTALLATION AND INITIAL SETTINGS

How to fabricate the cable and MC connector

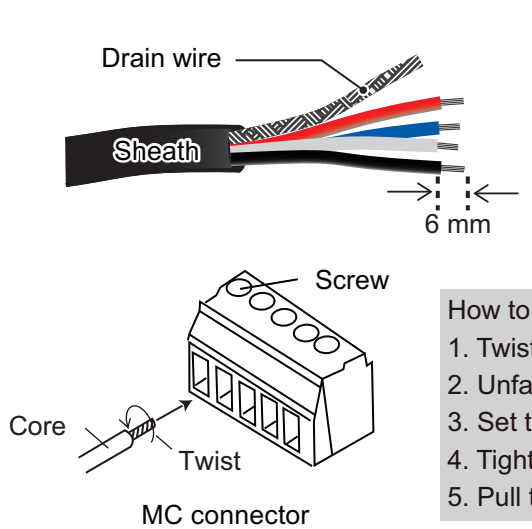

Wire	Signal	Connection Point
Drain	SHIELD	1
Red	NET-S	2
Black	NET-C	3
White	NET-H	4
Blue	NET-L	5

How to insert cores:

1. Twist the cores.
2. Unfasten the screw with Philips head screwdriver.
3. Set the core to hole.
4. Tighten the screw.
5. Pull the wire to confirm connection.

5.2.4 Terminator resistors

Terminator resistors are required to close off the network ends, completing the network.

The following FURUNO terminator resistors are available:

Part name	Type	Code No.	Remarks
NMEA Connector	LTWMN-05AMMT-SL8001	000-160-508-10	Mini connector, male
	LTWMN-05AFFT-SL8001	000-160-509-10	Mini connector, female
	LTWMC-05BMMT-SL8001	000-168-604-10	Micro connector, male
	LTWMC-05BFFT-SL8001	000-168-605-10	Micro connector, female

Direct connection to the CAN bus/NMEA2000 backbone

Install terminator resistors to both ends of the CAN bus/NMEA2000 network backbone cable.

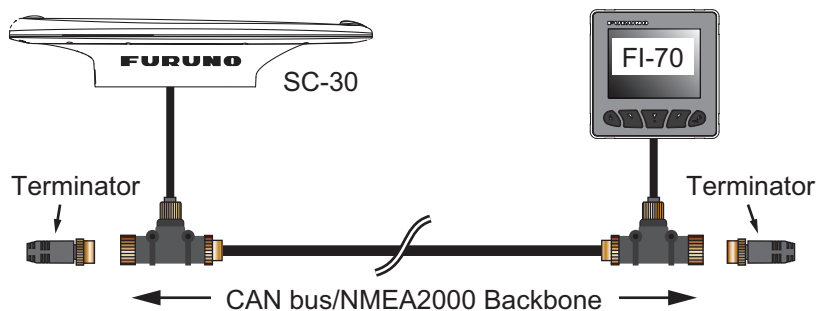

Connection via the FI-5002 junction box (option)

The FI-5002 has two terminal resistors (R1 and R2). The resistors are set in the following manner:

- When no backbone cable is connected, R1 and R2 are set to ON position.
- When one backbone cable is connected, either R1 or R2 is set to ON position.
- When two backbone cables are connected, R1 and R2 are set to OFF position.

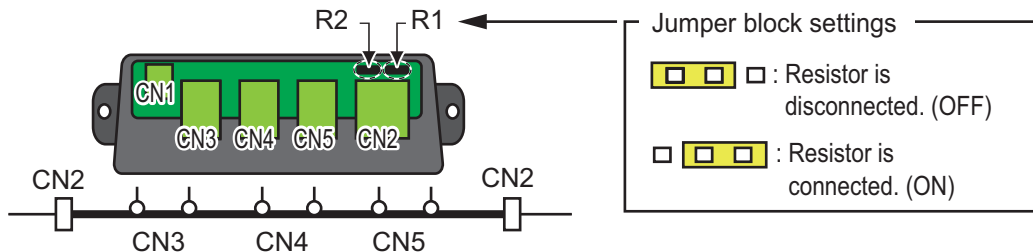

5.3 Input/Output PGNs

The FI-70 can input/output the following PGNs.

Input PGNs

PGN	Description	PGN	Description
059904	ISO Request	060928	ISO Address Claim
061184	Self Test Group Function	126208	NMEA - Request/Acknowledge Group Function
126720	Memory Group Function/Request Group Function/GMM Message	126992	System Time
126996	Product Information	127237	Heading/Track Control
127245	Rudder	127250	Vessel Heading
127251	Rate of Turn	127257	Attitude
127258	Magnetic Variation	127488	Engine Parameters, Rapid Update
127489	Engine Parameters, Dynamic	127493	Transmission Parameters, Dynamic
127497	Trip Parameters, Engine	127505	Fluid Level
128259	Speed, Water Referenced	128267	Water Depth
129025	Position, Rapid Update	129026	COG & SOG, Rapid Update
129029	GNSS Position Data	129033	Local Time Offset
129038	AIS Class A Position Report	129039	AIS Class B Position Report
129040	AIS Class B Extended Position Report	129283	Cross Track Error
129284	Navigation Data	129285	Navigation - Route/WP Information
129538	GNSS Control Status	129794	AIS Class A Static and Voyage Related Data
129809	AIS Class B "CS" Static Data Report, Part A	129810	AIS Class B "CS" Static Data Report, Part B
130306	Wind Data	130310	Environmental Parameters
130311	Environmental Parameters	130312	Temperature
130313	Humidity	130314	Actual Pressure
130316	Temperature, Extended Range	130576	Trim Tab Status
130577	Direction Data	130816	Proprietary PGN (Furuno)
130818	Proprietary PGN (Furuno)	130821	Proprietary PGN (Furuno)
130822	Proprietary PGN (Furuno)	130825	Proprietary PGN (Furuno)

PGN	Description	PGN	Description
130880	Proprietary PGN (Furuno)	130841	Proprietary PGN (Furuno)
65280	Honda Engine Status Parameter		

Output PGNs

PGN	Description	PGN	Description
059392	ISO Acknowledgment	059904	ISO Request
060928	ISO Address Claim	061184	Self Test Group Function
126208	NMEA - Request/Acknowledge Group Function	126464	Receive/Transmit PGN's Group Function
126720	Memory Group Function/Request Group Function/GMM Message	126993	Heartbeat
126996	Product Information	130314	Actual Pressure
130816	Proprietary PGN (Furuno)	130821	Proprietary PGN (Furuno)
130822	Proprietary PGN (Furuno)	130823	Proprietary PGN (Furuno)
130825	Proprietary PGN (Furuno)	130841	Proprietary PGN (Furuno)

5.4 Post Installation Initial Settings (Initialization Menu)

After mounting and wiring are completed, when the CAN bus/NMEA2000 network is turned on, the FI-70 will start up. If this is the first time the FI-70 has been powered, the [Initialization] menu is displayed. Set the language, units of measurement and your ship type in this menu.

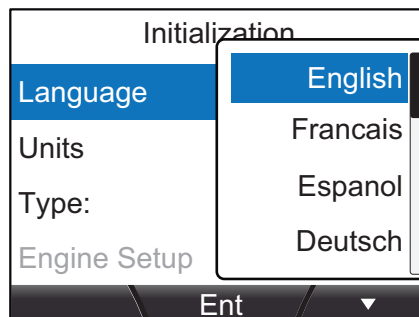

Follow the procedure below to set up the FI-70. After completion of this process, set up Data Sources (See section 4.9) and IF-NMEA FI (See section 4.6.1), as necessary.

- [Language] is selected, press the **function** key.
The FI-70 supports the following languages:
 - English
 - Spanish
 - Italian
 - Danish
 - Norwegian
 - French
 - German
 - Portuguese
 - Swedish
 - Finnish
- Press the **software** keys to select the appropriate language, then press the **function** key to apply the setting.
- Press the **software** keys to select [Units], then press the **function** key.
- Select the appropriate unit to adjust, then press the **function** key to display the available options. Options are outlined in the table on the following page.

Unit	Available options
Depth	[ft] (feet), [m] (meters), [fm] (fathoms), [PB] (passi/braza)
Speed	[kn] (knots), [km/h] (kilometers per hour), [MPH] (miles per hour)
Distance	[NM] (nautical miles), [km] (kilometers), [SM] (statute miles), [NM,yd]* (nautical miles, yards) [NM,m]* (nautical miles, meters), [km,m]* (kilometers, meters), [SM,yd]* (statute miles, yards)
Wind Speed	[kn] (knots), [km/h] (kilometers per hour), [MPH] (miles per hour), [m/s] (meters per second)
Temp. (Temperature)	°C (degrees Centigrade), °F (degrees Fahrenheit)
Fluid	l (liters), gal (gallons)
Atmos. Press. (Atmospheric Pressure)	hPa (hectopascals), mbar (millibars)
Engine Press. (Engine Pressure)	kPa (kilopascals), bar, psi (pounds per square inch)

*: The FI-70 can not display the trip and odometer by the meter and yard. For example, when [Distance] is set to [NM,yd], this equipment displays the trip and odometer only by the nautical mile.

5. Select the units as required, then press the **function** key.
6. Press the **Menu/Back** key to return to the [Initialization] menu.
7. Press the **software** keys to select [Type], then press the **function** key.
8. Select the appropriate vessel type (Power Boat, Sailboat or Engine Motor), then press the **function** key.

The default for category and page setup is preset according to the vessel type selected. These settings may be changed later as required.

Power Boat
Sailboat
Engine Motor

Page No.	[Power Boat]	[Sailboat]	[Engine Motor]
1	Compass	Compass	Engine
2	STW	AWA	Custom Box (Oil Press., Engine Temp., etc.)*
3	Water temperature graph	STW	OFF
4	Custom Box (POSN, SOG, COG)	Custom Box (STW)	OFF
5	Custom Box (POSN, W Temp., SOG)	Custom Box (POSN, AWS, STW)	OFF
6	OFF	OFF	OFF
7	OFF	OFF	OFF

*: The data displayed in the Custom Boxes is dependent on the number of engines set at the [Number of Engine] (See step 11).

9. Where the vessel type is set to [Engine Motor], press the **software** keys to select [Engine Setup], then press the **function** key. If the vessel type is set to [Power Boat] or [Sailboat], press the **Menu/Back** key to complete the initial setup.
10. With [Number of Engine] selected, press the **function** key.

5. INSTALLATION AND INITIAL SETTINGS

11. Press the **software** keys to select the number of engines on the vessel, then press the **function** key.
 The FI-70 may display up to three engines' data. The menu items displayed in the [Engine Setup] menu change according to the number of engines selected here.

<u>One engine</u>	<u>Two engines</u>	<u>Three engines</u>
Engine	Engine	Engine
Engine Assign: 1	Engine PORT: 1	Engine PORT: 1
Engine Alarm	Engine STBD: 2	Engine STBD: 2
	Engine Alarm	Engine Center: 3
		Engine Alarm
Ent ▼	Ent ▼	Ent ▼

12. Select the engine to be used as the data source.

Note: Engine numbers are assigned at each engine.

Where [Number of Engine] is set to [1]

- **[Engine Assign]:** Select the engine number to be displayed.

Where [Number of Engine] is set to [2]

- **[Engine PORT]:** Select the engine number to be displayed on the left side of the screen.
- **[Engine STBD]:** Select the engine number to be displayed on the right side of the screen.

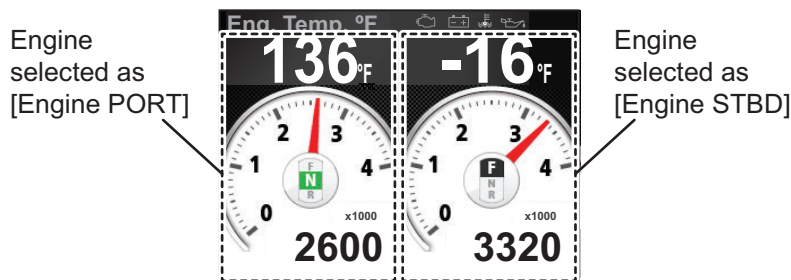

Where [Number of Engine] is set to [3]

- **[Engine PORT]:** Select the engine number to be displayed on the left side of the screen.
- **[Engine STBD]:** Select the engine number to be displayed on the right side of the screen.
- **[Engine Center]:** Select the engine number to be displayed in the middle of the screen.

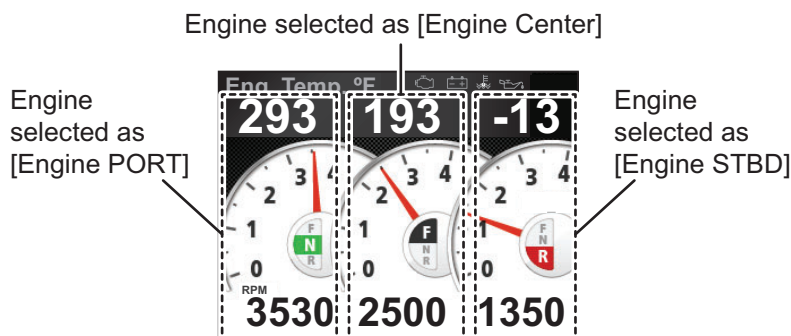

13. Press the **Menu/Back** key twice to close the menu.

6. MAINTENANCE, TROUBLESHOOTING

This chapter provides necessary information for keeping your equipment in good working order.

WARNING

Do not open the equipment.

Only qualified personnel should work inside the equipment.

NOTICE

Do not apply paint, anti-corrosive sealant or contact spray to coating or plastic parts of the equipment.

Those items contain organic solvents that can damage coating and plastic parts, especially plastic connectors.

6.1 Preventive Maintenance

The following procedures are recommended in order to maintain performance.

Check Item	Check point(s)	Remedy
Cabling	Check that all cabling is securely fastened and free of all types of corrosion.	Reconnect if necessary. Replace if necessary.
Unit case	Dust/grime on case.	Remove dust with a soft, lint free cloth. Where the dust is especially difficult to remove, use a mild strength household detergent to dampen the cloth. After cleaning, use a dry, soft lint free cloth of wipe the unit dry. Do not use acetone, thinners or other chemicals as they may damage the unit or remove markings.
LCD	Display is dimmed by dust/dirt buildup.	Clean the LCD carefully to prevent damage, with tissue paper and an LCD cleaner. To remove dirt or salt deposits, use an LCD cleaner and wipe slowly with lens paper so as to dissolve the dirt or salt. Change the paper frequently so the salt or dirt will not damage the LCD. Do not use solvents like thinner, acetone or benzine for cleaning.

6.2 Troubleshooting

If you feel the equipment is not functioning properly, follow the procedures in the table below to try to restore normal operation. If normal operation cannot be restored, do not attempt to check inside the cabinet. There are no user-serviceable parts inside.

Problem	Possible Cause	Remedy
Power cannot be turned on	<ul style="list-style-type: none"> Power is not supplied to the unit. Rear connector is disconnected or damaged. 	<ul style="list-style-type: none"> Check power supply. Rewire if necessary. Check cabling. Reconnect or replace if necessary.
Power is on but no data is displayed	<ul style="list-style-type: none"> Cable from sensor is damaged or disconnected. Sensor is damaged. 	<ul style="list-style-type: none"> Check sensor cabling. Reconnect or replace if necessary Check sensor. Replace if necessary.
Inaccurate data is displayed	<ul style="list-style-type: none"> Electromagnetic field generating equipment is in operation near the unit. Sensor is improperly aligned. 	<ul style="list-style-type: none"> Turn of all electromagnetic field generating equipment. Turn them on and off, one by one, checking the display each time. Relocate the offending equipment if necessary. Check installation settings on sensor and FI-70.
The message "Maintenance is needed. Engine Hour. *****" appears when the FI-70 starts up.	<ul style="list-style-type: none"> Engine operating hours have reached maintenance level. <p>Note: The maintenance level depends on the engine specifications.</p>	<ul style="list-style-type: none"> Press any key to close the message. Request maintenance from the engine manufacturer after returning port.

6.3 Alarm Log

The [Alarm Log] stores all alarms released after power is applied to the FI-70. The log is cleared when the FI-70 is turned off.

To display the [Alarm Log], press the **Menu/Back** key, select [Alarm Log], then press the **function** key.

How to interpret the alarm log

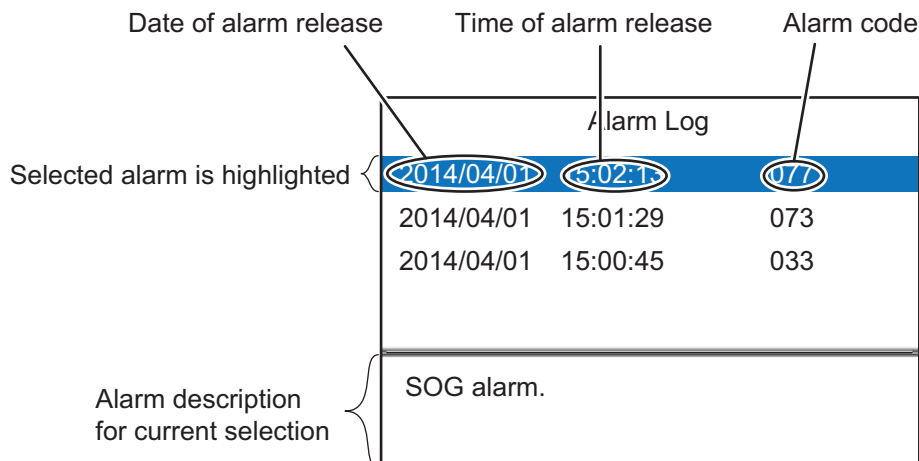





The following table shows the alarms which may be displayed on the FI-70, in priority order, with their respective pop-up messages.

For information on how to set alarms see chapter 3.

Alarm code	Pop-up message	Reason/Possible remedy
001	Check Engine.	Engine warning/alarm. Check the engine and engine sensor.
003	Low Oil Pressure.	Oil pressure warning/alarm. Check the oil pressure and pressure sensor.
005	Over Temperature.	Coolant high temperature warning/alarm. Check the coolant temperature and temperature sensor.
007	Charge Indicator.	Battery charge warning/alarm. Check the battery, recharge or replace if necessary.
011	CPA Alarm, TCPA Alarm.	Dangerous target warning/alarm. Adjust course to avoid collision.
021	Low voltage alarm.	Battery voltage warning/alarm. Check the battery voltage, replace if necessary.
031	Missing depth data.	Depth data timeout. Check connection to depth sensor and sounder.
033	Depth alarm.	Depth is above/below threshold. Take appropriate measures.
041	Missing position data.	Connection to EPFS device has timed out. Check connections to EPFS device.
043	Anchor alarm.	Anchor distance/depth is over threshold. Check anchor and vessel position.
051	Missing wind data.	Connection to sensor has timed out. Check connections to wind sensor.
053	Max TWS alarm.	True wind speed is over threshold. Take appropriate measures.
055	Wind shift alarm.	Wind direction has shifted abruptly. Take appropriate measures.
057	Low AWA alarm.	Port-side wind is over threshold. Take appropriate measures.
059	High AWA alarm.	Starboard-side wind is over threshold. Take appropriate measures.
061	Missing water temp data.	Connection to sensor has timed out. Check connections to water temp sensor.
063	Water temp alarm.	Water temperature is over/under threshold.
071	Missing STW data.	Connection to sensor has timed out. Check connections to speed sensor.
073	STW alarm.	Speed is over/under threshold. Adjust speed appropriately.
075	Missing SOG data.	Connection to sensor has timed out. Check connections to speed sensor.
077	SOG alarm.	Speed is over/under threshold. Adjust speed appropriately.
081	Missing trip data.	Connection to plotter has timed out. Check connections to plotter.
083	Trip alarm.	Distance/time has been reached or exceeded.

6.4 Engine Error Icons

When the FI-70 receives error information from a connected engine, the data display for that engine shows a flashing orange-red icon for the error. Each icon and its meaning are shown in the table below.

Indicator	Cause/location of problem
	Engine control system.
	Battery.
	Coolant.
	Oil pressure.

6.5 How to Diagnostically Test the FI-70

The FI-70 has a [Diagnostic] menu where you may check the keyboard, screen and also conduct a self-test on the FI-70.

1. Press the **Menu/Back** key to open the main menu.
2. Press the **software** keys to select [System], then press the **function** key.
3. Press the **software** keys select [Diagnostic], then press the **function** key.
4. Press the **software** keys to select the appropriate test, then press the **function** key to start the test.

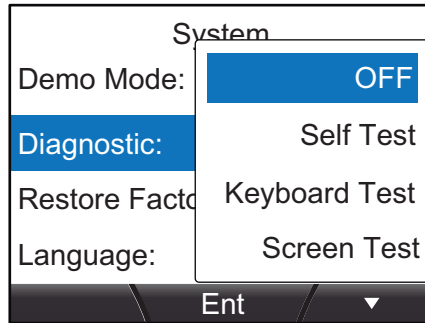

5. Press the **Menu/Back** key to close the menu.

6.5.1 Self test

The self test results are displayed as shown in the example figure below. If [RAM], [ROM] or [Backup] display as "NG", consult a qualified FURUNO technician for service.

```

Self Test
ROM:OK  2651031-xx.xx
        2651030-xx.xx
RAM:OK  Backup:OK
Voltage:15.4V
CAN Unique ID:4660
CAN Address:0
System Instance:0
Device Instance:0
  
```

ROM: Results for ROM test and related program numbers.

RAM: Results for RAM test.

Backup: Results for backup data test.

Voltage: Input power voltage.

CAN Unique ID: This unit's unique CAN bus (NMEA2000) ID.

CAN Address: This unit's CAN bus (NMEA2000) network address.

System/Device Instance: This unit's ID number.

To change these numbers, consult your place of purchase.

"xx.xx" indicates program versions.

Press the **Menu/Back** key at any time to exit the [Self Test].

6.5.2 Keyboard test

The keyboard test allows you to check each key is functioning normally.

Note: Alarms are not displayed during this test.

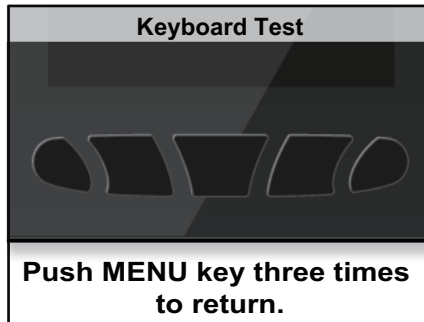

Press any key. If the key is functioning normally, the color for that key is changed to blue. Pressing the key again will change the color back to black.

To close the keyboard test, press the **Menu/Back** three times.

6.5.3 Screen test

The screen test checks the LCD colors, brilliance and general performance. During the screen test, press the function key to change the display as shown in the figure below.

Note: Alarms are not displayed during this test.

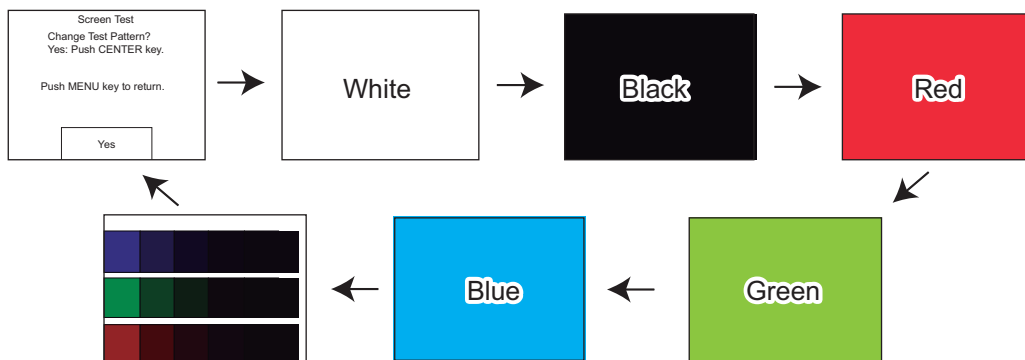

Press the **Menu/Back** key at any time to exit the screen test.

APPENDIX 1 MENU TREE

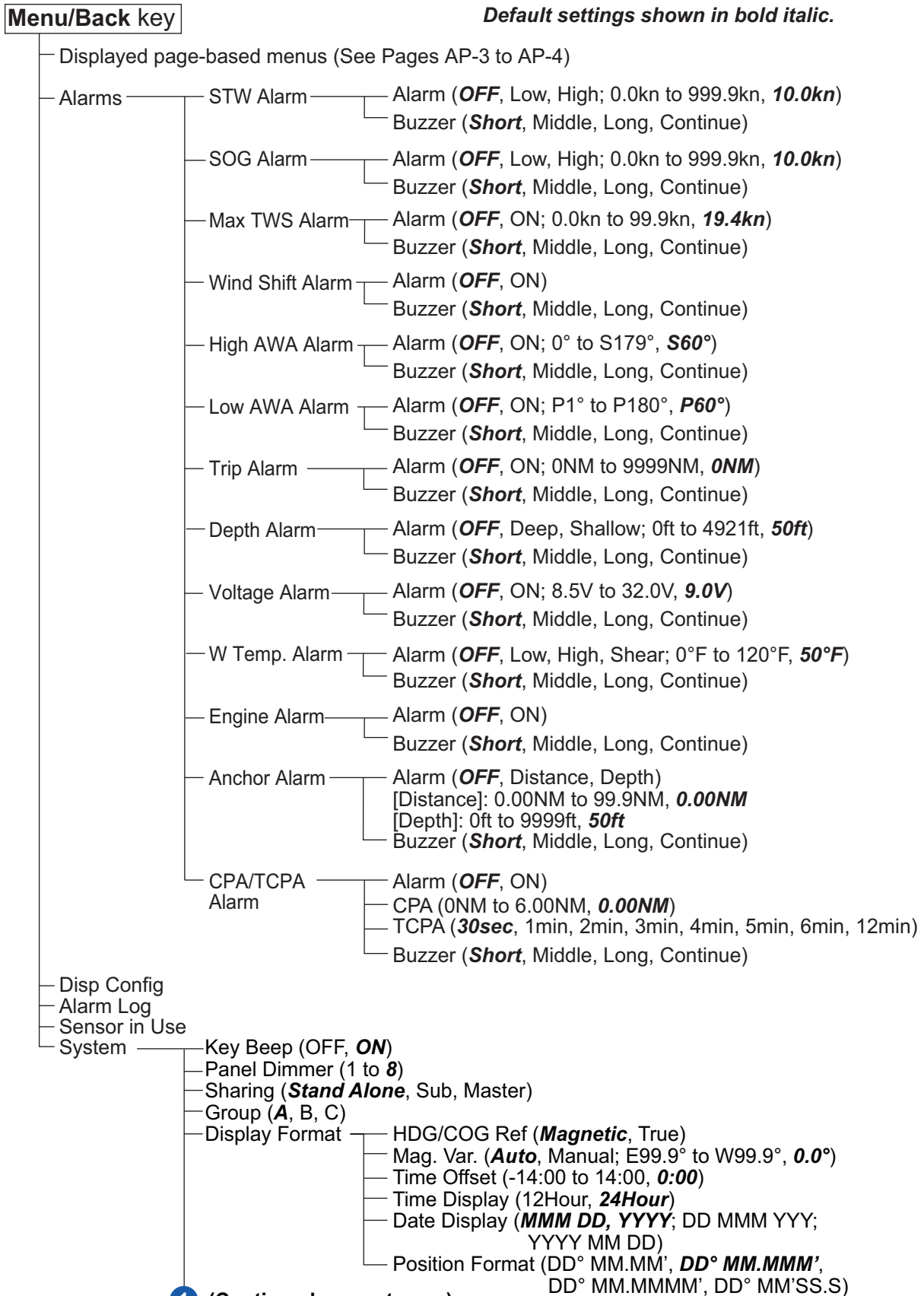

1 (Continued on next page)

1 (Continued from previous page)

- Engine Setup
 - Number of Engine (1 to 3, **1**)
 - Engine Assign (1 to 4, **1**) Where [Number of Engine] is set to [1]
 - Engine PORT (1 to 4, **1**) Where [Number of Engine] is set to [2] or [3]
 - Engine STBD (1 to 4, **2**) Where [Number of Engine] is set to [2] or [3]
 - Engine Center (1 to 4, **3**) Where [Number of Engine] is set to [3]
 - Engine Refresh
- Scale Range
 - Speed (**0-20kn**, 0-40kn, 0-80kn)
 - Engine RPM (**0-4×1000rpm**, 0-6×1000rpm, 0-8×1000rpm)
 - Boost (**0-30psi**, 0-70psi, 0-150psi, 0-360psi, 0-440psi)
 - Eng. Temp. (**150-250°F**, 120-300°F)
 - Oil Press. (**0-30psi**, 0-70psi, 0-150psi, 0-360psi, 0-440psi)
 - Oil Temp. (**150-250°F**, 120-300°F)
 - Coolant P (**0-30psi**, 0-70psi, 0-150psi, 0-360psi, 0-440psi)
 - Gear Oil P (**0-30psi**, 0-70psi, 0-150psi, 0-360psi, 0-440psi)
 - Gear Oil T (**150-250°F**, 120-300°F)
 - Voltage (**8-16V**, 16-32V)
- IF-NMEAFI
 - Select IF
 - Category (**Wind**, ST800/ST850, Fuel, Fresh Water, Waste Water, Live Well, Oil, Black Water)
 - Resistance Full (0 to 500ohm, **33.5ohm**)
 - Resistance Mid (0 to 500ohm, **103.00ohm**)
 - Resistance Empty (0 to 500ohm, **240.00ohm**)
 - Capacity (0 to 2650gal)
 - IF-NMEAFI Test
 - Refresh
- SC-30 Setup
 - Select SC
 - WAAS Mode (ON, **OFF**)
 - Heading Offset (-180.0° to +180.0°, **0.0°**)
 - Pitch Offset (-90.0° to +90.0°, **0.0°**)
 - Roll Offset (-90.0° to +90.0°, **0.0°**)
- I/O Setup
 - Incoming PGN
 - Device List
 - NMEA2000 Refresh
 - Wiring Info
- Data Source
 - Position
 - Heading
 - STW
 - SOG
 - Navigation
 - Depth
 - W Temp.
 - Wind
 - AIS
 - Tank1 to Tank6
- Data Calibration
 - Adjust(STW) (0.30 to 2.50, **1.00**)
 - Wind Damping (**0s** to 12s, **3s**)
 - Adjust(W Speed) (0.30 to 2.50, **1.00**)
 - W Angle Response (**0s** to 12s, **4s**)
 - Offset(W Angle) (180° to P179°, **0°**)
 - Offset(HDG) (180° to W179°, **0°**)
 - Offset(Depth) (-327.8ft to +327.8ft, **0.0ft**)
 - Offset(W Temp.) (-179.8°F to 179.8°F, **0.0°F**)
- Demo Mode (**OFF**, ON)
- Diagnostic (**OFF**, Self Test, Keyboard Test, Screen Test)
- Restore Factory Default
- Language (**English**, Francais, Espanol, Deutsch, Italiano, Potugues, Dansk, Svenska, Norsk, Suomi)
- Units
 - Depth (m, **ft**, fm, PB)
 - Speed (**kn**, km/h, MPH)
 - Distance (**NM**, km, SM, NM,yd, NM,m, km,m, SM,yd)
 - Wind Speed (**kn**, km/h, MPH, m/s)
 - Temp (°C, **°F**)
 - Atmos. Press. (**hPa**, mbar)
 - Engine Press. (kPa, bar, **psi**)

◆ **Compass**

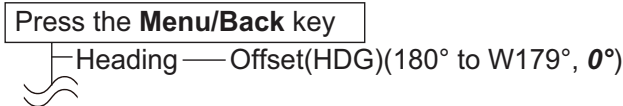

◆ **STW**

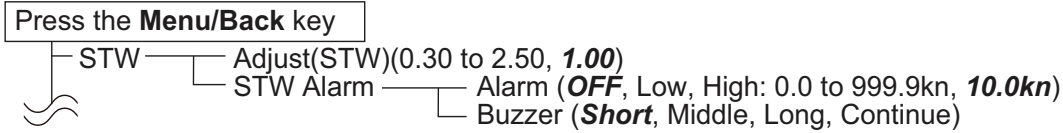

◆ **SOG**

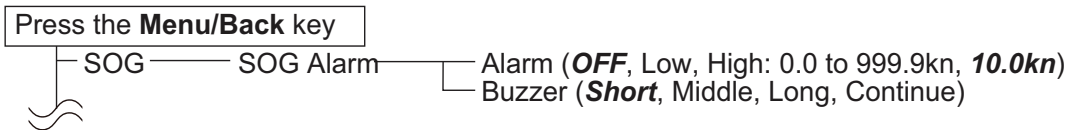

◆ **AWA, TWA, CH AWA, CH TWA, Ground Wind**

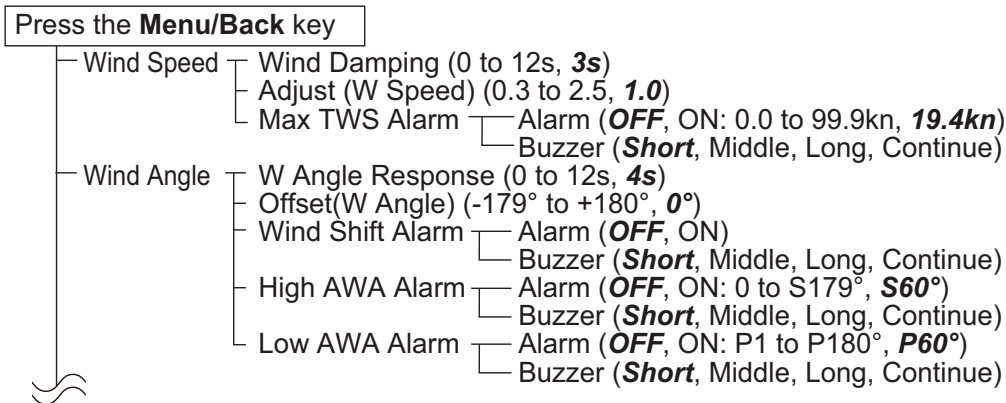

◆ **Engine**

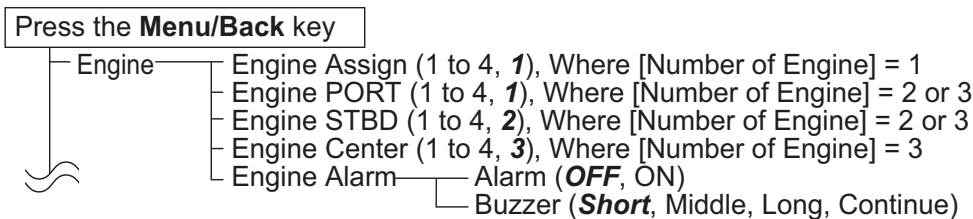

◆ **1Graph, 2Graphs**

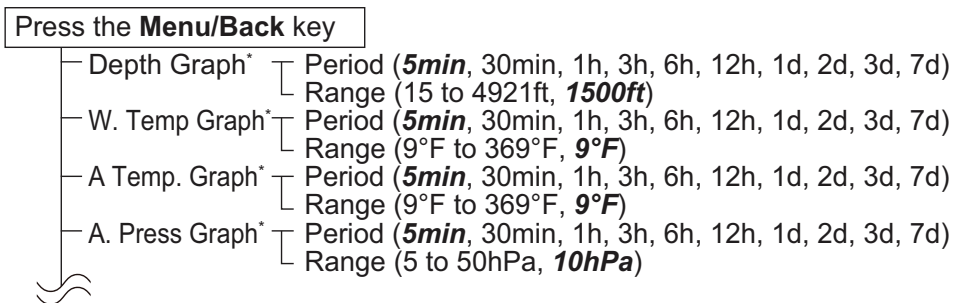

*: Depends on displayed graph data

◆ AIS

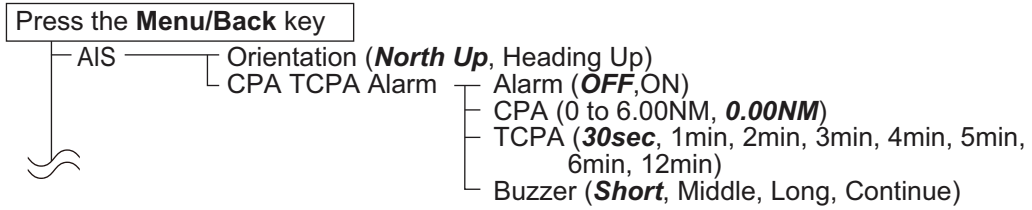

◆ Custom Box

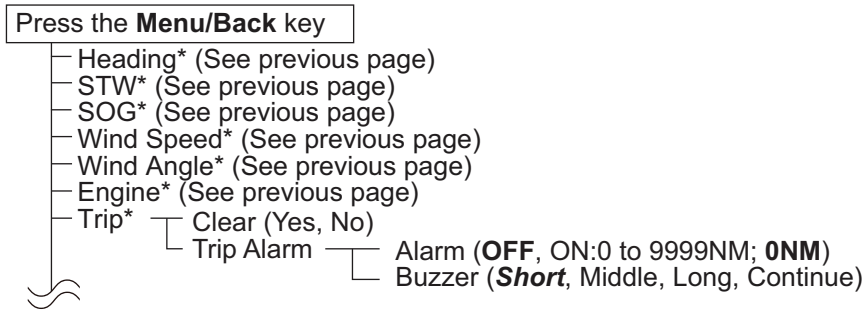

*: Dependant on data displayed in custom box.

SPECIFICATIONS OF COLOR INSTRUMENT FI-70

1 GENERAL

- | | | |
|-----|--------------|---|
| 1.1 | Screen | 4.1-inch color TFT LCD, QVGA (320 x 240) |
| 1.2 | Backlight | 8 steps |
| 1.3 | Buzzer | 55 dB or more |
| 1.4 | Display mode | Analog meter, Graph, Highway, Race timer, simplified AIS,
Data box |
| 1.5 | Display data | Ship's speed, Wind speed/direction, Bearing, Track, Nav data,
Hull data, Engine data, Tank gauge, Water depth,
Environmental information, Voltage |
| 1.6 | Language | English, French, Spanish, Portuguese, German, Italian,
Norwegian, Danish, Swedish, Finnish |

2 INTERFACE

- | | | |
|-----|---------------------|---|
| 2.1 | Number of port | NMEA2000: 1 port |
| 2.2 | PGN (NMEA2000 V2.0) | |
| | Input | 059904, 060928, 061184, 126208/720/992/996,
127237/245/250/251/257/258/488/489/493/497/505, 128259/267,
129025/026/029/033/038/039/040/283/284/285/538/794/809/810,
130306/310/311/312/313/314/316/576/577,
130816/818/821/822/825/880/841, 65280 |
| | Output | 059392/904, 060928, 061184, 126208/464/720/993/996,
130314/816/821/822/823/825/841 |

3 POWER SUPPLY

12-15 VDC: 0.25 A max. (LEN: 4)

4 ENVIRONMENTAL CONDITIONS

- | | | |
|-----|----------------------|----------------------|
| 4.1 | Ambient temperature | -15°C to +55°C |
| 4.2 | Relative humidity | 93% or less at +40°C |
| 4.3 | Degree of protection | IP56 |
| 4.4 | Vibration | IEC 60945 Ed.4 |

5 UNIT COLOR



N2.5

PACKING LIST

26AL-X-9851 -3 1/1

FI-70

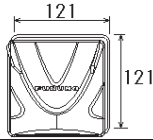
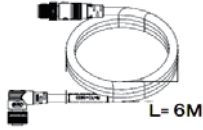
A-1

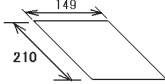
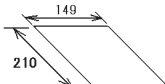

NAME	OUTLINE	DESCRIPTION/CODE No.	Q'TY
ユニット UNIT			
カラーインストルメント COLOR INSTRUMENT		FI-70 000-027-045-00	1
工事材料 INSTALLATION MATERIALS			
ケーブル(クミヒン) CABLE ASSEMBLY		FI-70-0600 001-490-200-00	1
工事材料 INSTALLATION MATERIALS		CP26-02001 001-336-500-00	1
図書 DOCUMENT			
フラッシュマウント型紙 FLUSH MOUNTING TEMPLATE		C72-01402-* 000-190-064-1*	1
ユーザーハンドブック USER'S HANDBOOK		*72-01403-* 000-190-825-1*	1

(略図の寸法は、参考値です。 DIMENSIONS IN DRAWING FOR REFERENCE ONLY.)

C7281-Z01-D

FURUNO

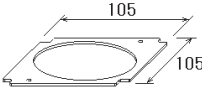
CODE NO.	001-336-500-00	26AL-X-9401 -0
TYPE	CP26-02001	1/1

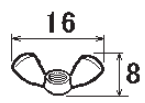
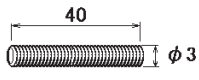
工事材料表 INSTALLATION MATERIALS					
番号 NO.	名称 NAME	略図 OUTLINE	型名/規格 DESCRIPTIONS	数量 Q' TY	用途/備考 REMARKS
1	Fマウントスポンジ F MOUNT SPONGE		26-008-1011-0 CODE NO. 100-394-750-10	1	
2	ミカキ丸平座金 FLAT WASHER		M3 SUS304 CODE NO. 000-167-453-10	2	
3	ハネ座金 SPRING WASHER		M3 SUS304 CODE NO. 000-167-404-10	2	
4	蝶ナット WING NUT		M3 SUS304 CODE NO. 000-167-826-10	2	
5	寸切ボルト BOLT		M3X40 SUS304 CODE NO. 000-167-804-10	2	

型式/コード番号が2段の場合、下段より上段に代わる過渡期品であり、どちらかが入っています。なお、品質は変わりません。

TWO TYPES AND CODES MAY BE LISTED FOR AN ITEM. THE LOWER PRODUCT MAY BE SHIPPED IN PLACE OF THE UPPER PRODUCT. QUALITY IS THE SAME.

(略図の寸法は、参考値です。 DIMENSIONS IN DRAWING FOR REFERENCE ONLY.)

FURUNO ELECTRIC CO., LTD.

C7281-M01-A

表1 TABLE 1

寸法区分 (mm) DIMENSION	公差 (mm) TOLERANCE
L ≤ 50	±1.5
50 < L ≤ 100	±2.5
100 < L ≤ 500	±3

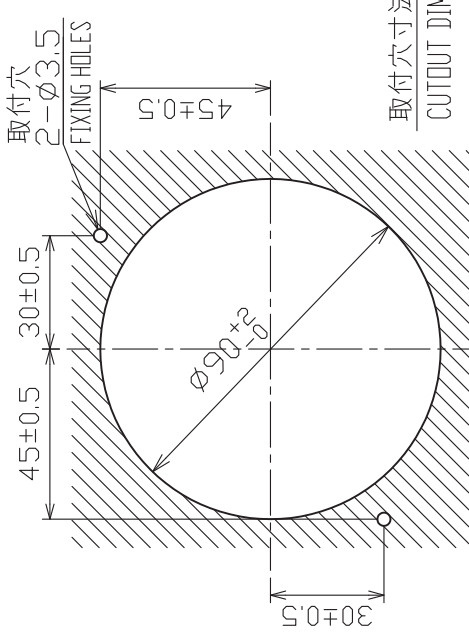

取付穴
FIXING HOLES
取付寸法
CUTOUT DIMENSIONS

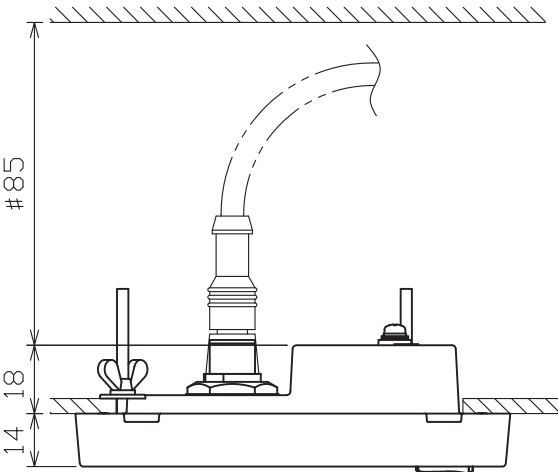

オプションコネクタ使用時
FOR OPTIONAL CONNECTOR USING

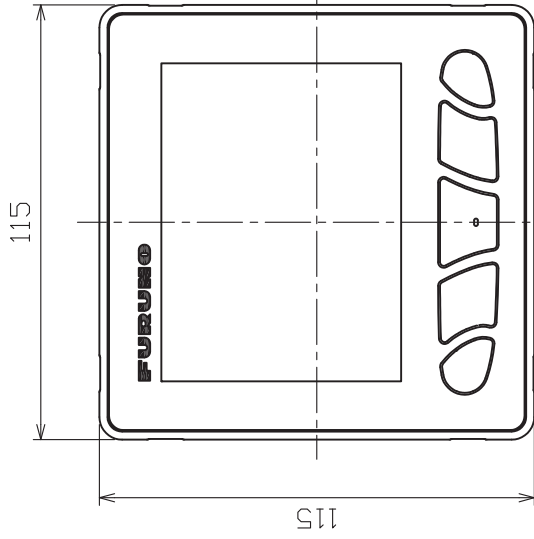
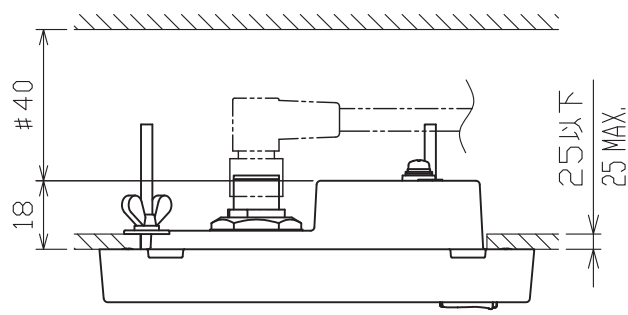
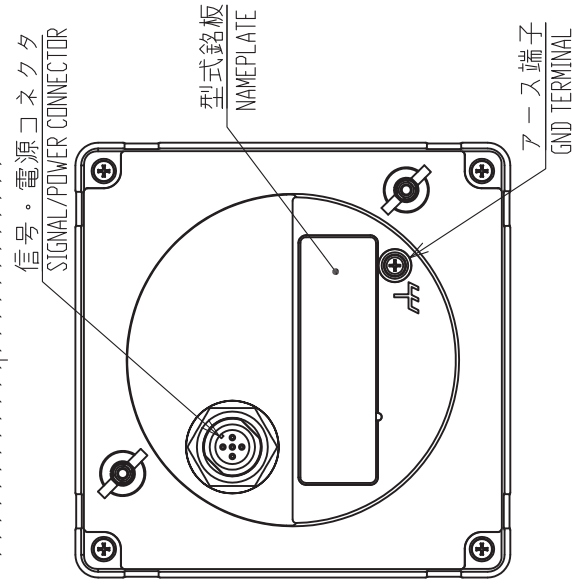

- 注記 1) 指定外の寸法公差は表1による。
 2) #印寸法は最小サービス空間とする。
 3) 取付には、M3×40寸切りボルト、M3平座金・ばね座金・蝶ナットを使用のこと。
- NOTE 1. TABLE 1 INDICATES TOLERANCE OF DIMENSIONS WHICH IS NOT SPECIFIED,
 2. # MINIMUM SERVICE CLEARANCE.
 3. USE M3×40 STUD BOLTS AND M3 P.W. /S.W./WING NUTS FOR FIXING THE UNIT.

DRAWN	21/Apr/2017	I.YAMASAKI	TITLE	FI-70
CHECKED	21/Apr/2017	H.MAKI	名称	カラーインストルメント (埋込装備)
APPROVED	24/Apr/2017	H.MAKI	外寸図	
SCALE	1/2	1/22 kg	NAME	COLOR INSTRUMENT (FLUSH MOUNT)
JWG.No.	C7281-601-C	26-008-100G-5	OUTLINE DRAWING	

表1 TABLE 1

寸法区分 (mm) DIMENSION	公差 (mm) TOLERANCE
L ≤ 50	±1.5
50 < L ≤ 100	±2.5
100 < L ≤ 500	±3

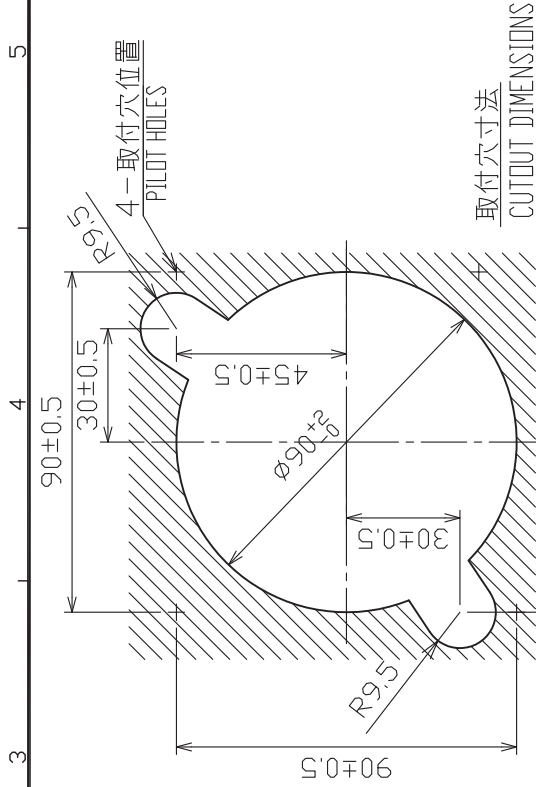

取付穴寸法
CUTOUT DIMENSIONS

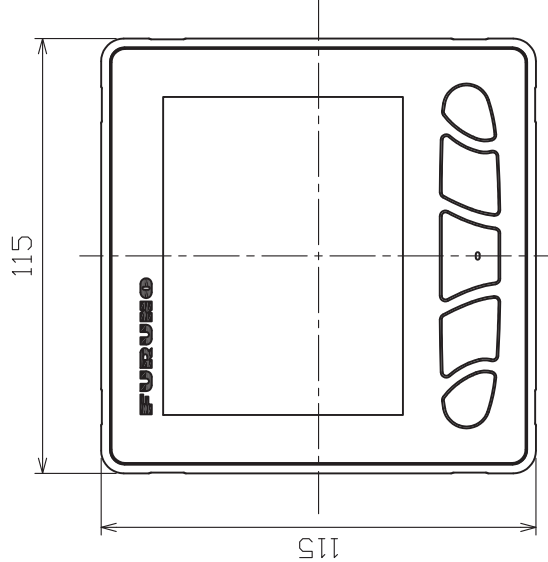
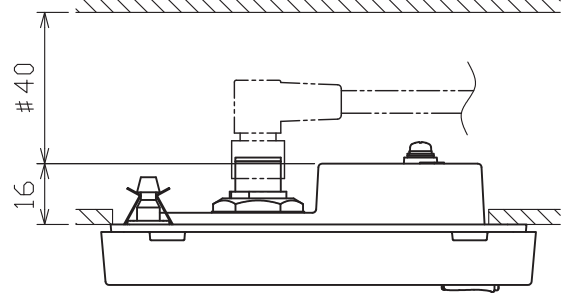
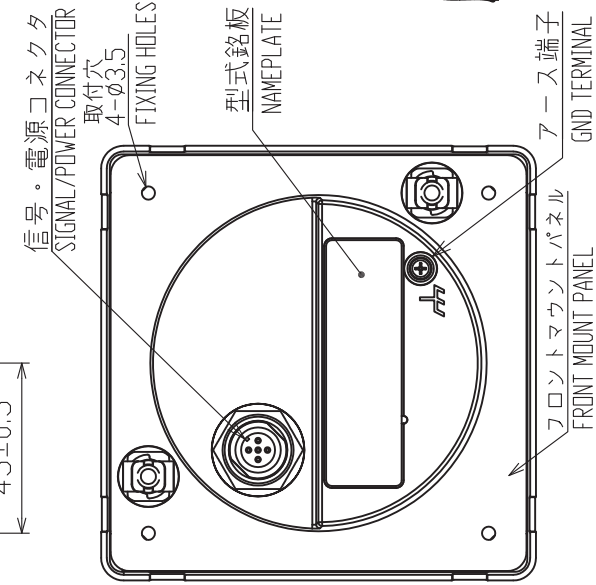
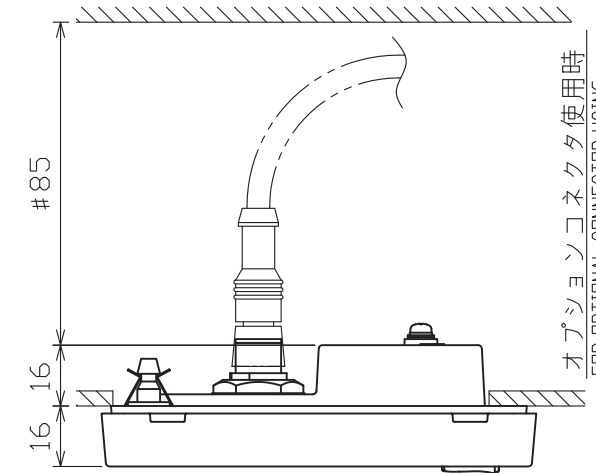

- 注記 1) 指定外の寸法公差は表 1 による。
 2) # 印寸法は最小サービス空間とする。
 3) 取付用ネジは、+ サラタツピンネジ呼び径 3 × 2.0 を使用のこと。
- NOTE 1. TABLE 1 INDICATES TOLERANCE OF DIMENSIONS WHICH IS NOT SPECIFIED.
 2. # MINIMUM SERVICE CLEARANCE.
 3. USE COUNTERSUNK HEAD TAPPING SCREWS $\phi 3 \times 2.0$ FOR FIXING THE UNIT.

DRAWN	21/Apr/2017	T. YAMASAKI	TITLE	FI-70
CHECKED	21/Apr/2017	H. MAKI	名称	カラーインストルメント (フロントマウント)
APPROVED	24/Apr/2017	H. MAKI	外寸図	
SCALE	1/2	質量 0.24 kg 容積 100 cc 質量は付属品・ケーブルを含まず。 MASS DOES NOT INCLUDE CABLE AND ASSY.	仕様	COLOR INSTRUMENT (FRONT MOUNT)
FIG. No.	C7281-603-C	REF. No.	26-008-102G-2	OUTLINE DRAWING

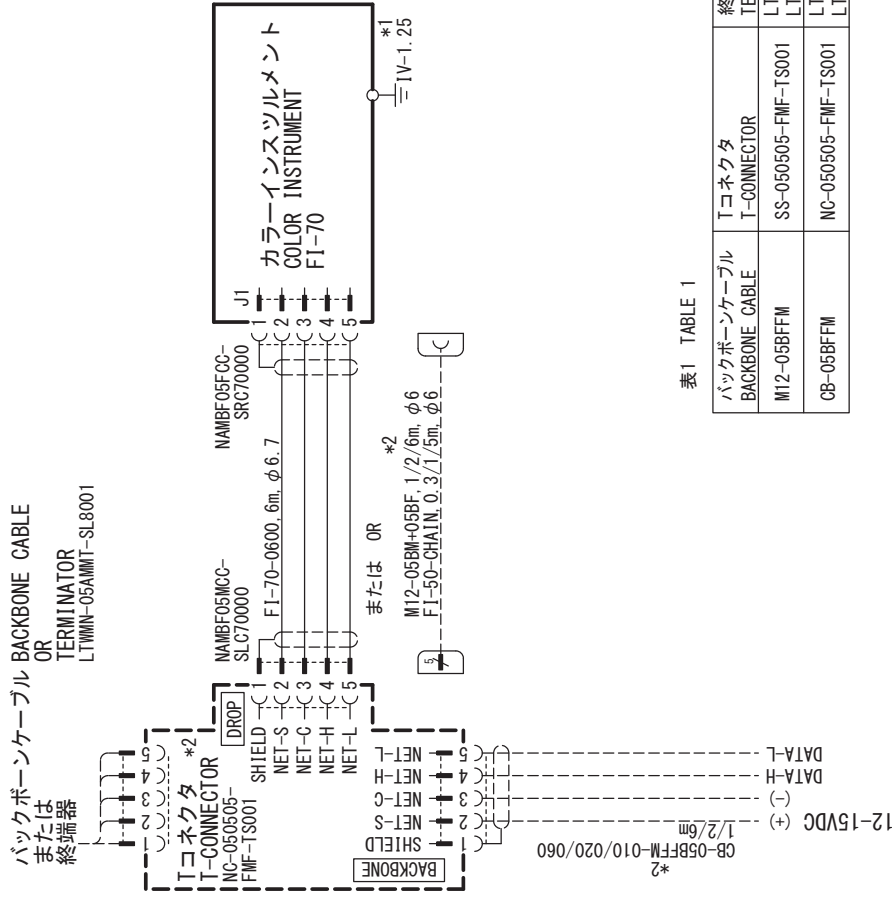

注記

- * 1) 造船所手配。
- * 2) オプション。
- * 3) ケーブル、Tコネクタ、終端器の関係は表 1 による。

NOTE

- * 1: THE SHIPYARD SUPPLY.
- * 2: OPTION.
- * 3: TABLE 1 INDICATES RELATIONSHIP AMONG CABLE, T-CONNECTOR AND TERMINATOR.

DRAWN	11/Apr/2017	T. YAMASAKI	TITLE	FI-70
CHECKED	11/Apr/2017	H. MAKI	名称	カラーインストルメント
APPROVED	12/Apr/2017	H. MAKI		相互結線図
SCALE	1/MASS	kg	NAME	COLOR INSTRUMENT
DWG. No.	CT281-C01-C			INTERCONNECTION DIAGRAM
			REF. No.	

バックボーンケーブル
BACKBONE CABLE
OR
TERMINATOR
LTIW1N-05AMMT-SL8001

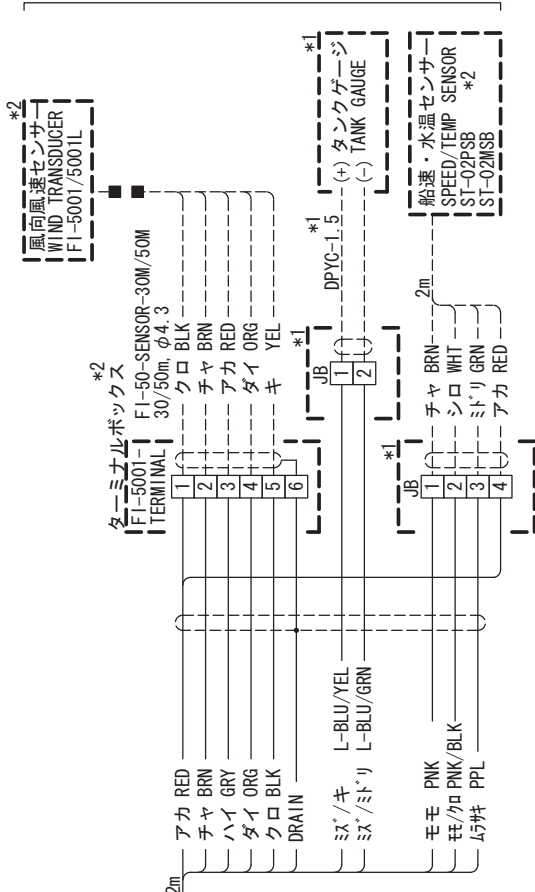
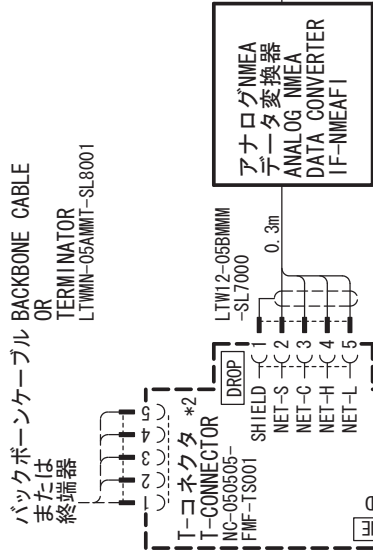

いずれか選択
SELECT EITHER

注記
* 1) 造船所手配。
* 2) オプション。
NOTE
*1: THE SHIPYARD SUPPLY.
*2: OPTION.

DRAWN	10/Dec/2014	T. YAMASAKI	TITLE	IF-NMEA-F1
CHECKED	10/Dec/2014	H. MAKI	名称	アナログNMEAデータ変換器
APPROVED	11/Dec/2014	H. MAKI		相互結線図
SCALE	MASS	kg	NAME	ANALOG NMEA DATA CONVERTER
DWG. No.	C7281-C02-B		REF. No.	INTERCONNECTION DIAGRAM

INDEX

A

AIS target details.....	2-10
Alarms	
Alarm codes	6-3
Alarm list	6-3
Alarm log.....	6-2
Anchor.....	3-8
audio pattern	3-1
CPA/TCPA	3-9
Crosswind	3-3
Depth.....	3-5
Engine.....	3-7
Engine error icons.....	6-4
Low voltage.....	3-5
STW/SOG	3-2
Trip alarm.....	3-4
TWS	3-3
Water temperature	3-6
Wind shift	3-3

B

Backlights.....	1-4
Brilliance	1-2

C

Categories.....	1-4
AIS	2-9
compass.....	2-1
custom box.....	2-11
engine	2-3
graph.....	2-4
highway.....	2-5
rudder.....	2-5
speed	2-2
timer.....	2-6
wind.....	2-8
Controls.....	1-1

D

Data boxes displayable data.....	2-14
Data calibration	4-13
Data offset.....	4-13
Data source setup.....	4-12
Demo mode	4-15
Diagnostic menu	4-15, 6-5
keyboard test.....	6-6
screen test.....	6-6
self test.....	6-5
Dimmer	1-4
Display format	4-4
Display scale range.....	4-7

E

Engine settings	4-5
-----------------------	-----

F

Factory default restore	4-15
FI-70 shared settings	4-3

G

Group settings.....	4-3
---------------------	-----

H

How to change pages	1-5
---------------------------	-----

I

I/O Setup menu	4-11
CAN Bus refresh	4-11
Device list.....	4-11
Incoming PGN.....	4-11
Wiring info	4-11
IF-NMEAFI setup	4-8
menu settings.....	4-8
reset	4-9
test	4-9
Initial setup.....	5-10
Initialization menu	5-10
Input PGNs	5-9

K

Key beeps on/off	1-3
------------------------	-----

L

Language settings.....	4-14
------------------------	------

M

Menu operation	
AIS	2-10
data boxes.....	2-12
timers	2-7
Menu overview	1-2
Mounting	
flushmount.....	5-2
frontmount	5-3
guidelines	5-1

N

Network sharing settings.....	4-1
levels	4-2

O

Operation	1-1
Output PGNs.....	5-10

P

Page setup	1-6
Power on/off	1-1
Preventative maintenance.....	6-1

R

Resizing data boxes.....	2-13
--------------------------	------

S

Screen categories	1-4
-------------------------	-----

T

Troubleshooting 6-2

U

Units of measurement 4-14

W

Wiring 5-5

CAN bus definition 5-6

connection 5-5

FI-5001/L connection 5-6

FI-5002 cable fabrication 5-8

FI-5002 connection 5-7

grounding 5-6

NMEA2000 port 5-5

terminal resistors 5-8

FURUNO Worldwide Warranty for Pleasure Boats (Except North America)

This warranty is valid for products manufactured by Furuno Electric Co. (hereafter FURUNO) and installed on a pleasure boat. Any web based purchases that are imported into other countries by anyone other than a FURUNO certified dealer may not comply with local standards. FURUNO strongly recommends against importing these products from international websites as the imported product may not work correctly and may interfere with other electronic devices. The imported product may also be in breach of the local laws and mandated technical requirements. Products imported into other countries as described previously shall not be eligible for local warranty service.

For products purchased outside of your country please contact the national distributor of Furuno products in the country where purchased.

This warranty is in addition to the customer's statutory legal rights.

1. Terms and Conditions of Warranty

FURUNO guarantees that each new FURUNO product is the result of quality materials and workmanship. The warranty is valid for a period of 2 years (24 months) from the date of the invoice, or the date of commissioning of the product by the installing certified dealer.

2. FURUNO Standard Warranty

The FURUNO standard warranty covers spare parts and labour costs associated with a warranty claim, provided that the product is returned to a FURUNO national distributor by prepaid carrier.

The FURUNO standard warranty includes:

- Repair at a FURUNO national distributor
- All spare parts for the repair
- Cost for economical shipment to customer

3. FURUNO Onboard Warranty

If the product was installed/commissioned and registered by a certified FURUNO dealer, the customer has the right to the onboard warranty.

The FURUNO onboard warranty includes

- Free shipping of the necessary parts
- Labour: Normal working hours only
- Travel time: Up to a maximum of two (2) hours
- Travel distance: Up to a maximum of one hundred and sixty (160) KM by car for the complete journey

4. Warranty Registration

For the Standard Warranty - presentation of product with serial number (8 digits serial number, 1234-5678) is sufficient. Otherwise, the invoice with serial number, name and stamp of the dealer and date of purchase is shown.

For the Onboard Warranty your FURUNO certified dealer will take care of all registrations.

5. Warranty Claims

For the Standard Warranty - simply send the defective product together with the invoice to a FURUNO national distributor. For the Onboard Warranty – contact a FURUNO national distributor or a certified dealer. Give the product's serial number and describe the problem as accurately as possible.

Warranty repairs carried out by companies/persons other than a FURUNO national distributor or a certified dealer is not covered by this warranty.

6. Warranty Limitations

When a claim is made, FURUNO has a right to choose whether to repair the product or replace it.

The FURUNO warranty is only valid if the product was correctly installed and used. Therefore, it is necessary for the customer to comply with the instructions in the handbook. Problems which result from not complying with the instruction manual are not covered by the warranty.

FURUNO is not liable for any damage caused to the vessel by using a FURUNO product.

The following are excluded from this warranty:

- a. Second-hand product
- b. Underwater unit such as transducer and hull unit
- c. Routine maintenance, alignment and calibration services.
- d. Replacement of consumable parts such as fuses, lamps, recording papers, drive belts, cables, protective covers and batteries.
- e. Magnetron and MIC with more than 1000 transmitting hours or older than 12 months, whichever comes first.
- f. Costs associated with the replacement of a transducer (e.g. Crane, docking or diver etc.).
- g. Sea trial, test and evaluation or other demonstrations.
- h. Products repaired or altered by anyone other than the FURUNO national distributor or an authorized dealer.
- i. Products on which the serial number is altered, defaced or removed.
- j. Problems resulting from an accident, negligence, misuse, improper installation, vandalism or water penetration.
- k. Damage resulting from a force majeure or other natural catastrophe or calamity.
- l. Damage from shipping or transit.
- m. Software updates, except when deemed necessary and warrantable by FURUNO.
- n. Overtime, extra labour outside of normal hours such as weekend/holiday, and travel costs above the 160 KM allowance
- o. Operator familiarization and orientation.

FURUNO Electric Company, March 1, 2011

FURUNO Warranty for North America

FURUNO U.S.A., Limited Warranty provides a twenty-four (24) months LABOR and twenty-four (24) months PARTS warranty on products from the date of installation or purchase by the original owner. Products or components that are represented as being waterproof are guaranteed to be waterproof only for, and within the limits, of the warranty period stated above. The warranty start date may not exceed eighteen (18) months from the original date of purchase by dealer from Furuno USA and applies to new equipment installed and operated in accordance with Furuno USA's published instructions.

Magnetrons and Microwave devices will be warranted for a period of 12 months from date of original equipment installation.

Furuno U.S.A., Inc. warrants each new product to be of sound material and workmanship and through its authorized dealer will exchange any parts proven to be defective in material or workmanship under normal use at no charge for a period of 24 months from the date of installation or purchase.

Furuno U.S.A., Inc., through an authorized Furuno dealer will provide labor at no cost to replace defective parts, exclusive of routine maintenance or normal adjustments, for a period of 24 months from installation date provided the work is done by Furuno U.S.A., Inc. or an AUTHORIZED Furuno dealer during normal shop hours and within a radius of 50 miles of the shop location.

A suitable proof of purchase showing date of purchase, or installation certification must be available to Furuno U.S.A., Inc., or its authorized dealer at the time of request for warranty service.

This warranty is valid for installation of products manufactured by Furuno Electric Co. (hereafter FURUNO). Any purchases from brick and mortar or web-based resellers that are imported into other countries by anyone other than a FURUNO certified dealer, agent or subsidiary may not comply with local standards. FURUNO strongly recommends against importing these products from international websites or other resellers, as the imported product may not work correctly and may interfere with other electronic devices. The imported product may also be in breach of the local laws and mandated technical requirements. Products imported into other countries, as described previously, shall not be eligible for local warranty service.

For products purchased outside of your country please contact the national distributor of Furuno products in the country where purchased.

WARRANTY REGISTRATION AND INFORMATION

To register your product for warranty, as well as see the complete warranty guidelines and limitations, please visit www.furunousa.com and click on "Support". In order to expedite repairs, warranty service on Furuno equipment is provided through its authorized dealer network. If this is not possible or practical, please contact Furuno U.S.A., Inc. to arrange warranty service.

FURUNO U.S.A., INC.
Attention: Service Coordinator
4400 N.W. Pacific Rim Boulevard
Camas, WA 98607-9408
Telephone: (360) 834-9300
FAX: (360) 834-9400

Furuno U.S.A., Inc. is proud to supply you with the highest quality in Marine Electronics. We know you had several choices when making your selection of equipment, and from everyone at Furuno we thank you. Furuno takes great pride in customer service.

EC Declaration of Conformity



We **FURUNO ELECTRIC CO., LTD.**

(Manufacturer)

9-52 Ashihara-Cho, Nishinomiya City, 662-8580, Hyogo, Japan

(Address)

declare under our sole responsibility that the product

**COLOR INSTRUMENT FI-70 and
ANALOG NMEA DATA CONVERTER IF-NMEAFI**

(Model name, type number)

to which this declaration relates is in conformity with the following standard(s) or other normative document(s)

IEC 60945 Ed.4.0: 2002, clauses 9.2, 9.3, 10.3, 10.4, 10.5, 10.8, 10.9 and 11.2 incl. Corr. 1: 2008
IEC 60945 Ed.3.0: 1996, clauses 10.2 and 10.3

(title and/or number and date of issue of the standard(s) or other normative document(s))

For assessment, see

- EMC Test Report FLI 12-14-082 and FLI 12-14-083, October 29, 2014 prepared by Furuno Labotech International Co., Ltd.

This declaration is issued according to the Directive 2014/30/EU of the European Parliament and of the Council of 26 February 2014 on the harmonisation of the laws of the Member States relating to electromagnetic compatibility.

On behalf of Furuno Electric Co., Ltd.

Yoshitaka Shogaki
Department General Manager
Quality Assurance Department

Nishinomiya City, Japan
April 20, 2016

(Place and date of issue)

(name and signature or equivalent marking of authorized person)