

 **FURUNO**

**MARINE VHF
RADIOTELEPHONE**

OWNER'S MANUAL

model **FM-2510**

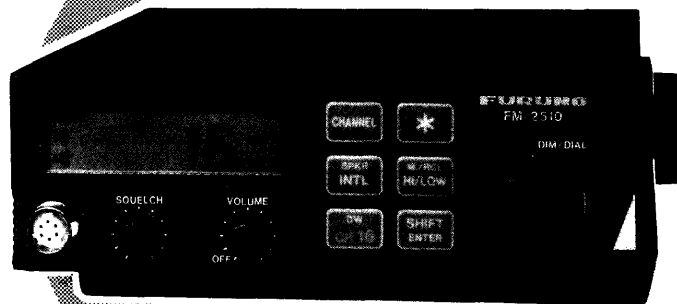

© FURUNO ELECTRIC CO., LTD.

9-52, Ashihara-cho,
Nishinomiya, Japan

Telephone: 0798-65-2111

Cable: FURUNO NISHINOMIYA

Telex: 5644-325/326 FURUNO J

Telefax: 0798-65-4200 (GIII)

All rights reserved.

Printed in Japan

PUB. No. OME-54810-L

(ETMI)

FM-2510

- Your Local Agent/Dealer

Initial Version: July, 1987

Version L: Mar. 8, 1996





SAFETY INSTRUCTIONS

"**DANGER**", "**WARNING**" and "**CAUTION**" notices appear throughout this manual. It is the responsibility of the operator and installer of the equipment to read, understand and follow these notices. If you have any questions regarding these safety instructions, please contact a FURUNO agent or dealer.



DANGER

This notice indicates a potentially hazardous situation which, if not avoided, will result in death or serious injury.



WARNING

This notice indicates a potentially hazardous situation which, if not avoided, could result in death or serious injury.



CAUTION

This notice indicates a potentially hazardous situation which, if not avoided, could result in minor or moderate injury, or property damage.



SAFETY INFORMATION FOR THE OPERATOR

WARNING



Do not open the cover of the equipment.

This equipment uses high voltage electricity which can shock, burn. Only qualified personnel should work inside the equipment.

Do not disassemble or modify the equipment.

Fire, electrical shock or serious injury can result.

Immediately turn off the power at the ship's mains switchboard if water or foreign object falls into the equipment or the equipment is emitting smoke or fire.

Continued use of the equipment can cause fire, electrical shock or serious injury.

CAUTION

Do not place liquid-filled containers on the top of the equipment.

Fire or electrical shock can result if a liquid spills into the equipment.

Do not place heater near the equipment.

Heat can melt the power cord, which can result in fire or electrical shock.

Do not operate the unit with wet hands.

Electrical shock can result.

Use the correct fuse.

Use of the wrong fuse can cause fire or equipment damage.



SAFETY INFORMATION FOR THE INSTALLER



WARNING



Only qualified personnel should work inside the equipment.

This equipment uses high voltage electricity which can shock, burn, or cause death.

Turn off the power at the ship's mains switchboard before beginning the installation. Post a warning sign near the switchboard to ensure that the power will not be applied while the equipment is being installed.

Serious injury or death can result if the power is not turned off, or is applied while the equipment is being installed.



CAUTION



Ground the equipment.

Ungrounded equipment can give off or receive electromagnetic interference or cause electrical shock.

Confirm that the power supply voltage is compatible with the voltage rating of the equipment.

Connection to the wrong power supply can cause fire or equipment damage. The voltage rating appears on the label at the rear of the equipment.

A WORD TO FM-2510 OWNERS

Congratulations on your choice of the Furuno FM-2510 MARINE VHF RADIOTELEPHONE ! We are confident that you will enjoy many years of trouble-free operation with this fine piece of equipment.

For over 40 years Furuno Electric Company has enjoyed an enviable reputation for quality and reliability throughout the world. This dedication is furthered by our extensive global network of agents and dealers.

Your FM-2510 is designed and constructed to provide commercial grade performance and reliability, yet affordable for pleasure craft owners.

Please carefully read this owner's manual and follow the recommended procedure for installation, operation and maintenance. With proper care, Your FM-2510 should provide years of enjoyable and dependable communications.

Thank you for considering and purchasing Furuno product.

FEATURES

- 25W RF output from an ultra-compact and solid cast-aluminum cabinet : may be mounted in any small space.
- Perfect interference rejection and minimum receiver distortion with the newest GaAs FET mixer.
- Pre-programmed with all international marine channels. Where permitted, USA channels, weather channels, and private channels are also programmed.
- 10 user-programmable channels with a back-up facility.
- Auto scan where authorized by the administrations.
- Dual watch for channel 16 and another channel.
- Large high-contrast LCD display with a dimmerable backlight facility ; easy-to-read for day and night.
- Advanced commercial grade design and components

C O N T E N T S

	Page
SPECIFICATIONS	1 to 5
INSTALLATION	6 to 12
GENERAL NOTES ON INSTALLATION	6
MOUNTING TRANSCEIVER	7
CABLE CONNECTIONS	9
OPERATION	13 to 28
OPERATING CONTROLS AND DISPLAY	13
RECEIVING	17
TRANSMITTING	20
SCANNING	23
DUAL WATCH	25
MEMORY CHANNEL OPERATION	26
GENERAL KNOWLEDGE ON OPERATING MARINE VHF	29 to 32
RULES AND MANNERS	29

CHANNEL USAGE	31
COMMUNICATION RANGE	32
MAINTENANCE	33 to 34
CLEANING	33
ANTENNA SYSTEM CHECK	34
BATTERY CHECK	34
FUSE REPLACEMENT	34
TROUBLESHOOTING	35 to 38
MINOR TROUBLESHOOTING	35
DISPLAY TEST	38
PARTS LIST/EXPLODED VIEW	39
BLOCK DIAGRAM	40
SCHEMATIC DIAGRAM	41
MARINE VHF CHANNELS (INTERNATIONAL VERSION)	43
MARINE VHF CHANNELS (USA VERSION)	44
MEMORY CHANNEL LIST	45
EXAMPLE RADIO LOG	46
DISTRESS CALLING PROCEDURE	48

SPECIFICATIONS

GENERAL

Rules :	FCC, CEPT, ITU and other national regulations		
Communication System :	Simplex or semi-duplex		
Class of Emission :	Frequency modulation with a preemphasis of 6dB/oct (Phase modulation)		
Channel Program :	International channels, US channels, Weather channels, Auto scan, Dual watch		
US version	International channels, Dual watch		
International version	Function of US or International version plus limited private channels according to authorization		
Special Version	25kHz		
Channel Spacing :	$\pm 1.5\text{kHz}$ (-20°C to $+55^{\circ}\text{C}$)		
Frequency Stability :	-20°C to $+60^{\circ}\text{C}$		
Operating Temperature Range :	50 ohms		
Antenna Impedance :	12VDC $+30\%$ / -10%		
Power Supply :	Stand-by	Receive	Transmit
Current Drain :	0.3A	0.5A	5.5A
Dimensions and Weight :	135 (W) x 45 (H) x 170 (D) mm,		0.95 kg
	5.34" (W) x 1.78" (H) x 6.72" (D),		4.6 lb
Memory Backup Period :	More than 3 years		
Compass Safe Distance :	Standard --- 0.4m		Steering --- 0.6m

RECEIVER

Frequency Range :	155.500MHz to 163.425MHz
Receiving System :	Double superheterodyne
Intermediate Frequency :	1st. 16.9MHz 2nd. 455kHz
Sensitivity :	Less than -6dBu ($0.5\mu\text{V}$) for 12dB SINAD
Selectivity :	70dB
Spurious Response Rejection :	-70dB
Intermodulation :	70dB
Squelch Sensitivity :	Threshold ; -8dBu ($0.4\mu\text{V}$) Tight ; 1dBu ($1.1\mu\text{V}$)
Audio Output :	Internal ; 0.5W into 8-ohm speaker External ; 4W into 4-ohm speaker
Harmonic Distortion :	Less than 10%



TRANSMITTER

Frequency Range :	155.500MHz to 158.825MHz
RF Output Power :	25W (HI), 1W (LOW) switchable Automatic power reduction on some specific channels as required by regulations
Frequency Deviation :	±5kHz max.
Spurious Emissions :	Atten. more than 70dB (FCC rule) Less than 2.5uW (CEPT rule)
Harmonic Emissions :	70dB below carrier level
Modulation AF Response :	Modulation index within +1dB or -3dB relative to its value at 1000Hz for modulation frequencies 300 to 3000Hz
Audio Frequency Distortion :	Less than 10% for ±3kHz deviation (at 1000Hz)

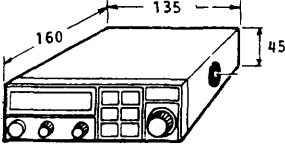
COMPLETE SET

NO	NAME	TYPE	CODE	Q'TY	1
1	Transceiver Unit	FM - 2510	005 - 371 - 000	1	
2	Accessories	FM - 2510F	See separate lists below.	1 set	
3	Spare Parts	FM - 2510S		1 set	
4	Installation Materials	FM - 2510C		1 set	

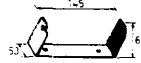
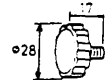
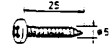
ACCESSORIES

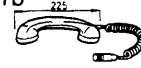
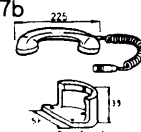
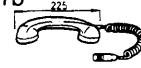
NO	NAME	TYPE	CODE	Q'TY	1	2.3.4
1	Hanger Bracket	FP05 - 01301	005 - 368 - 030	1		
2	Knob Screw	05 - 024 - 0124	100 - 076 - 110	2 sets		
3	Knob Washer	05 - 024 - 0123	100 - 076 - 100		2	
4	Nylon Washer	TM - 137 No.6	000 - 801 - 575			
5	Tapping Screw	5x25 SUS304	000 - 867 - 553	2		
6	Flat Washer	M5 SUS304	000 - 864 - 128			
7a	Microphone (General)	DM1620FZ1	000 - 112 - 622	1		
7b	Handset (Europe) & Hanger Kit	HS - 6000FZ5	000 - 112 - 623	1		
		FP05 - 01311	005 - 011 - 950	2		
7c	Noise Canceller Mic.	M112D4509910	000 - 113 - 344	1		

SPECIFICATIONS

SPARE PARTS

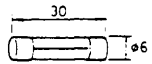
NO	NAME	TYPE	CODE	Q'TY	1
1	Fuse	FGBO10A125Vac	000-549-065	2	

INSTALLATION MATERIALS

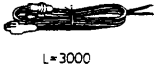
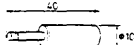
NO	NAME	TYPE	CODE	Q'TY	1	2
1	Power Cable	05S0388	000-111-061	1		
2	US Plug (ext. spkr)	PJ-2240-P	000-110-961	1		

OPTION

NO	NAME	TYPE	CODE	REMARKS
1	Whip Antenna	150M-W2VN	000-113-498	w/bracket
2	Coaxial Cable	5D-2V (White Sheath)	000-111-063	10 meter long
			000-111-064	20 meter long
3	Rectifier	PR-101	000-053-754	IN : 110/220Vac, OUT : 13.8Vdc
4	DC-DC Converter	PC-208	000-053-761	IN : 24Vdc, OUT : 12Vdc
5	External Speaker	HCB100D	000-113-352	4 ohms, 4W
6	Microphone	DM1620FZ2	000-113-500	w/15m cable
7	Coaxial Plug	OP05-13 (MP5)	005-371-440	2 pcs/set

SPECIFICATIONS

INSTALLATION

GENERAL NOTES ON INSTALLATION

Any radio equipment can provide its intended performance only when it is installed properly. Prior to starting installation, the following precautions should be kept in mind.

AVOID WATER SPRAY

Though the FM-2510 is splash-proof, it is not designed to be used outside the cabin, directly exposed to the environment! Salt water spray should be avoided.

CAUTION

Furuno will assure no responsibility for the damage caused by the continued exposure to the salt water spray.

AVOID SHOCK OR VIBRATION

The FM-2510 is designed to withstand possible shocks and vibrations normally experienced on small boats. However, excessive and continued shock and vibration can shorten the life of the equipment. Where necessary, appropriate shock absorption measures should be taken.

AVOID HOT ENVIRONMENT

Even though the LCD used on the FM-2510 is quite legible in the sunlight, it is requested to keep the transceiver out of the direct sunlight or at least shaded because of the heat that can build up in the cabinet.

The cabinet of the transceiver, especially the rear panel, gets warm after a long transmission. It is requested to provide some space around the transceiver to allow good air circulation.

AVOID ONBOARD NOISE

Though the FM-2510 is well shielded with cast-aluminum cabinet, it is requested to install the transceiver away from radio and navigation equipments, such as SSB/CB radiotelephone, direction finder or Loran receiver to avoid mutual interferences.

MOUNTING TRANSCEIVER

The FM-2510 can be mounted on overhead, tabletop or bulkhead with an optimum viewing angle by using the hanger bracket supplied. The hanger should be installed adequately to minimize wave shock and engine vibration. If necessary, reinforce the mounting location by lining block or doubling plate.

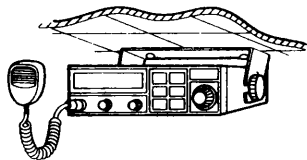

OVERHEAD
(DASHBOARD)

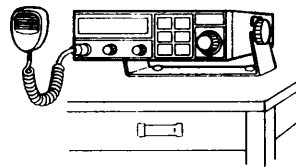

TABLETOP

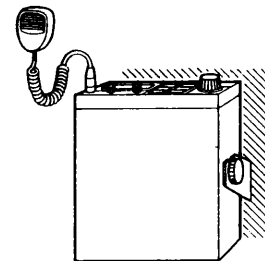

BULKHEAD

MOUNTING PROCEDURE

1. Drill two pilot holes for the hanger bracket.
2. Fix the hanger with the woodscrews supplied.

For thin walls, use bolts and nuts instead of the woodscrews.

3. Mount the transceiver unit on the hanger and tighten the knob screws at an adequate viewing angle.

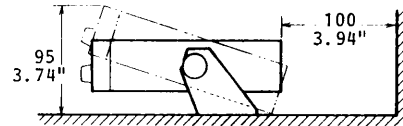
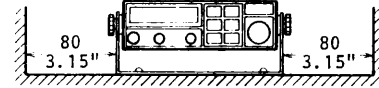
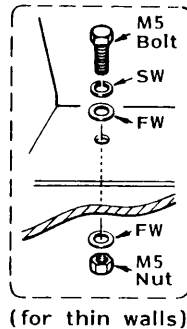
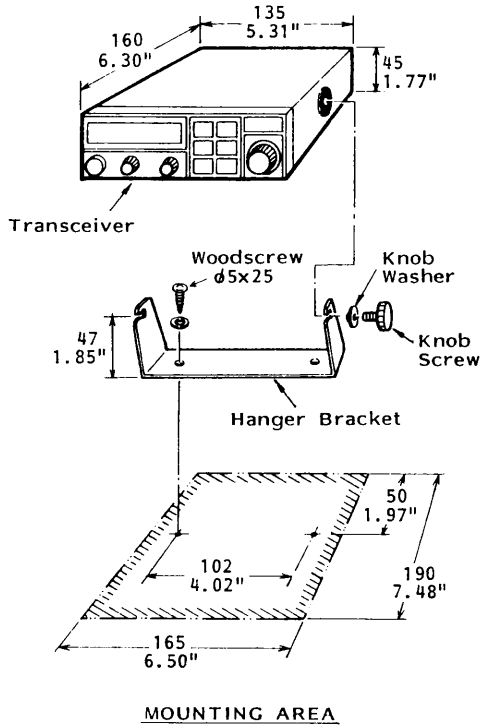

CLEARANCE

CABLE CONNECTIONS

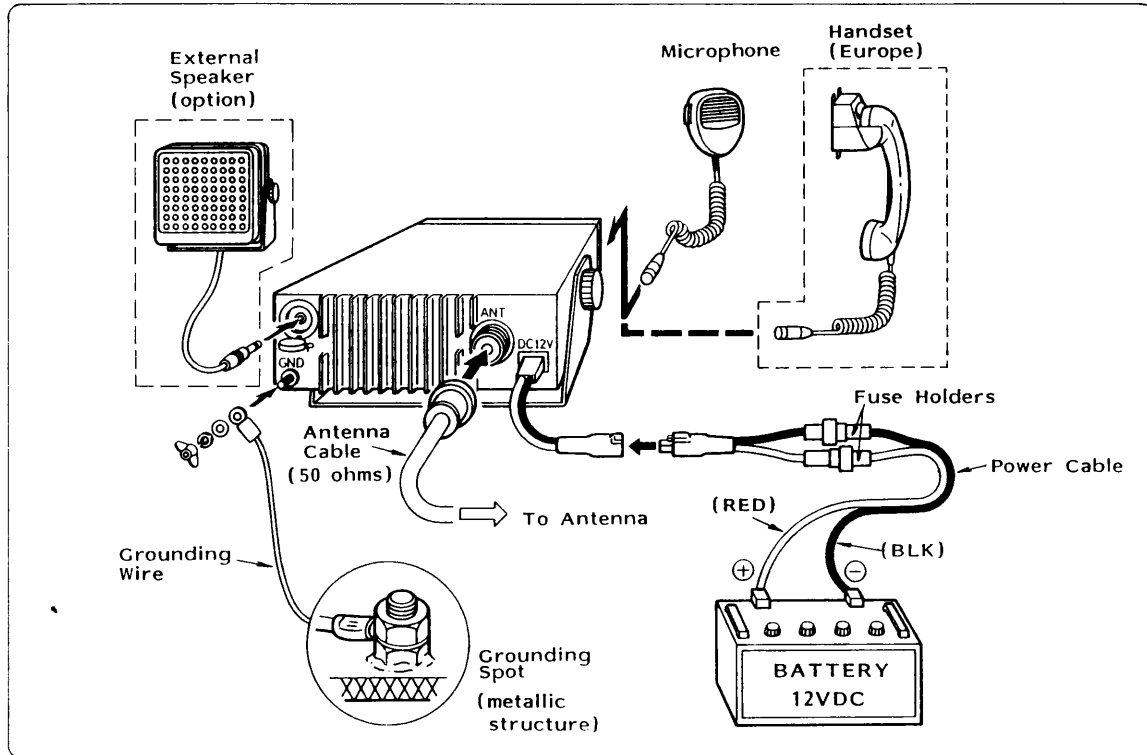

POWER CONNECTION

The FM-2510 is designed to operate from 12Vdc power supply. For 24Vdc or ac mains, use the separate DC-DC converter or rectifier respectively.

A 3 meter (10') cable, fitted with two snap-in fuse holders, is provided. Connect the wire ends to battery, distribution box or said unit; the red lead to positive (+) terminal and the black lead to negative (-) terminal. Refer to the illustration on page 7. Make sure to leave some wire behind the transceiver to gain easy access to the fuse holders.

If it is necessary to extend the power cable, use a heavy wire depending on the extension distance. Refer to the guideline below.

LENGTH	US GAUGE (AWG)	BRITISH GAUGE
5m (17')	14	16
10m (33')	10	12
20m (66')	8	10

Lighter wire will spoil the performance of the transceiver, or even cause fire in the worst case. Do not twist-wrap the joints but solder or use screw terminal when splicing the extension cable, and ensure all connections are tight, clean and well insulated.

ANTENNA CONNECTION

The antenna is the most important item to obtain the expected performance of your FM-2510. Provide a location as high and clear as possible, free from the influence of nearby antenna, rigging and masts.

The optional antenna supplied from Furuno is a $5/8 \lambda$ whip (1.2 meter or 4') containing a matching network in its base.

Any good quality antenna, complying with the following requirements, may be arranged locally. A high-gain antenna is most preferable. If you are not sure, consult with your dealer for the most suitable one.

- Frequency Range : 155MHz to 164MHz
- Impedance : 50 ohms
- Polarization : Vertical
- Handling Power : 30W min.
- Quality : To be able to withstand against possible marine environment

Any 50 ohm coaxial cable heavier than 5D-2V (equivalent to RG-212/U) may be used for connection between the antenna and the transceiver. To extend the antenna cable longer than 20m (67'), use heavier coaxial cable, such as 8D-2V or RG-213/U, to minimize the power loss and signal attenuation through the cable. Make sure to leave some service loop behind the transceiver for future service and maintenance.

When the antenna cable is layed, solder the "M" type plug onto the cable end. See the illustrations below.

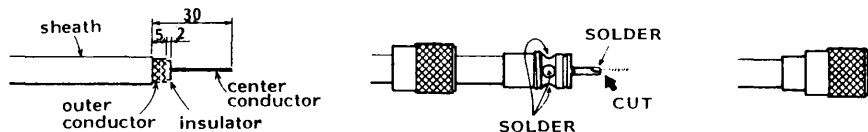

GROUND CONNECTION

To obtain maximum sensitivity of the receiver and to minimize mutual interference with the other equipments, the transceiver cabinet must be grounded properly to the ship's grounding bus. If grounding bus is not available, a good connection to the hull will be sufficient on a metallic boat. On a wooden or fibreglass boat, try to ground to the engine block. (Consult with a shipyard or service shop.)

EXTERNAL SPEAKER

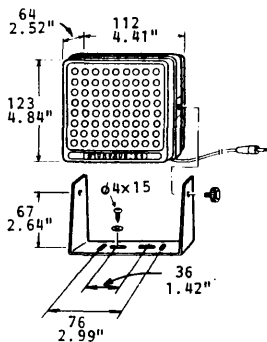

The FM-2510 has a built-in speaker suitable for most applications. However, if an external speaker is desired, connect the optional external speaker (4W/4 ohms) to the SPKR jack on the rear panel.

Note that the built-in speaker is disabled when the external speaker is plugged in.

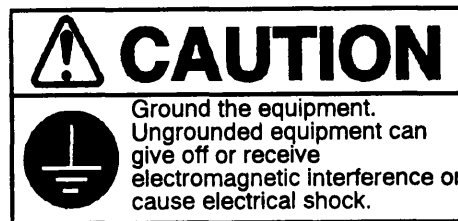

OPERATION

OPERATING CONTROLS

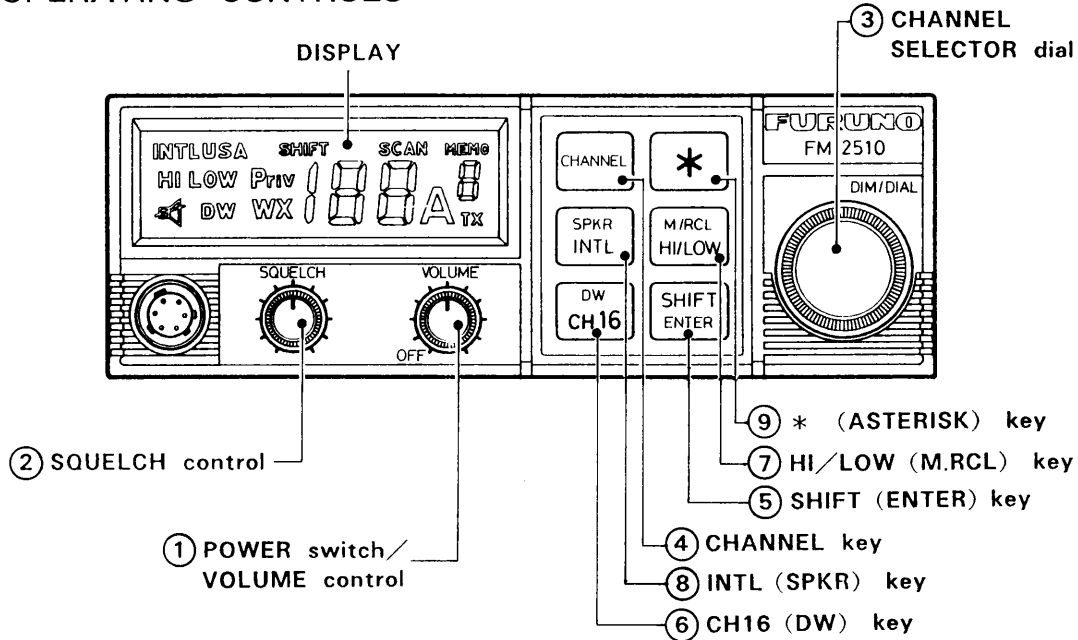

① **VOLUME control**
POWER switch



Changes the audio output level of the speaker in the receive mode.

Rotate the control clockwise to turn on the equipment. Turn it fully counterclockwise, beyond click, to switch off the power.

② **SQUELCH control**



Changes the squelch threshold level to allow quiet reception when no signal is present. Set it correctly to permit reliable scan watch and dual watch operations.

③ **CHANNEL SELECTOR dial**
(DIM control)



Selects a channel within a group. Rotating it clockwise increments the channel or memo number, and vice versa.

Also changes the display illumination brightness, when used together with the SHIFT (ENTER) key.

④ **CHANNEL key**



Recalls the ordinary marine channel mode ; INTL or USA. Pressing for more than one second provides auto scan mode (depends on authorization).

⑤ **SHIFT (ENTER) key**



Activates the secondary function of each dual-function key on the front panel. Press this key prior to selecting a secondary function.

Also acts as enter key in the memory channel store mode.

⑥ **CH16 (DW)** key



Primary : Selects the channel 16 instantly.

Secondary : Activates the dual watch function when pressed after SHIFT (ENTER) key is pressed.

⑦ **HI/LOW (M.RCL)** key



Primary : Alternates between high power (25W) and low power (1W) of the transmitter.

Secondary : Recalls user memory channel mode. Pressing for more than one second provides auto scan for all memory channels.

⑧ **INTL (SPKR)** key



Primary : Alternates between the international and USA channel assignment.

Secondary : Turns on and off the built-in speaker. The handset speaker is enabled only when the built-in speaker is off. (Opposite state)

⑨ * **Asterisk** key



Primary : Recalls weather channel mode. Pressing for more than one second provides auto scan for all weather channels,

Secondary : Recalls private channel mode. (Private channels are not provided in the equipment for USA and some other countries, thus, no response to the key operation.)

STATUS INDICATORS

1. **INTL and USA** Alternatively indicates the channel assignment ; international or USA. (US version only)
2. **HI and LOW** Alternatively indicates the transmitter power ; high (25W) or low (1W).
3. **DW** Indicates that the receiver is in the dual watch mode.
4. **WX** Indicates that the receiver is in the weather channel mode. (US version only)
5. **Priv** Indicates that the transceiver is in the private channel mode (depends on authorization). This will not appear on the US version.
6. **TX** Indicates that the transmitter is activated.
7. **MEMO** Indicates that the transceiver is in the memory channel mode.
8.  **(SPEAKER OFF)** Indicates that the built-in speaker is disabled. The handset speaker is not affected by the speaker on/off selection.

RECEIVING

1. POWER ON



Turn on the VOLUME (POWER) control clockwise to 9 o'clock position. The channel number "16" will be presented on the display.

2. ADJUSTING DIMMER

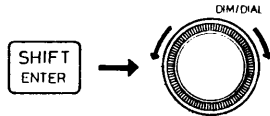

Hit the SHIFT (ENTER) key, and rotate the CHANNEL SELECTOR dial immediately. The illumination intensity for the display changes in four steps. Select an optimum brightness depending on the working environment. (The SHIFT mode will be cancelled automatically after the adjustment.)

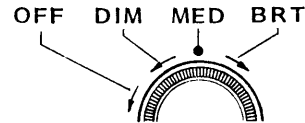

3. ADJUSTING VOLUME

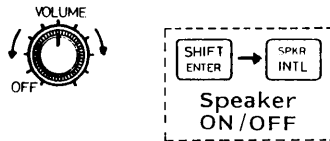

Turn the VOLUME control for an optimum sound level. If the "🔊" (speaker off mark) is present on the display, hit the SHIFT (ENTER) key and then INTL (SPKR) key in sequence to enable the built-in speaker.

(To monitor sound by the handset speaker, the built-in speaker must be disabled.)

4. ADJUSTING SQUELCH

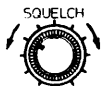

(Turn slowly.)

Turn the SQUELCH control slowly clockwise until the receiver noise just fades away. Perform this operation when no traffic is being received. Do not turn the SQUELCH too far clockwise. Otherwise, you will miss weak incoming signal.

NOTE

To obtain correct scan watch/dual watch response, adjust the SQUELCH control precisely.

5. SELECTING INTERNATIONAL OR USA

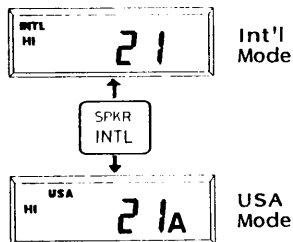

The channel assignment after power-on is always in the international (INTL) mode. To work in the US waters, hit the INTL (SPKR) key once. The "USA" mark will appear instead of "INTL." To return to the international mode, hit the INTL (SPKR) key again.

(The USA mode is available only on US version.)

6. SELECTING MARINE CHANNEL

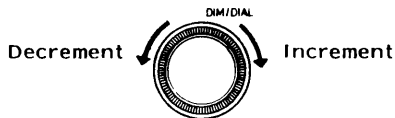

Rotate the CHANNEL SELECTOR for the desired channel number. A clockwise rotation increments the channel number, and vice versa.

7. SELECTING WEATHER CHANNEL

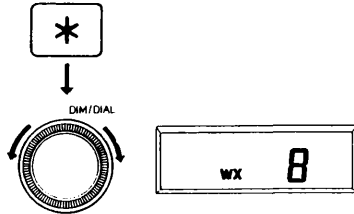

- 1) Press the * key. The "WX" mark and a previously accessed weather channel will be displayed.
- 2) As necessary, rotate the CHANNEL SELECTOR dial for the desired weather channel number.
(The weather channels are available only on US version.)

To return to ordinary marine channel, press the CHANNEL key.

8. SELECTING MEMORY CHANNEL

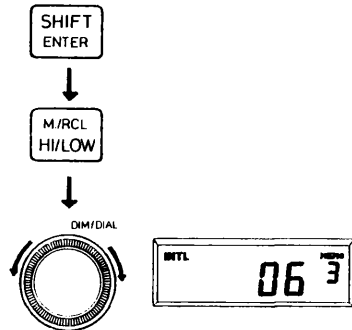

Prior to selecting the memory channel, store your desired channels into the memory. (Refer to page 26 for storing the memory channels.)

- 1) Hit the SHIFT key. The "SHIFT" mark appears on the display to prompt you to specify the secondary function.
- 2) Hit the HI/LOW (M.RCL) key. The "MEMO" mark and a previously accessed memo number and the channel number appear on the display.
- 3) Rotate the CHANNEL SELECTOR dial for the desired channel number.

To return to ordinary marine channel, press the CHANNEL key.

TRANSMITTING

1. SELECTING TRANSMITTER POWER

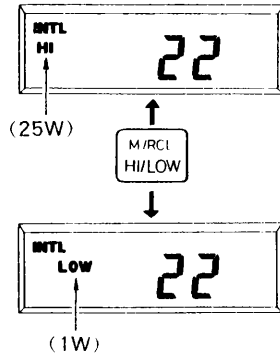

M/RCL
HI/LOW

Hold on to use
high power on
channels 13 & 67.

After power-on, the transmitter is automatically set to "HI" (25W) output power. (except on CH13 and 67 in USA version). If desired, hit the HI-LOW (M.RCL) key to select low power (1W). The "LOW" mark appears instead of "HI."

Transmission at low output power is recommended for short range communications or in harbor areas to minimize interference to the others. Otherwise, use high power for reliable communications.

To return to the high power mode, hit the HI/LOW (M.RCL) key again.

NOTE

As requested by the regulations, the transmitter power is automatically set to low when one of the following channels is selected.

INTL : CH15 CH17 **USA :** CH13 CH17 CH67

In the USA/Canada version, output power is normally below 1W. However, manual override is possible to obtain the high power. Keep pressed the HI/LOW (M.RCL) key to send speech at high power on said channels.

2. CHECKING OPERATING CHANNEL

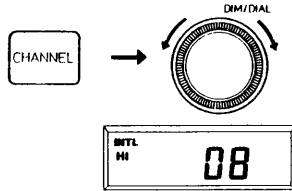

- 1) If you are on a weather or memory channel, hit the CHANNEL key to return to the ordinary marine channel mode; INTL or USA. This step can be omitted if you are already on ordinary channel.
- 2) Rotate the CHANNEL SELECTOR dial for the channel you want to use, and listen carefully to confirm that the channel is open.

3. CALLING ON CHANNEL 16

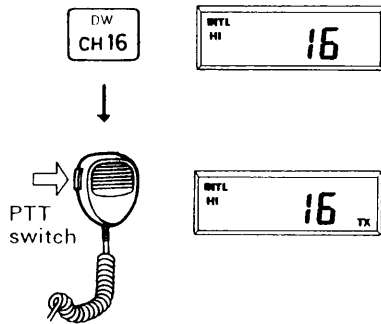

- 1) Hit the CH16 (DW) key to select CH16 immediately. Confirm that the channel is not busy before commencing transmission.
- 2) Pick up the microphone (or handset), press the PTT (press-to-talk) switch and then call the one you want to make contact. Hold the microphone fairly close to your mouth and speak clearly.

Press the PTT switch to talk and release it to listen for the response.

IMPORTANT

CH16 is important for distress and calling. Remember to keep the communications as short as possible to give way to the others.

4. SWITCHING TO WORKING CHANNEL

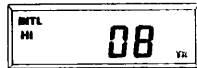
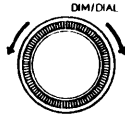

When contact is established on channel 16, turn the CHANNEL SELECTOR dial to the working channel as instructed by the coastal station operator.

Press the PTT switch to talk and release it to listen for the response.

SCANNING

The auto scan watch is the function where the receiver automatically scans channels upward every 0.15 seconds. If any signal is detected, the receiver will lock on that channel. In 5 seconds after the signal has gone, the receiver reverts to scanning again.

To allow scan watch in correct manner, the SQUELCH control must be adjusted precisely, because the scan/lock judgement is done by detecting the squelch status.

NOTE

Scanning function is not available in all units, but only available where permitted by the Administrations.

1. START SCANNING

Use one of the following key sequence, depending on the channel group you want to scan.

A Ordinary Marine Channels



(Hold 1 sec.)

Press and hold the CHANNEL key for more than one second until the SCAN mark appears on the display.

B Weather Channels



(Hold 1 sec.)

Press and hold the * (asterisk) key for more than one second until the SCAN mark appears on the display.

C Memory Channels

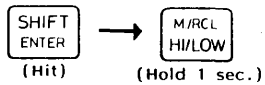

Hit the SHIFT (ENTER) key first, and then hold the HI/LOW (M.RCL) key for more than one second until the SCAN mark appears on the display.

D Private Channels

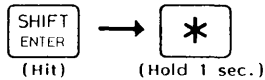

Hit the SHIFT (ENTER) key first, and then hold the * (asterisk) key for more than one second until the SCAN mark appears on the display.

2. STOP SCANNING

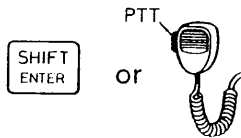

To terminate the scan mode, hit the SHIFT (ENTER) key. It is also possible to stop scanning by pressing the PTT switch on the microphone or handset. The receiver will stop on the channel being received at the moment you press the key.

DUAL WATCH

In the dual watch mode, a desired channel and the calling/distress channel (CH16) are received alternately (1 second for the desired channel and 0.15 second for channel 16). If any signal is present on channel 16, the receiver locks on channel 16 and ignore the reception on the other channel. In 5 seconds after the signal on channel 16 has gone, the receiver reverts to dual watching again.

To allow dual watch in correct manner, adjust the SQUELCH control precisely.

1. SELECTING DESIRED CHANNEL

Select a desired channel. The channel can be ordinary marine channel, weather channel, private channel or memory channel. Refer to "RECEIVING" section.

2. STARTING DUAL WATCH



Hit the SHIFT key first, and then the CH16 (DW) key in sequence. The "DW" mark appears, and the channel display will start alternating between the two channels.

3. STOPPING DUAL WATCH

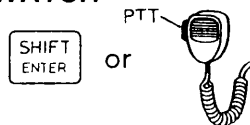

To terminate the dual watch function, hit the SHIFT key. It is also possible to stop dual watching by pressing the PTT switch on the microphone or handset. The receiver will stop on the channel selected in the above step 1.

MEMORY CHANNEL OPERATION

The memory channel function provides quick selection of upto 10 most used channels (ordinary, private, weather channels). Scanning within the memory channel is also available.

STORING CHANNELS

1. SETTING MEMORY NUMBER

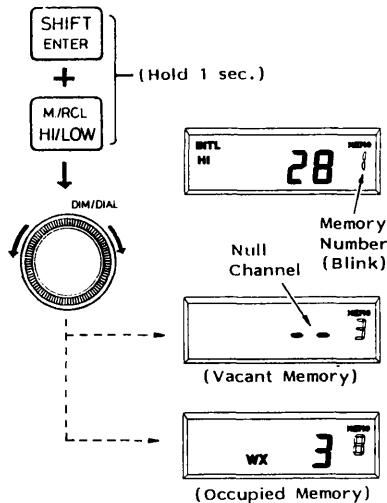

1) While holding down the SHIFT (ENTER) key, press and hold the HI/LOW (M.RCL) key for more than one second. The memo number should start blinking.

2) Rotate the CHANNEL SELECTOR dial for the desired memory number (0 to 9).

If the memory is vacant, the "—" (null channel mark) will be displayed instead of a channel number. Select a vacant memory to store new channel.

If some channel has already been stored in that memory, the channel number will be displayed. Stored memory may be selected to correct the memory contents or overwrite new channel.

2. SETTING CHANNEL NUMBER

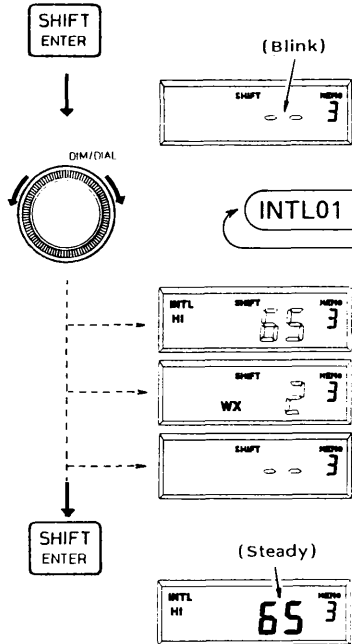

- 1) Hit the SHIFT (ENTER) key once. The "SHFT" mark appears, and now the channel number starts blinking.
- 2) Rotate the CHANNEL SELECTOR dial for the desired channel number.

As turning the dial, all possible channel numbers are displayed one by one as shown below. (Note that the callable channel groups are determined by the specifications.)

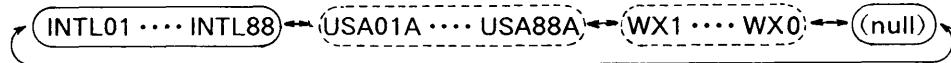

To set international channel 65, call "INTL 65" on the display.



To set weather channel 2, call "WX 2" on the display.

To clear the memory contents, select "--" (null channel).

- 3) When the desired channel number is selected, hit the SHIFT (ENTER) key once again to terminate the store sequence. The channel number should cease blinking.

To store another channel, repeat the whole steps 1 and 2 above.

MEMORY CHANNEL LIST

MEMO NO	Stored Channel No.		Purpose/Remark
0		22A	U.S.C.G
1		1	PORTLAND (ORE)
2		26	KOE 815

When the programming is completed, make a note on the "MEMORY CHANNEL LIST" on page 45 for your future reference.

The contents of memory will be preserved even when the power is turned off.

RECALLING MEMORY CHANNELS

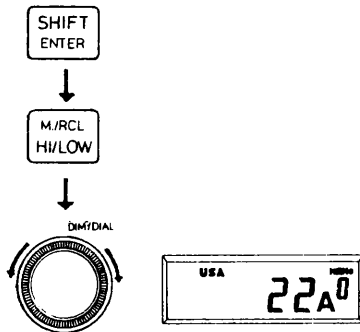

Hit the SHIFT (ENTER) key and then HI/LOW (M.RCL) key in sequence.

Rotate the CHANNEL SELECTOR dial for your desired memory number.

GENERAL KNOWLEDGE ON OPERATING MARINE VHF

RULES AND MANNERS

The FM-2510 fully complies with requirements for international maritime VHF radio service. And it is intended to be used by a person who holds valid radio operator license and station call sign.

Followings are some important rules, regulations and manners on operating the equipment.

- Whenever the radio is turned on, keep watch on channel 16 for distress or calling message.
- Distress communications have absolute priority. If you hear a MAYDAY, talk only if you can help, and be prepared to offer assistance or relay the distress message.
- Listen before transmitting to avoid interfering with other communications.
- The ship Radiotelephones Station licensee is responsible for recording in a communication log all contacts made over the radiotelephone and watch period on channel 16. All distress, emergency and safety messages must be recorded in detail. Entries must show boat's name, call sign, watch start/stop times, and operator's signature. Use 24-hour notation to record time.

- Radio wave is public property, keep all communications as brief and clear as possible.
- Declare ID or call sign at the beginning and end of each communication.
- Use appropriate channel for the purpose of communication. (Refer to CHANNEL USAGE on the next page.)
- Do not divulge contents of communications nor use them for private benefit without permission. (This does not apply for distress communications.)
- Be aware that many people is listening. Do not use indecent or profane language.

CHANNEL USAGE

The Equipment contains all the channels assigned for maritime VHF service. However, each channel is intended to be used for particular purpose (s). The following shows common usage for some important channels.

As purpose of some other channels are slightly different from country to country, operator is requested to study local channel assignment.

CH16DISTRESS, SAFETY and CALLING for Intership and Ship-to-coast

CH06 SAFETY for Intership only

CH08 General Intership

CH12/14..... PORT OPERATIONS for Intership and Ship-to-coast

CH20/22..... PORT OPERATIONS for Ship-to-coast (CH22 is simplex in USA mode, and is assigned for communications with U.S.C.G.)

CH77 Intership (In USA, limited for port operations : communications with pilots regarding the movement and docking of ships. The output power to be less than 1W.)

Refer also to channel/frequency list for general use of each channel. (pages 43 and 44)

GENERAL KNOWLEDGE

COMMUNICATION DISTANCE

The FM-2510 operates on VHF band assigned for maritime mobile stations. (156.5MHz to 163.0MHz)

VHF radio wave, unlike LF or HF, propagates like light ray. Thus, communication is available only with the one visible above the horizon, so called line-of-sight basis.

Under normal propagation conditions, however, refractive index of the atmosphere decreases with height so that radio waves travel more slowly near the seasurface than at higher altitude. That is, the radio wave is bent along the earth and reaches slightly beyond the geographical horizon.

Even if a clear line-of-sight condition is given, radio wave is attenuated through the signal path. The communication distance is limited also by transmitter power, antenna efficiency and receiver sensitivity.

It is practically known that average communication range, using 25W marine VHF, is 10 to 15 n.m. for ship-to-ship and 20 to 30 n.m. for ship-to-shore.

Note that the radio barrier in the signal path, such as big boat, crane, building or mountain, can destroy VHF communications even for short distance.

MAINTENANCE

The FM-2510 is designed to provide trouble-free operation for years. It is, however, recommended to inspect and maintain the following points to minimize possibility of a equipment failure and assure optimum performance. Be sure to disconnect the power cable at the fuse holders before maintenance work.

CLEANING

Transceiver : Keep the unit clean and dry all times. Dust or loose dirt accumulated on the front panel and knobs should be wiped off with a soft, dry cloth. Use mild detergent and water on a cotton tipped swab or soft cloth in stubborn case.

CAUTION

Never use plastic solvents, such as thinner or acetone for cleaning. It may dissolve paint coating/marking on the front panel and cabinet case.

Plugs : Check all plugs for dust or corrosion. If corroded, polish the contact and re-tighten securely.

ANTENNA SYSTEM CHECK

Since the antenna is exposed to direct sunshine and/or salt water spray, it is subject to corrosion or salt water immersion at the antenna basement. The physical damage, such as crack, may sometimes be expected on the element under severe ship's vibration. Should the trace of cracks or water immersion is found, contact your local authorized FURUNO dealer for servicing.

BATTERY CHECK

The FM-2510 operates normally at any voltage between 11 and 15Vdc. If the battery voltage is out of ratings, check the battery liquid or the charging system of your boat. Check also rust or corrosion at the battery terminals and ship's mains switch-board for poor contact.

FUSE REPLACEMENT

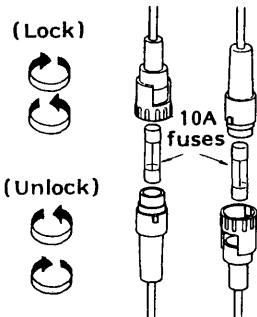

To prevent the transceiver from serious damage, two 10A fuses are provided in the snap-in fuse holders on the power cable. The fuse protects against overvoltage/reverse polarity of the ship's mains or internal fault of the equipment. If the fuse has blown, first find the cause of the problem before replacing it with new one.

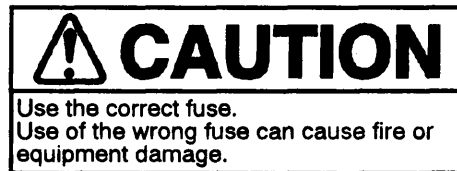

TROUBLESHOOTING

MINOR TROUBLESHOOTING

It is known that more than 50% of VHF troubles are raised not by the transceiver itself but by ANT/feeder or power supply system. The list below provides simple troubleshooting that can be done by the operator. DO NOT ATTEMPT TO CHECK INSIDE THE TRANSCEIVER. CARELESS HANDLING MAY CAUSE PERMANENT DAMAGE TO THE TRANSCEIVER.

Symptom	Possible Cause	Remedy
Nothing happens.	<ol style="list-style-type: none">1. Power is off at mains switchboard.2. Power lead is loose or pulled out.3. Mains battery is flat.4. Fuse has blown.	<ol style="list-style-type: none">1. Turn mains switch on.2. Secure plug firmly and check connections to battery.3. Check battery liquid, charging system, etc.4. Check mains voltage and polarity and then put 10 amp fuse.
LCD display looks normal but no sound at all	<ol style="list-style-type: none">1. Speaker is switched off.2. SQUELCH setting is too high. (Turned too much clockwise)3. VOLUME setting is too low.4. External speaker connection (rear panel) is improperly made.	<ol style="list-style-type: none">1. Hit [SHIFT] and [SPKR] keys in sequence.2,3. To confirm audio output, turn SQUELCH fully CCW and turn VOLUME slowly CW.4. Check external speaker connection.

Symptom	Possible Cause	Remedy
Noise but no or poor signal reception	<ol style="list-style-type: none"> 1. ANT connector (rear panel) is loose or pulled out. 2. Antenna is smashed off. 3. Antenna cable is damaged or immersed with water. 4. Radio barrier (big vessel, crane, mountain, etc.) in the signal path. 5. Transmitter is too far away or transmitting in low power. 	<ol style="list-style-type: none"> 1. Fasten antenna plug tightly. 2. Install new antenna vertically. 3. Lay new cable (50 ohm coaxial cable). 4.5 Line-of-sight is a rule for VHF communications.
"TX" mark appears but no or low output power.	1. Refer to items 1 thru 4 above.	<ol style="list-style-type: none"> 2. Set it to "HI". 3. INTL CH15, 17 and USA CH13, 17, 67 are low power channels.
	<ol style="list-style-type: none"> 2. POWER setting is "LOW". 3. The channel is to be operated in low power under regulation. ("LOW" mark should appear.) 	

Symptom	Possible Cause	Remedy
<p>"TX" mark won't come on with PTT switch pressed.</p>	<ol style="list-style-type: none"> 1. Attempting transmission on a channel assigned only for reception: CH15 (USA), WX0 thru WX9, etc. 2. Transceiver is in "DW" or in "SCAN" mode. 	<ol style="list-style-type: none"> 1. Refer to channel list. 2. Press [SHIFT] key to return to normal mode.
<p>Can't use private channel.</p>	<ol style="list-style-type: none"> 1. Private channels are not programmed. 	<ol style="list-style-type: none"> 1. Ask your dealer for channel preset. (authorization required)
<p>Won't scan normally on "DW" or "SCAN" mode. (locked on a channel)</p>	<ol style="list-style-type: none"> 1. SQUELCH setting too low causing noise all the time. 	<ol style="list-style-type: none"> 1. Adjust SQUELCH so that noise just fades out.
<p>Turned abnormally to channel 16.</p>	<ol style="list-style-type: none"> 1. Had short power failure. 	<ol style="list-style-type: none"> 1. Select desired channel and function again. Check power line connections.

DISPLAY TEST

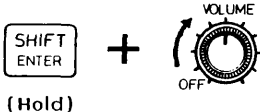

If the LCD display appears to be abnormal, conduct the LCD Display selftest. Press and hold the SHIFT key, then turn the power on. If the LCD display is normal, the test reading shown below is displayed for five seconds. The transceiver will then go into normal channel 16 reception. Watch the LCD carefully if there exists any missing segment.

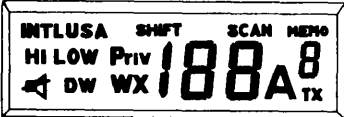

NO.	NAME	TYPE	CODE	REMARKS
1	Main Case Assy	05-024-0101		
2	Knob (S)	05-024-0104	100-075-910	VOLUME/SQUELCH
3	Knob (L)	05-024-0103	100-075-900	CHANNEL
4	Panel Board Assy	05P0245	005-371-410	
5	TX/RX Board Assy	05P0244	005-371-400	
6	Bottom Cover Assy	05-024-0102		
7	Speaker Assy	SI006517		8 ohms, 0.5W
8	Hanger Bracket	FP05-01301	005-368-030	
9	Knob Screw Assy	FP05-01302	005-368-040	

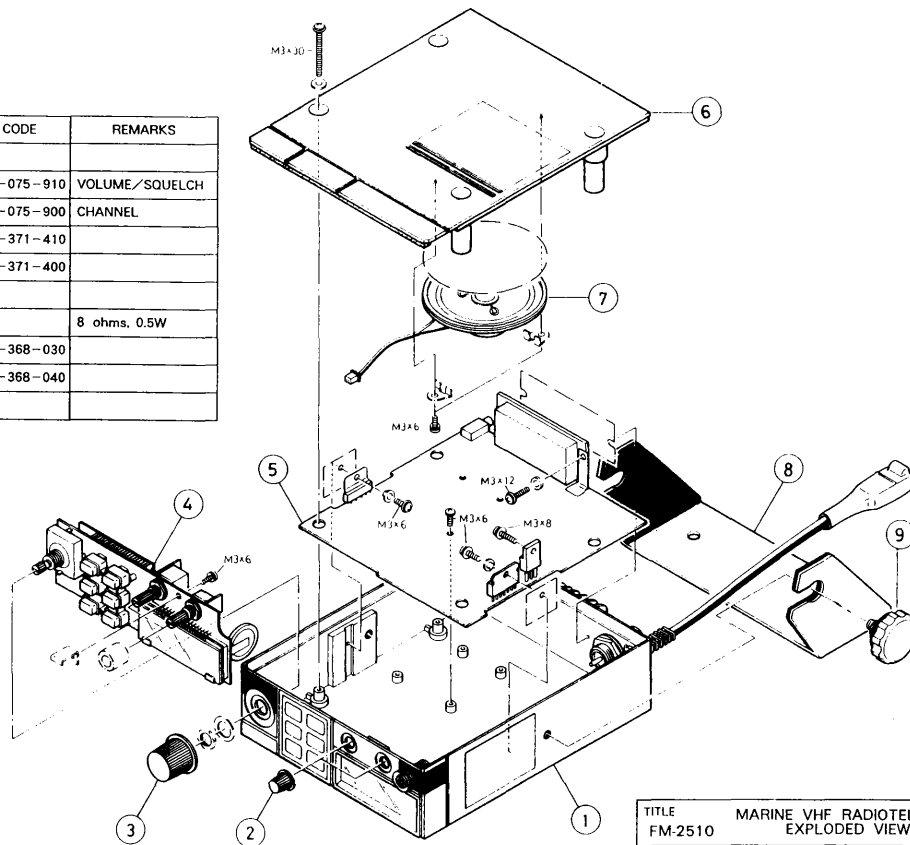

TITLE MARINE VHF RADIOTELEPHONE
 FM-2510 EXPLODED VIEW
 DWG. NO. E5481-006-B

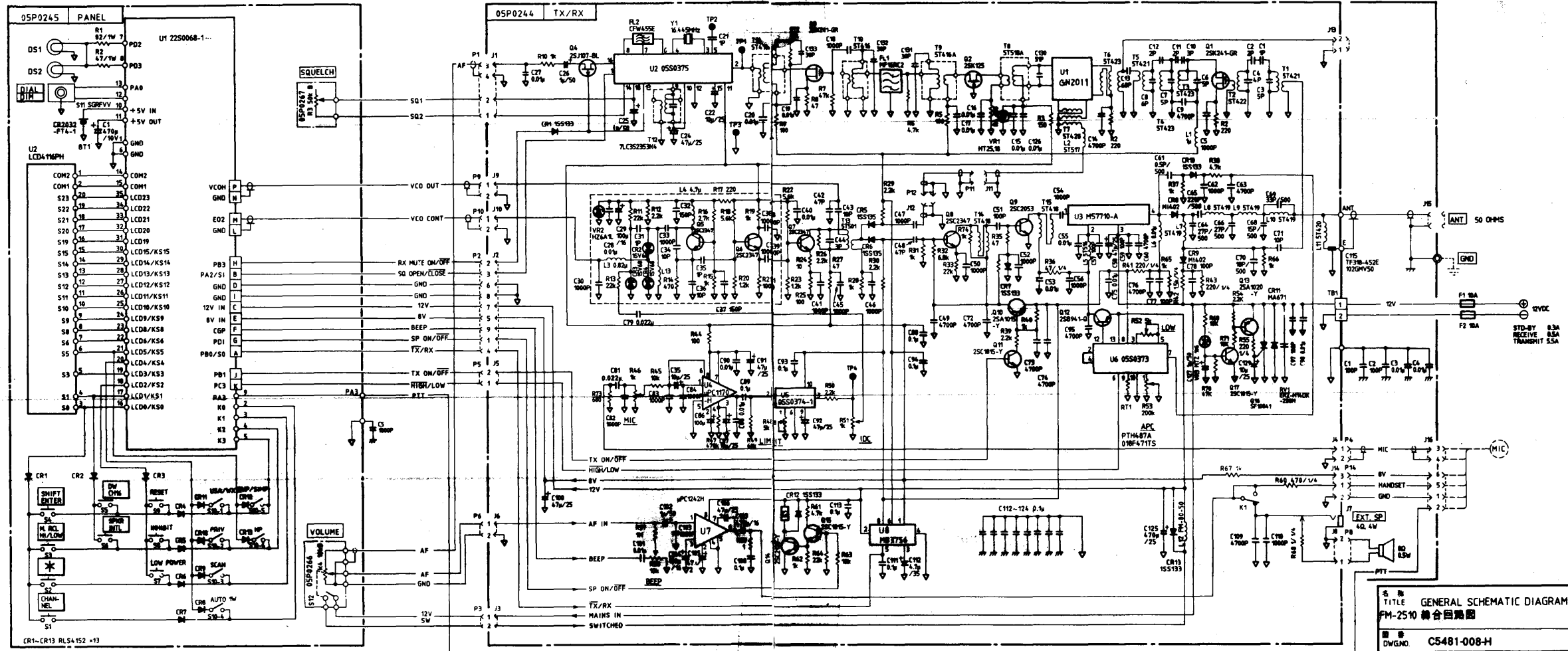

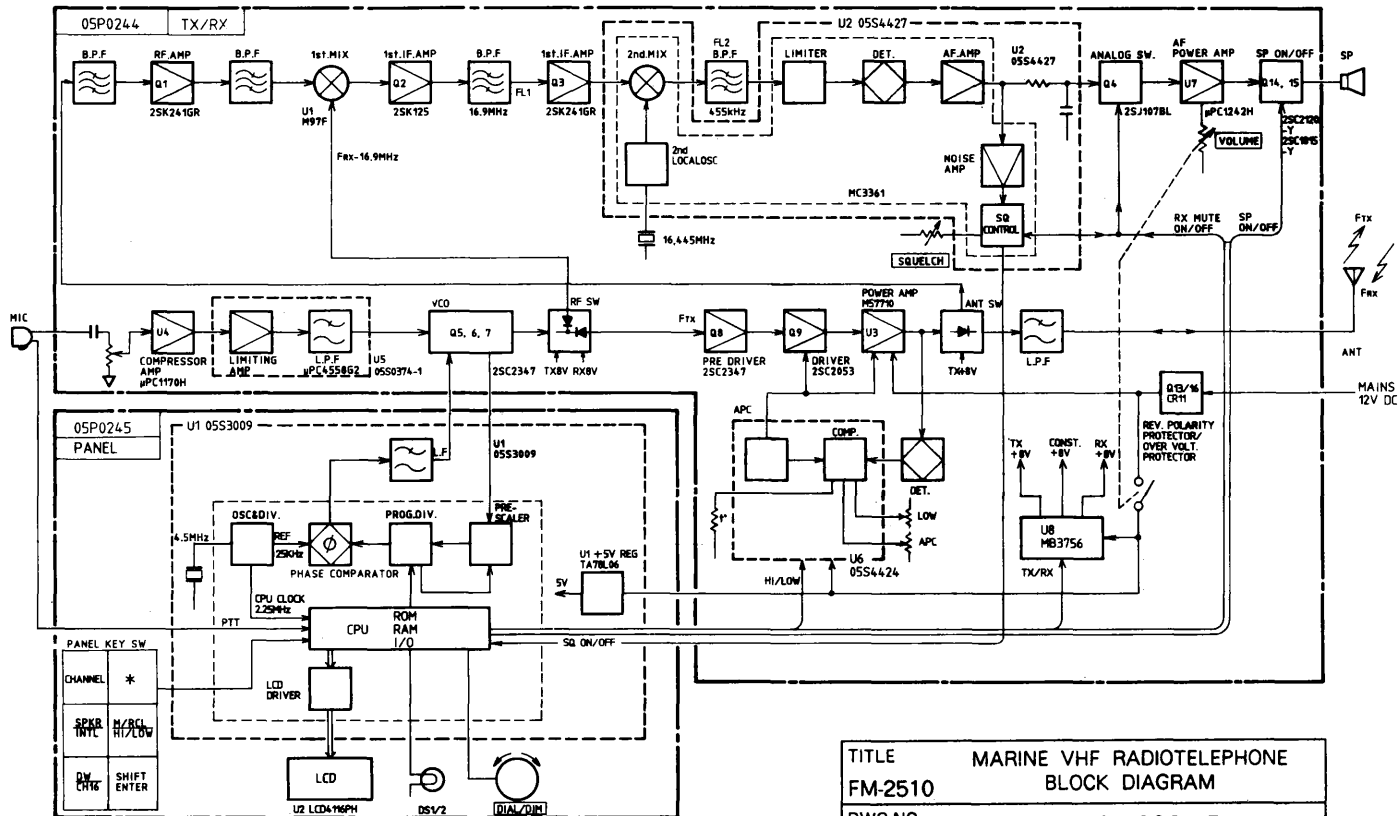

TITLE MARINE VHF RADIOTELEPHONE
 FM-2510
 BLOCK DIAGRAM
 DWG.NO. E5481-009-B

**MARINE VHF CHANNEL FREQUENCIES
(INTERNATIONAL VERSION)**

CH	Ship Tx	Ship Rx	Type of Operation	CH	Ship Tx	Ship Rx	Type of Operation
01	156.050	160.650	Public Correspondence, Port Operation	60	156.025	160.625	Public Correspondence, Port Operation
02	156.100	160.700	Public Correspondence, Port Operation	61	156.075	160.675	Public Correspondence, Port Operation
03	156.150	160.750	Public Correspondence, Port Operation	62	156.125	160.725	Public Correspondence, Port Operation
04	156.200	160.800	Public Correspondence, Port Operation	63	156.175	160.775	Public Correspondence, Port Operation
05	156.250	160.850	Public Correspondence, Port Operation	64	156.225	160.825	Public Correspondence, Port Operation
06	156.300	156.300	Safety	65	156.275	160.875	Public Correspondence, Port Operation
07	156.350	160.950	Public Correspondence, Port Operation	66	156.325	160.925	Public Correspondence, Port Operation
08	156.400	156.400	Inter Ship	67	156.375	156.375	Port Operation
09	156.450	156.450	Port Operation	68	156.425	156.425	Port Operation
10	156.500	156.500	Port Operation	69	156.475	156.475	Port Operation
11	156.550	156.550	Port Operation	70	156.525	156.525	Digital Selective Calling
12	156.600	156.600	Port Operation	71	156.575	156.575	Intership, Port Operation
13	156.650	156.650	Bridge-to-Bridge	72	156.625	156.625	Intership
14	156.700	156.700	Port Operation	73	156.675	156.675	Port Operation
15	156.750	156.750	Coast-to-Ship, 1W	74	156.725	156.725	Port Operation
16	156.800	156.800	Distress, Safety and Calling	77	156.875	156.875	Intership
17	156.850	156.850	State-controlled, Ship-to-coast, 1W	78	156.925	161.525	Port Operation
18	156.900	161.500	Port Operation	79	156.975	161.575	Port Operation
19	156.950	161.550	Port Operation	80	157.025	161.625	Port Operation
20	157.000	161.600	Port Operation	81	157.075	161.675	Port Operation
21	157.050	161.650	Port Operation	82	157.125	161.725	Port Operation, Public Correspondence
22	157.100	161.700	Port Operation	83	157.175	161.775	Public Correspondence
23	157.150	161.750	Public Correspondence	84	157.225	161.825	Port Operation, Public Correspondence
24	157.200	161.800	Public Correspondence	85	157.275	161.875	Port Operation
25	157.250	161.850	Public Correspondence	86	157.325	161.925	Port Operation
26	157.300	161.900	Public Correspondence	87	157.375	161.975	Port Operation
27	157.350	161.950	Public Correspondence	88	157.425	162.025	Port Operation
28	157.400	162.000	Public Correspondence				

MARINE VHF CHANNEL FREQUENCIES (USA VERSION)

CH	Ship Tx	Ship Rx	Type of Operation
01A	156.050	156.050	Port Operation, Commercial
02A	156.100	156.100	
03A	156.150	156.150	
04A	156.200	156.200	
05A	156.250	156.250	
06	156.300	156.300	Intership Safety
07A	156.350	156.350	Commercial
08	156.400	156.400	Commercial (Intership)
09	156.450	156.450	Commercial and Non-commercial
10	156.500	156.500	Commercial
11	156.550	156.550	Commercial
12	156.600	156.600	Port Operation
13	156.650	156.650	Bridge-to-Bridge, Navigational, 1W
14	156.700	156.700	Port Operation
15		156.750	Environmental (Receive only)
16	156.800	156.800	Distress, Safety and Calling
17	156.850	156.850	State-controlled, Ship-to-coast, 1W
18A	156.900	156.900	Commercial
19A	156.950	156.950	Commercial
20	157.000	161.600	Port Operation
21A	157.050	157.050	US Government
22A	157.100	157.100	Coast Guard Liaison
23A	157.150	157.150	US Government
24	157.200	161.800	Public Correspondence
25	157.250	161.850	Public Correspondence
26	157.300	161.900	Public Correspondence
27	157.350	161.950	Public Correspondence
28	157.400	162.000	Public Correspondence
60	156.025	160.625	
61	156.075	160.675	
62	156.125	160.725	
63A	156.175	156.175	Vessel Traffic Service
64	156.225	160.825	
65A	156.275	156.275	Port Operation
66A	156.325	156.325	Port Operation

CH	Ship Tx	Ship Rx	Type of Operation
67	156.375	156.375	Commercial (Intership), 1W
68	156.425	156.425	Non-commercial
69	156.475	156.475	Non-commercial
71	156.575	156.575	Non-commercial
72	156.625	156.625	Non-commercial (Intership)
73	156.675	156.675	Port Operation
74	156.725	156.725	Port Operation
77	156.875	156.875	Port Operation
78A	156.925	156.925	Non-commercial
79A	156.975	156.975	Commercial
80A	157.025	157.025	Commercial
81A	157.075	157.075	US Government
82A	157.125	157.125	US Government
83A	157.175	157.175	US Government
84	157.225	161.825	Public Correspondence
85	157.275	161.875	Public Correspondence
86	157.325	161.925	Public Correspondence
87	157.375	161.975	Public Correspondence
88A	157.425	157.425	Commercial (Intership)

VHF WEATHER CHANNEL FREQUENCIES (USA VERSION)

CH	Receive Freq.	Service
WX1	162.550	NOAA Weather
WX2	162.400	NOAA Weather
WX3	162.475	NOAA Weather
WX4	162.425	
WX5	162.450	
WX6	162.500	
WX7	162.525	
WX8	161.650	Canada Weather
WX9	161.775	
WX0	163.275	

MEMORY CHANNEL LIST (To be filled by operator)

MEMO NO.	Stored Channel No.			Purpose/Remark	MEMO NO.	Stored Channel No.			Purpose/Remark
	INTL	USA				INTL	USA		
0	INTL	USA			0	INTL	USA		
	WX	Priv				WX	Priv		
1	INTL	USA			1	INTL	USA		
	WX	Priv				WX	Priv		
2	INTL	USA			2	INTL	USA		
	WX	Priv				WX	Priv		
3	INTL	USA			3	INTL	USA		
	WX	Priv				WX	Priv		
4	INTL	USA			4	INTL	USA		
	WX	Priv				WX	Priv		
5	INTL	USA			5	INTL	USA		
	WX	Priv				WX	Priv		
6	INTL	USA			6	INTL	USA		
	WX	Priv				WX	Priv		
7	INTL	USA			7	INTL	USA		
	WX	Priv				WX	Priv		
8	INTL	USA			8	INTL	USA		
	WX	Priv				WX	Priv		
9	INTL	USA			9	INTL	USA		
	WX	Priv				WX	Priv		

EXAMPLE OF RADIO LOG

**SHIP RADIO STATION LOG SHEET
(Recreational Vessels)**

Page No. _____ Name of Vessel _____ Radio Call _____

DATE ¹	TIME ²		CHANNEL OR FREQUENCY	PRIORITY MESSAGE TIME ²	MESSAGE ³	OPERATOR'S SIGNATURE
	Start	Stop				

- Log: Day, Month, Year
- Use UTC (formerly known as GMT) or Local Time. Show which used. Use 24-hour system; that is, 8:45 a.m. is entered as 0845, and 2:15 p.m. as 1415.
- Record as completely as possible all distress communications transmitted or intercepted and all urgency and safety communications transmitted. Retain logs for at least one year; for 3 years if they include entries related to distress; longer if they concern communications being investigated by the FCC or against which claims or complaints have been filed.

DISTRESS CALLING PROCEDURE

- ① Turn on the **POWER** switch.
- ② Confirm the display shows channel "16". If not, press the **CH16** key.
- ③ Pick up the microphone (or handset), press its **PTT** switch and then send the distress message.

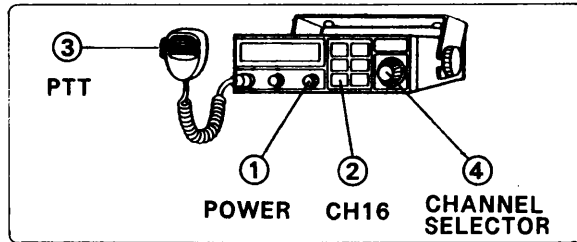

Speak **SLOWLY, CLEARLY** and **CALMLY**.

1. Say : "MAYDAY__ MAYDAY__ MAYDAY."
 2. Say : "This is _____, _____, _____." (your boat name)
 3. TELL WHERE YOU ARE (What nav. aids or landmarks are near?)
 4. STATE THE NATURE OF YOUR DISTRESS. (fire, collision, etc.)
 5. TELL WHAT ASSISTANCE IS REQUIRED.
 6. BRIEFLY DESCRIBE YOUR BOAT. _____ (type), _____ (length),
_____ (material), _____ (color), _____ (registration no.)
_____ (anything else you think will help rescuers to find you.)
 7. Say : "I will be listening on channel 16. _____ OVER." (your boat name)
- ④ Release the **PTT** switch and listen : Coast operator should answer. Follow his directions afterwards. If some other channel is specified, turn the **CHANNEL SELECTOR** dial. IF NO ONE REPLY, REPEAT THE ABOVE CALL AGAIN.