

FURUNO

OPERATOR'S MANUAL

SSB REMOTE STATION

MODEL RB-500

{ For ROM Version No. 1.04 (Standard)
1.00 (Option) }



FURUNO ELECTRIC CO., LTD.
NISHINOMIYA, JAPAN

©FURUNO ELECTRIC CO., LTD.

9-52, Ashihara-cho,
Nishinomiya, Japan

Telephone: 0798-65-2111
Telefax: 0798-65-4200

-Your Local Agent/Dealer

All rights reserved.

Printed in Japan

FIRST EDITION : JUN 1992
F : JUN. 4, 1999

(TENI)

PUB. No. OME-50700
RB-500





SAFETY INSTRUCTIONS

"**DANGER**", "**WARNING**" and "**CAUTION**" notices appear throughout this manual. It is the responsibility of the operator of the equipment to read, understand and follow these notices. If you have any questions regarding these safety instructions, please contact a FURUNO agent or dealer.



DANGER

This notice indicates a potentially hazardous situation which, if not avoided, will result in death or serious injury.



WARNING

This notice indicates a potentially hazardous situation which, if not avoided, could result in death or serious injury.



CAUTION

This notice indicates a potentially hazardous situation which, if not avoided, could result in minor or moderate injury, or property damage.



SAFETY INFORMATION FOR THE OPERATOR



WARNING



Do not open the cover of the equipment.

This equipment uses high voltage electricity which can shock, burn, or cause death. Only qualified personnel should work inside the equipment.

Do not disassemble or modify the equipment.

Fire, electrical shock or serious injury can result.

Immediately turn off the power at the ship's mains switchboard if water or foreign object falls into the equipment or the equipment is emitting smoke or fire.

Continued use of the equipment can cause fire, electrical shock or serious injury.



CAUTION

Do not place liquid-filled containers on the top of the equipment.

Fire or electrical shock can result if a liquid spills into the equipment.

Do not place heater near the equipment.

Heat can melt the power cord, which can result in fire or electrical shock.

Do not operate the unit with wet hands.

Electrical shock can result.

Use the correct fuse.

Use of the wrong fuse can cause fire or equipment damage.

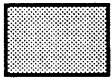

RB-500 REMOTE STATION Operator's Guide

Operation		Key Input	Page
Backlighting of keyboard and LCD		Press DIMMER key.	2-1
Speaker on or off		Press 4 key.	2-1
Frequency input	Tx & Rx	TX - RX - freq. - ENT	2-2
	Tx	TX - freq. - ENT	2-3
	Rx	RX - freq. - ENT	2-4
ITU channel recall	Tx - Rx pair	ITU - CH No. - ENT	2-5
	Tx	ITU - TX - CH No. - ENT	2-6
	Rx	ITU - RX - CH No. - ENT	2-7
User channel recall	Tx - Rx pair	RCL - CH No. - ENT	2-8
	Tx	RCL - TX - CH No. - ENT	2-9
	Rx	RCL - RX - CH No. - ENT	2-10
Channel number confirmation		ENT (while pressed and held down)	2-11
Tx channel monitoring		RX - ENT (while pressed and held down)	2-12
Tx output power selection		HI/LOW	2-13
Class of emission selection		MODE	2-13
Scanning	Settings of stop time and stop signal level, etc are controlled by SSB radiotelephone.	SCAN , in channel mode. "SCAN" appears on the display.	2-14
Sweeping		SCAN , in frequency mode. "SWEEP" appears on the display.	2-14
Duplex on or off (Duplex filter is turned on and BK turns off.) → Not applicable to FS-1502/1552/1562		Press DUPLEX . "DUP" appears on the LCD when duplex is turned on.	2-14
<i>To enable duplex communications in the RC-808 series, both the RCVR DUP FIL switch and the HANDSET No. 1 RCVR switch on the controller must be on.</i>			
Antenna coupler tuning (not applicable to RC-808 series radio console)		Press TX TUNE . The coupler is tuned also when the PTT switch is pressed, after changing channel or frequency.	2-15
Intercom communications (*1)		INTCOM - Intercom no. - ENT	2-16
Squelch on or off (*1)		Press SQ . "SQ" appears on the display when the squelch is on.	2-1

(*1) Availability depends on radiotelephone connected. See the table on the next page.

Availability of Squelch Control and Intercom

Squelch control and intercom are not available when the equipment not supporting remote control of these functions is connected to the RB-500. The table which follows shows the availability of those functions.

Equipment	Squelch control	Intercom	Remarks
FS-1502	Not available	Available	
FS-1552			
FS-1562			
FS-5000	Available	Available	FS-5000/8000 AF board 05P0356-33 <u>and after</u> is required.
FS-8000			
RCX	Not available	Not available	

Table of Contents

1	OPERATIONAL OVERVIEW	
	General	1-1
	Description of Controls	1-2
	LCD Indications	1-4
	Operating Conventions	1-5
	Status at start up	1-5
	Frequency display	1-5
	Key operation	1-5
	The HOOK Key	1-6
	Priority	1-7
2	OPERATION	
	Basic Operations	2-1
	Turning the power on and off and adjusting speaker volume	2-1
	Turning the squelch on and off	2-1
	Turning the speaker on and off	2-1
	Adjusting backlighting of LCD and keyboard	2-1
	Frequency Input Through Keyboard	2-2
	Recalling ITU Channel	2-5
	Recalling User Channel	2-8
	Confirming Channel Number	2-11
	Watching Tx Channel	2-12
	Selecting Class of Emission	2-13
	Selecting RF Output Power	2-13
	Scanning	2-14
	Sweeping	2-14
	Duplex On and Off	2-14
	Antenna Coupler Tuning	2-15
	Intercom Communication	2-16
	Calling	2-16
	Receiving	2-17
3	MAINTENANCE AND TROUBLESHOOTING	
	Routine Maintenance	3-1
	Troubleshooting for the User	3-2
	Location of breaker	3-3
	Troubleshooting for qualified personnel (self test)	3-4
	Basic procedure	3-4
	Keyboard test	3-5
	SCI test	3-6
	Control line	3-7
	Displays of Program No. & Remote Station No.	3-9
	SPECIFICATIONS	A-1

1 OPERATIONAL OVERVIEW

This chapter provides an introduction to the RB-500.

General

- Function** The RB-500 provides for remote control of a FURUNO SSB radiotelephone equipped with MIF radio interface (FS-1502, FS-5000/8000, etc.). Splashproof and compact construction permits installation almost anywhere.
- Connection** The RB-500 connects directly to the stand-alone type SSB radiotelephone or to the terminal board of the radio console type SSB radiotelephone. Up to four remote stations can be connected by using the Distributor DB-500.
- Power** The RB-500 is powered by the SSB radiotelephone or the Distributor.
- Monitor** When RB-500 is connected to the FS-1562 having ROM version 107 and after, radiotelephone status can be monitored on the RB-500.

Description of Controls

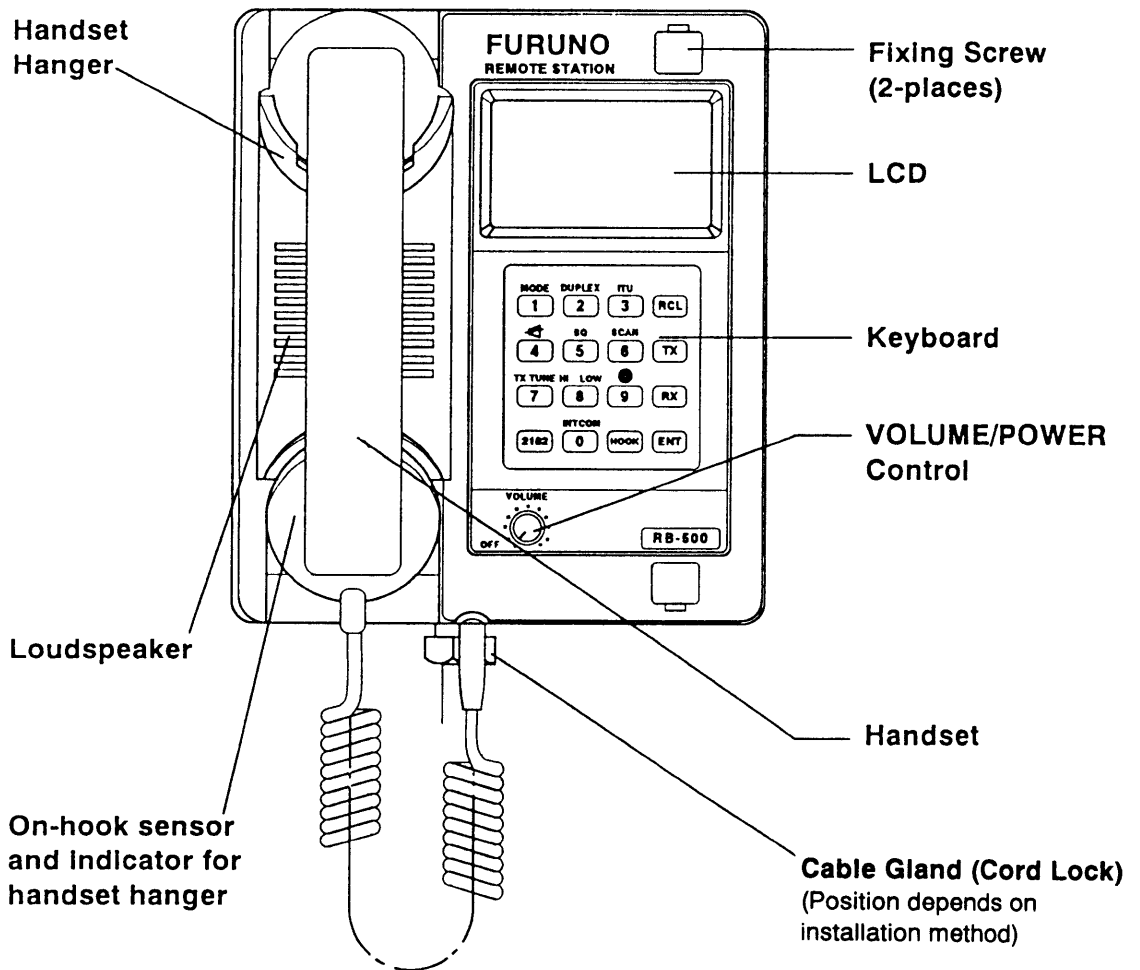

Figure 1-1 RB-500

Keyboard

The keyboard consists of 16 keys. Keys 0–9 have two functions: numeric data input and the function which appears above these keys.

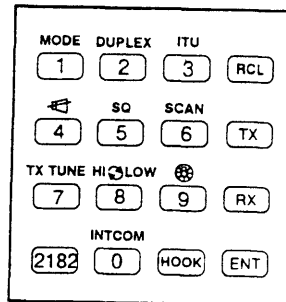

Figure 1-2 Keyboard

- **NOTE:** 1. *SQ* (squelch control) key is available for FS-5000 series equipped with AF board 05P0356-33 and after.
- **NOTE:** 2. *INTCOM* (Intercom) key is available for FS1502/1552/1562, FS-5000 series equipped with AF board 05P0356-33 and after.

LCD Indications

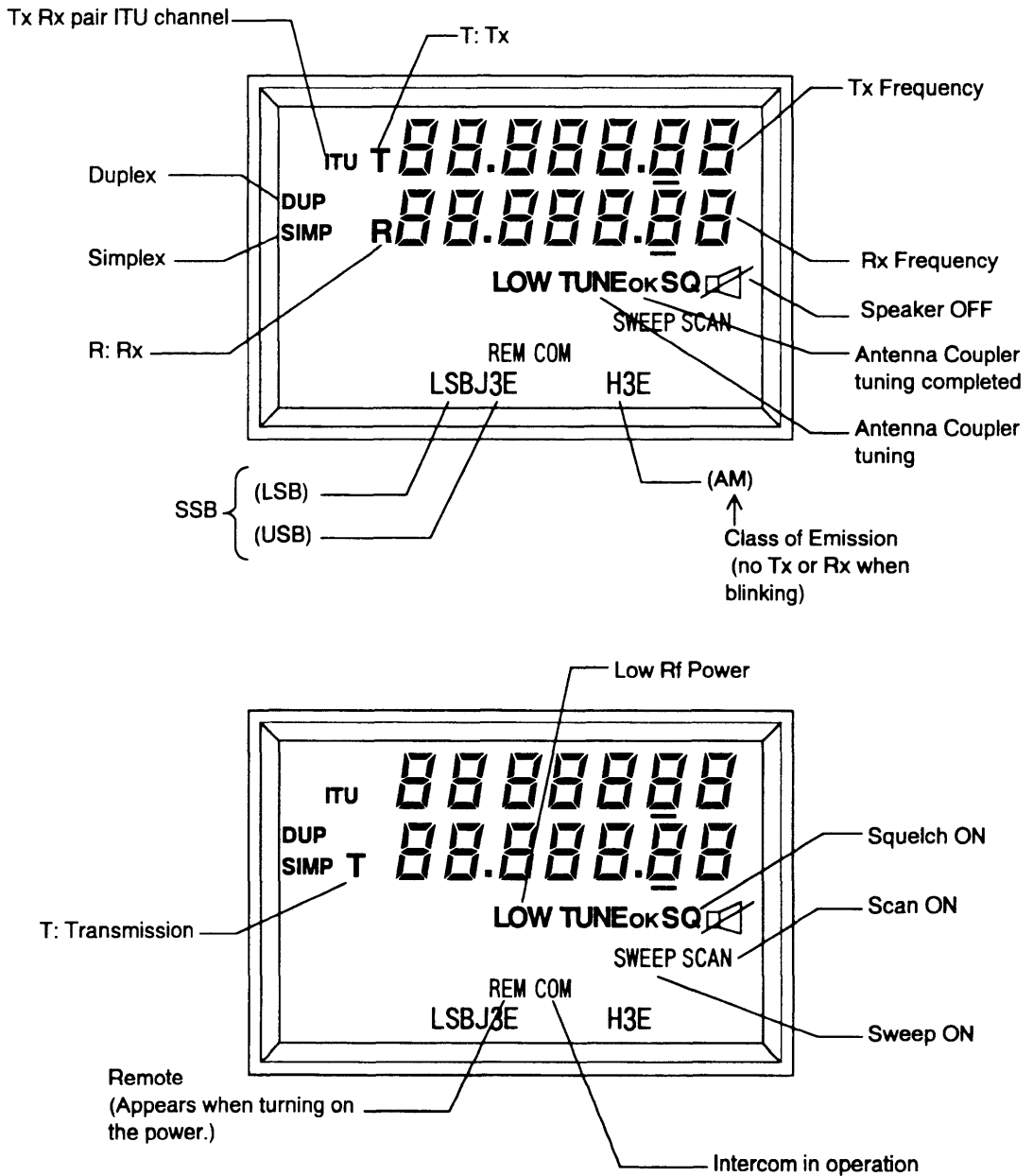

Figure 1-3 LCD indications

Operating Conventions

Status at start up

When turning on the power the “REMote” indication appears. This means the SSB radiotelephone is awaiting command from the RB-500. To start remote operation, release the handset from the hanger or press **HOOK**.

When the RB-500 is connected to the FS-1562, radiotelephone status can be monitored in on-hook condition by cutting jumper JP5 on the MAIN Board in the RB-500.

Not monitoring radiotelephone

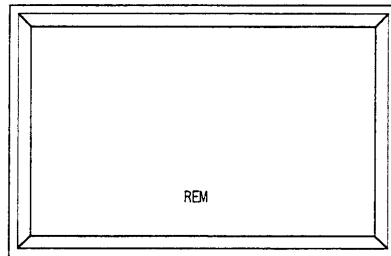

•Control at SSB radiotelephone.

Monitoring radiotelephone (For FS-1562)

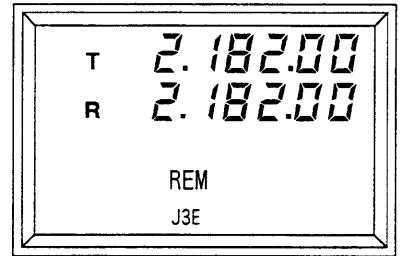

•Control at SSB radiotelephone.

Figure 1-4 “REMote” indication

Frequency display

To display frequency, etc., press **HOOK** or release the handset from the hanger.

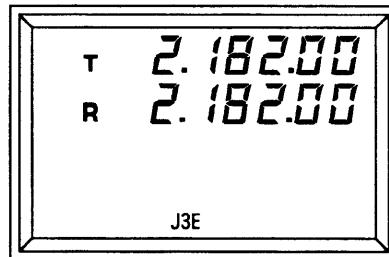

→ When frequencies of radiotelephone are set to 2182 kHz.

Figure 1-5 Initial Indication

Control at the remote station is possible when REM is not displayed.

Key operation

- Valid key input releases a beep.
- Invalid key input releases a series of beeps and the unit reverts to the previous display.

The HOOK Key

Overview

The HOOK key enables remote control of the SSB radiotelephone with the handset hung. This feature is useful for keeping a continuous watch on the radiotelephone. When the key is on you will hear receiver noise through the speaker.

Not monitoring radiotelephone

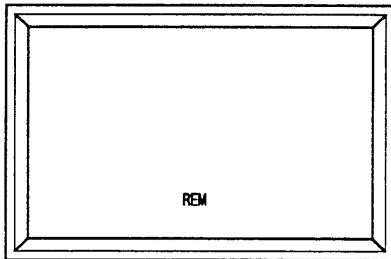

•Control at SSB radiotelephone.

Each press of
HOOK key

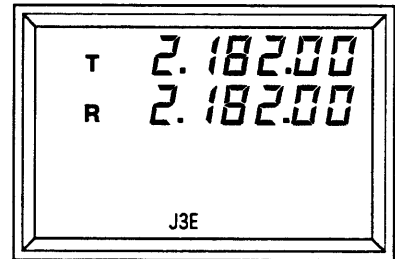

•Ready to receive.
•Control at remote station.

Monitoring radiotelephone (For FS-1562)

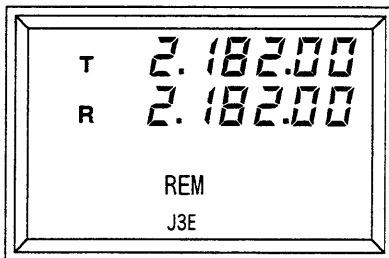

•Control at SSB radiotelephone.

Each press of
HOOK key

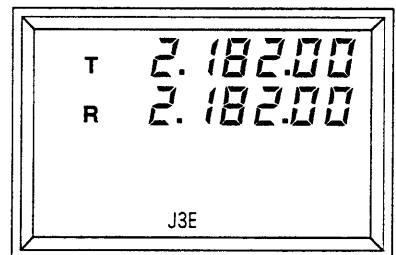

•Ready to receive.
•Control at remote station.

Figure 1-6 How the HOOK key works

Priority

What is priority?

The SSB radiotelephone receives commands sent from peripheral equipment and one or more remote stations. If peripheral equipment and the remote stations were to transmit commands without protocol, the radiotelephone could not determine which command is most important. This is why there is priority; priority determines which unit's commands take precedence over those of other units.

Determination of priority

Case 1: RB-500 + SSB

The remote station has priority. When the handset is released from the hanger the remote station can control the SSB. And when the handset is hung, control is returned to the SSB.

Case 2: RB-500 + SSB + NBDP or DSC

Distress alert transmission by DSC (Digital Selective Calling) Terminal or DMC (Distress Message Controller) takes absolute priority. In all other instances priority goes to the first-received command.

Case 3: several RB-500 + SSB + DB-500 + NBDP or DSC

Up to four remote stations can be installed by using Distributor DB-500. The terminal board on the DB-500 contains five terminals, numbered 1–5. Terminal #1 is for connection of SSB radiotelephone, terminals #2–5 for connection of remote stations. Remote station priority is assigned by terminal number; 2 for highest, 5 for lowest. If an NBDP (Narrow Band Direct Printing) Terminal is installed (for the FS-1502) connect it to terminal #5. If the DSC is installed connect it to terminal #2. Distress alert transmission by the DSC or DMC takes precedence over all other communications.

Important

When the 2182 key of the SSB radiotelephone is pressed, the remote station can not control the SSB. (Remote function: off)

However RB-500 can control FS-1562 when you give priority to the RB-500 by system setting on FS-1562(ROM ver.107 and after of FS-1562).

2

OPERATION

Basic Operations

Turning the power on and off and adjusting speaker volume

The **VOLUME** control turns on and off the power and adjusts the volume of the speaker. To turn on the power, turn the control clockwise until you hear a click. Further clockwise rotation adjusts the volume of the speaker. To turn off the power, turn the control counterclockwise until you hear the click, **after hanging the handset**. Otherwise, the keys on the SSB radiotelephone lock.

Turning the squelch on and off

The **SQ** key turns the squelch on and off. To adjust the **VOLUME**, press the **SQ** key if nothing is heard through the speaker.

This is applicable to FS-5000 series equipped with AF board 05P0356-33 and after.

Turning the speaker on and off

The **4** key turns the speaker on and off. When the speaker is on you can hear receiving noise when the handset is released from the hanger or the **HOOK** key is pressed. When the speaker is off, the "speaker off mark" appears on the display.

Adjusting backlighting of LCD and keyboard

The **DIMMER** key adjusts the backlighting of the LCD and the keyboard, in levels of bright, medium, dim and off.

Frequency Input Through Keyboard

Tx - Rx frequency, simplex

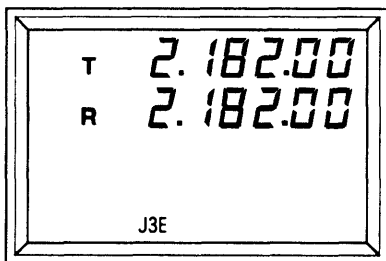

Press **TX**.

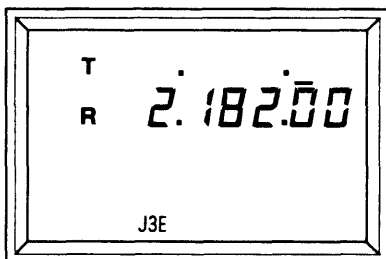

Tx frequency disappears.

Press **RX**.

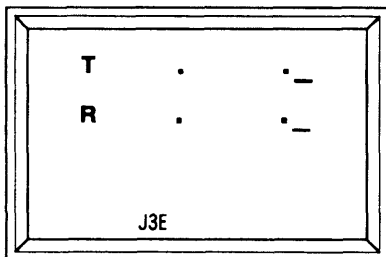

Rx frequency disappears.

Input frequency with numeric keys.
(up to 0.1kHz)

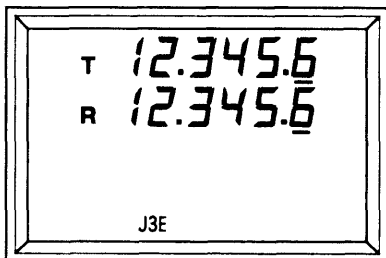

Press **ENT**.

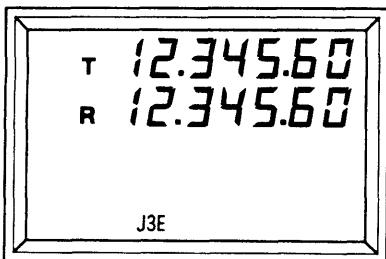

- Sequence of operation of **TX** and **RX** keys may be reversed.

Figure 2-1 Tx - Rx frequency input

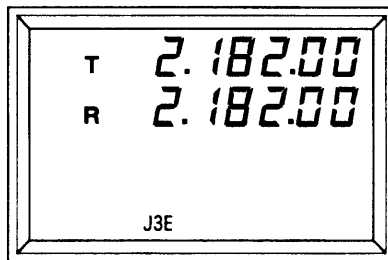
Tx frequency

Press **TX**.

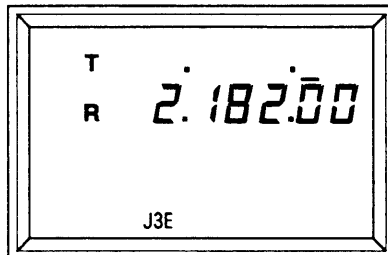

Tx frequency disappears.

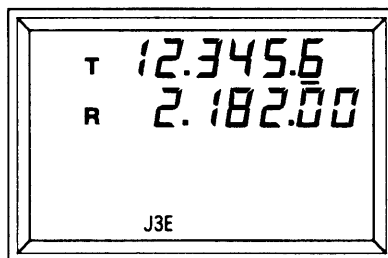

Input frequency with numeric keys.
(up to 0.1kHz)

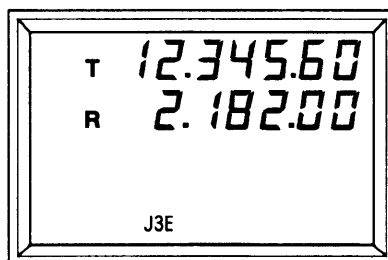

Press **ENT**.

Figure 2-2 Tx frequency input

Rx frequency

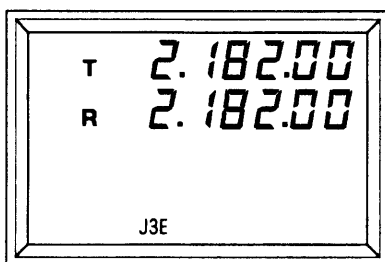

Press **RX**.

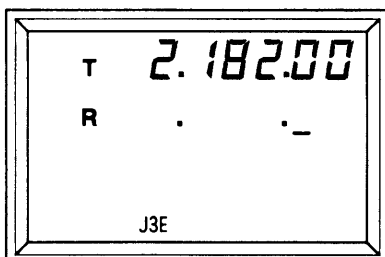

Rx frequency disappears.

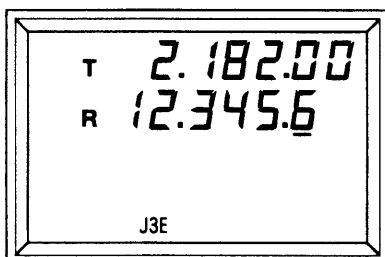

Input frequency with numeric keys.
(up to 0.1kHz)

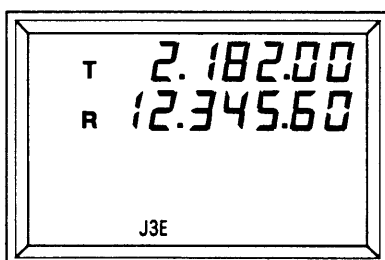

Press **ENT**.

Figure 2-3 Rx frequency input

Recalling ITU Channel

Tx - Rx pair ITU channel

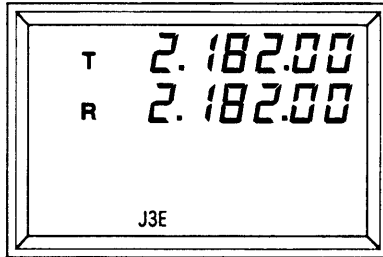

Press ITU.

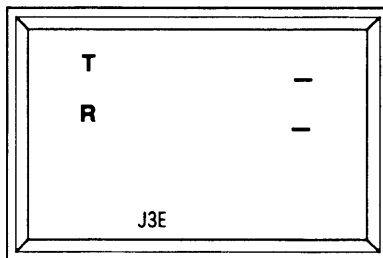

Both Tx and Rx frequencies disappear.

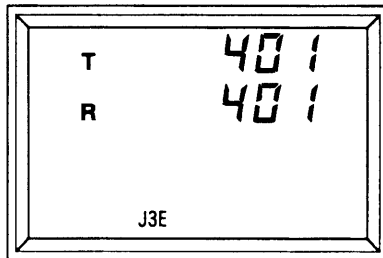

Input channel with numeric keys and press ENT.

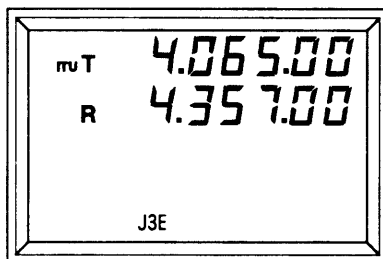

Tx and Rx frequencies and "ITU" appear on the display.

Figure 2-4 ITU Tx - Rx pair input

Tx ITU channel only

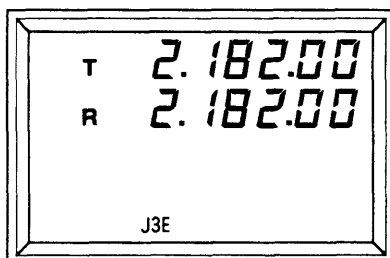

Press **ITU**.

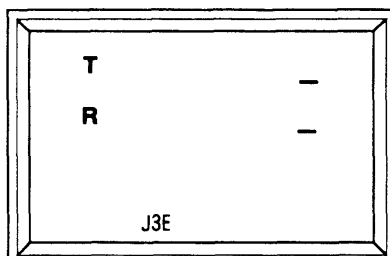

Rx and Tx frequencies disappear.

Press **TX**.

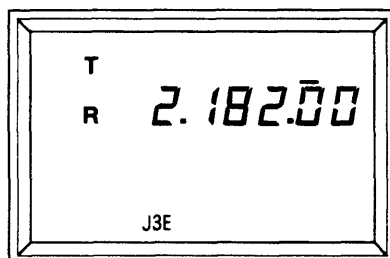

Previous Rx frequency appears.

Input channel with numeric keys.

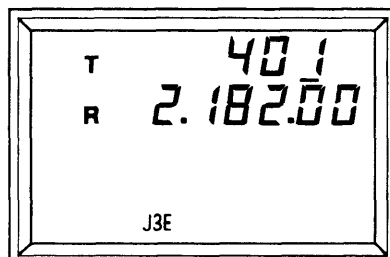

Press **ENT**.

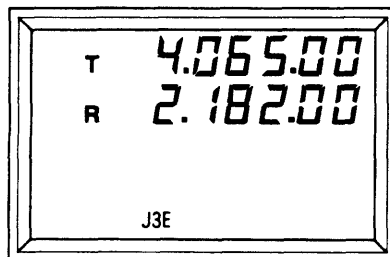

Rx and Tx frequencies appear.

Figure 2-5 ITU Tx channel input

Rx ITU channel only

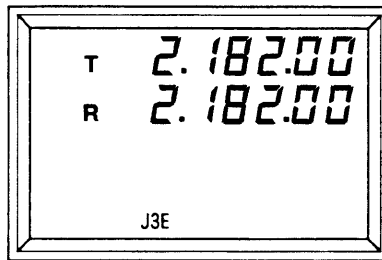

Press **ITU**.

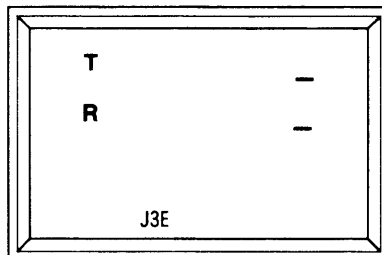

Rx and Tx frequencies disappear.

Press **RX**.

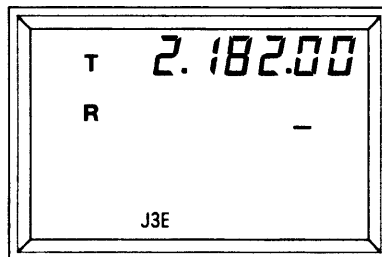

Previous Tx frequency appears.

Input channel with numeric keys.

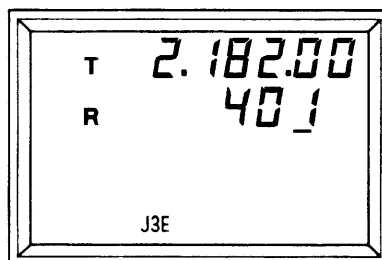

Press **ENT**.

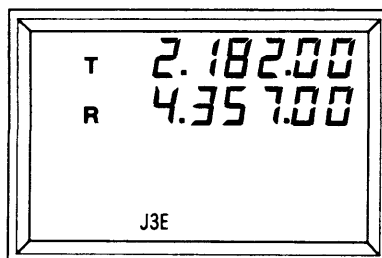

Tx and Rx frequencies appear.

Figure 2-6 ITU Rx channel input

Recalling User Channel

User Tx - Rx pair (User channel data should be stored in the SSB radiotelephone beforehand.)

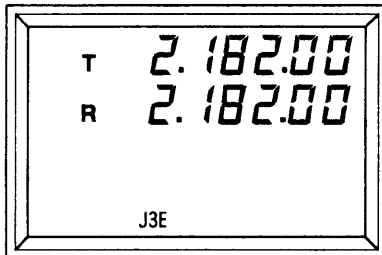

Press **RCL**.

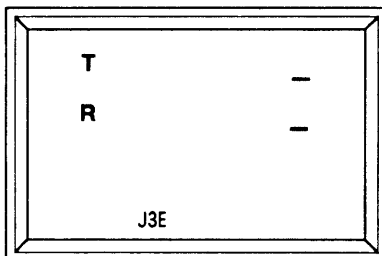

Tx and Rx frequencies disappear.

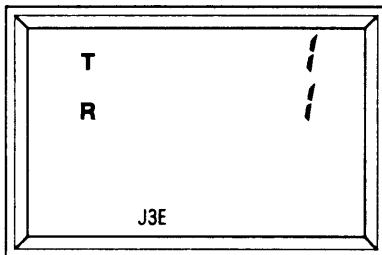

Input channel with numeric keys.
(For example, ch. 1.)

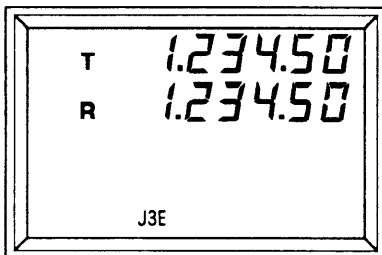

Press **ENT**.

Tx and Rx frequencies appear.

Figure 2-7 User Tx - Rx pair input

User Tx channel

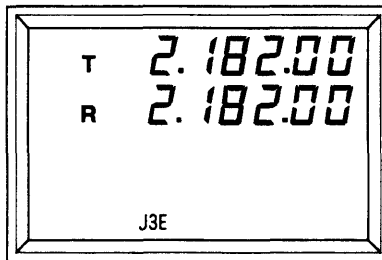

Press **RCL**.

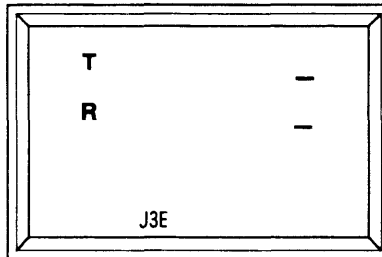

Rx and Tx frequencies disappear.

Press **TX**.

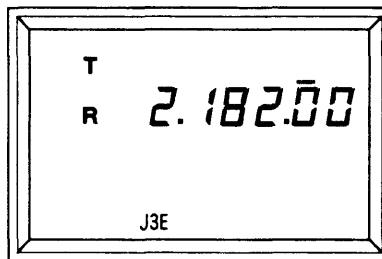

Previous Rx frequency appears.

Input channel with numeric keys.
(For example, ch. 1.)

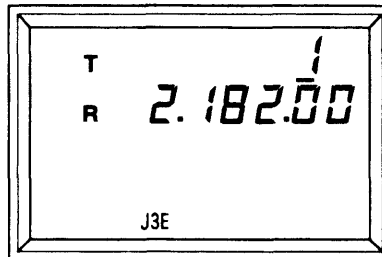

Press **ENT**.

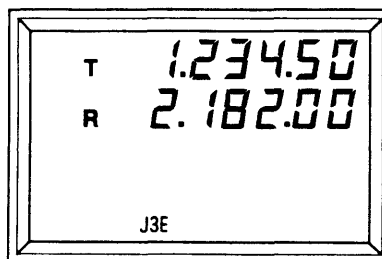

Tx and Rx frequencies appear.

- Sequence of operation of **RCL** and **TX** keys may be reversed.

Figure 2-8 User Tx channel input

User Rx channel

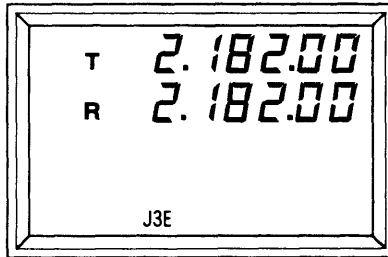

Press **RCL**.

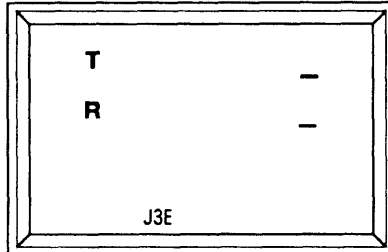

Rx and Tx frequencies disappear.

Press **RX**.

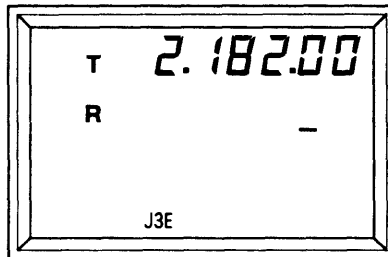

Previous Tx frequency appears.

Input channel with numeric keys.

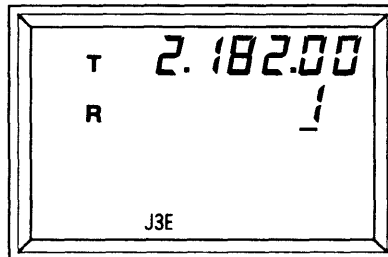

Press **ENT**.

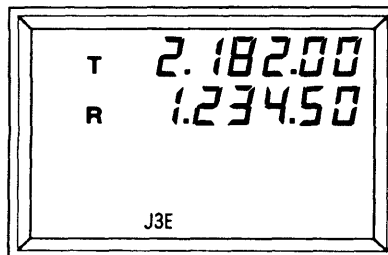

Tx and Rx frequencies appear.

- Sequence of operation of **RCL** and **RX** keys may be reversed.

Figure 2-9 User Rx channel input

Confirming Channel Number

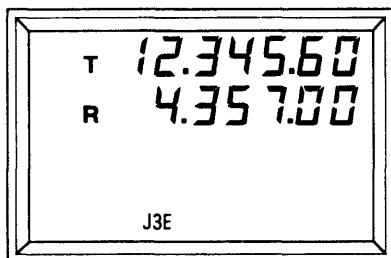

Press and hold **ENT**.

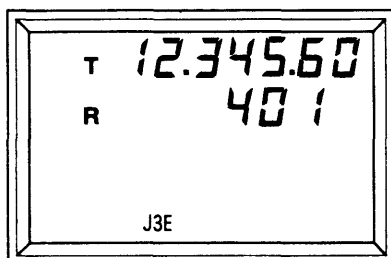

Channel no. appears.
(see note 1.)

Release **ENT**.

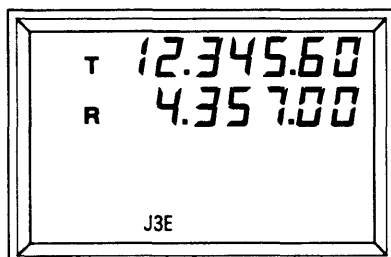

Frequencies appear.

Figure 2-10 How to confirm channel number

- **NOTE 1:** Channel number does not appear when frequency is input directly through the keyboard. (When Tx frequency is input, Rx channel appears but Tx channel does not.)
- **NOTE 2:** "ITU" appears on the display when ITU Tx + Rx pair is input.

Watching Tx Channel

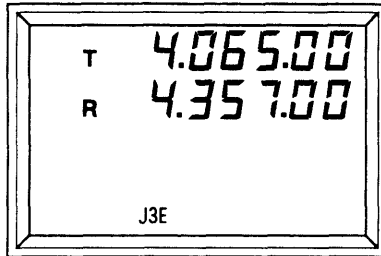

Press **RX**.

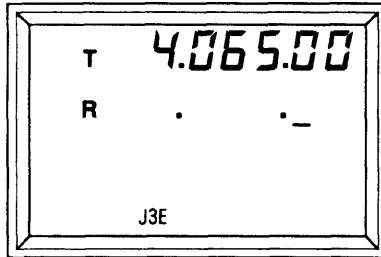

Rx frequency disappears.

Press and hold down **ENT**.

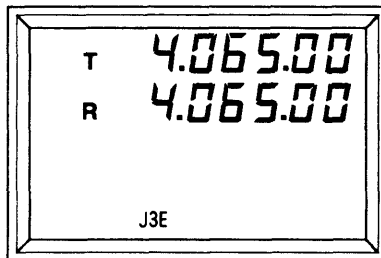

Rx and Tx frequencies are the same.

Release **ENT**.

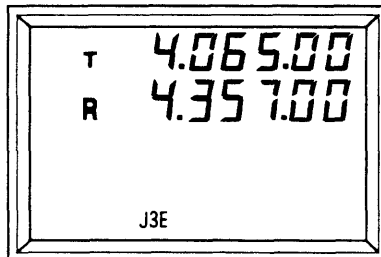

Original Rx frequency appears.

Figure 2-11 Watching Tx channel

Selecting Class of Emission

Operation

Press the **MODE** key to select class of emission. The class of emission selected at the SSB radiotelephone appears. However in the case of distress J3E is used.

Selecting RF Output Power

Operation

Each press of the **HI/LOW** key selects high or low output power. "LOW" appears on the display when selected for low. For short range communications use low power when possible to avoid disturbing other's communications.

Output Power at "LOW"

- FS-5000/8000..... "minimum" power
= the lowest power setting
- FS-1502/1552..... Approx. 70Wpep
- FS-1562 Approx. 70Wpep
- RC-XX8-2T/3T type console... "minimum" power set at
FX-3058 exciter unit

Scanning

Operation

To start scanning, in the channel mode, press **SCAN**. “SCAN” appears on the display. You can stop scanning by pressing the key again or the PTT switch. Scanning parameters such as scan stop time/level cannot be adjusted by the remote station.

- **NOTE:** *The remote station cannot initiate scanning on a rack type (RC-808 series) all-wave receiver.*

Sweeping

Operation

Input Rx frequency or Rx channel and press **SCAN** to start sweeping (in frequency mode). “SWEEP” appears on the display. You can stop scanning by pressing the key again or the PTT switch. Sweeping parameters such as sweep stop time/level cannot be adjusted by the remote station.

- **NOTE:** *The remote station cannot initiate sweeping on a rack type (RC-808 series) all-wave receiver.*

Duplex On and Off

Operation

The **DUPLEX** key enables and disables duplex communications. “DUP” appears on the display when the key is turned on.

- **NOTE:** *In case of rack type radio console (RC-808 series), both the RCVR DUP FIL switch and the HANDSET No.1 RCVR switch on the controller must be on to enable duplex communications.*

Antenna Coupler Tuning

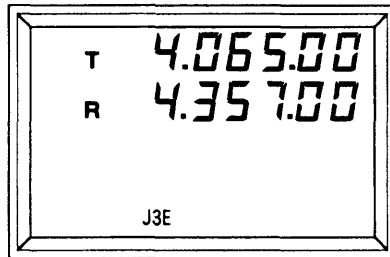

Press TX TUNE.

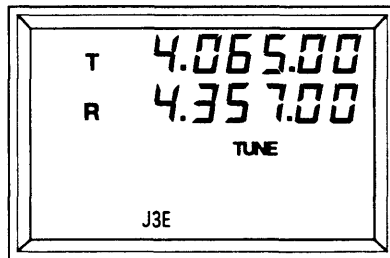

"TUNE" appears.

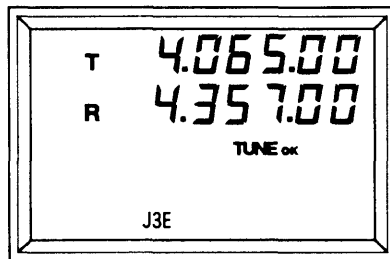

When the antenna coupler is tuned, "OK" appears.

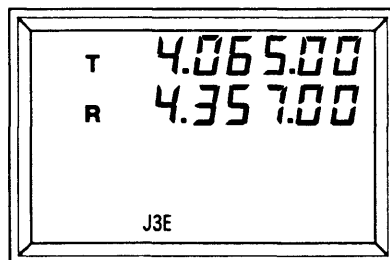

When the antenna coupler could not be tuned, there is no OK display, several beeps sound and "TUNE" disappears.

Figure 2-12 Antenna coupler tuning

- **NOTE 1:** The procedure above is applicable only to antenna coupler-equipped SSB radiotelephone; FS-5000/8000, RC-5000/8000, FS-1502/1552/1562, etc.
- **NOTE 2:** The antenna coupler is also automatically tuned each time the PTT switch is pressed, after changing Tx channel or frequency.

Intercom Communication

Overview

The intercom function provides voice communication between the remote station and SSB radiotelephone. (This is applicable to the FS-1502/1552/1562, FS-5000 series equipped with AF board 05P0356-33 and after.)

Calling

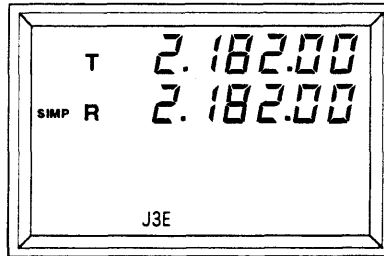

Pick up the handset.

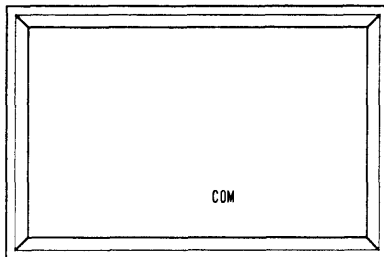

Press **INTERCOM**.

"COM" (only) appears.

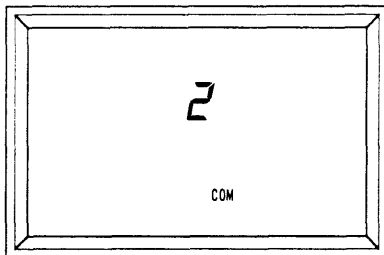

Enter your intercom no. (remote station no.)

(For example, 2.)

Input intercom no. appears.

- Remote station number can be confirmed by turning on the power while pressing and holding down the **ENT** key. Refer to page 3-9.

Press **ENT**.

(The SSB radiotelephone releases several beeps. If the operator responds pick up handset, press PTT switch and talk into the receiver.)

Figure 2-13 Calling by intercom

Exiting the intercom function

Press any key or hang up the handset.

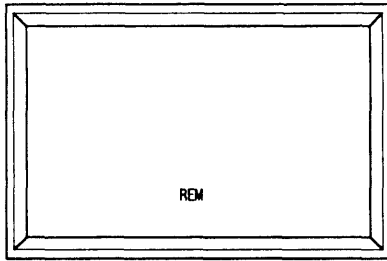
Receiving

"REM" must appear on the display (handset must be hung) to enable the intercom.

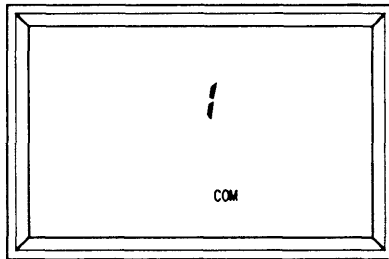

At the remote station, your intercom no. (remote station no.) appears on the display. "COM" lights and several beeps sound.

Pick up the handset and press PTT switch and talk into receiver.

Figure 2-14 Receiving intercom call

Exiting the intercom function

Press any key or hang up the handset.

3

MAINTENANCE AND TROUBLESHOOTING

This chapter provides the procedures necessary for the maintenance and troubleshooting of this unit.

Routine Maintenance

Regular Check

Regular maintenance is essential for good performance. A regular maintenance program should be established and should include the checks described in Table 3-1.

Table 3-1 Routine maintenance

Item	Check
Main Unit	<p>The external surfaces of the RB-500 may be cleaned when necessary. The only cleaning agent recommended for these surfaces is a mild detergent in water. Apply the solution sparingly with a stiff, non-metallic brush to work all loose dirt away from the remote station. A soft, absorbent lintless cloth or tissue should then be used to dry the unit. Be sure no water remains entrapped in crevices or connectors.</p> <p>If the unit is exposed to water splash, a service technician should check it for watertightness at least every two years.</p>
Power	<p>The RB-500 is powered by 12 VDC +30%, -10% (10.8 V – 15.6 V) from the SSB radiotelephone or the Distributor.</p> <p>Regularly check the power source voltage to be sure it is within that rating.</p>
Handset Sensor	<p>A sensor in the RB-500 detects whether the handset is hung or not, by bouncing light waves off the reflecting seal attached near the center of the transmitter microphone. If the sensor is dirty or the seal is damaged, the sensor cannot perform its intended function. Clean the sensor and replace the seal (supplied) when necessary.</p>
Handset	<p>Check the transmitter microphone and receiver for foreign material.</p>

Troubleshooting for the User

Overview

This section provides troubleshooting checks which the user can do to restore normal operation.

Table 3-2 Troubleshooting table for the user

IF...	THEN...	REMEDY
the unit does not work at all	<ul style="list-style-type: none"> the radiotelephone (or Distributor) may be off. the MIF cable may be loose. 	<ul style="list-style-type: none"> Turn on the radiotelephone (or Distributor). Connect the cable.
the LCD is functioning normally but no receiver noise	<ul style="list-style-type: none"> the speaker is off. the squelch on SSB radiotelephone is on. 	<ul style="list-style-type: none"> Press the 4 key.
the entire LCD is blinking	<ul style="list-style-type: none"> the ROM data is corrupted. 	<ul style="list-style-type: none"> Do the self test. (p. 3-4)
signal is weak (cannot receive)	<ul style="list-style-type: none"> the antenna cable of the radiotelephone may be damaged or disconnected. 	<ul style="list-style-type: none"> Check the radiotelephone for proper operation.
“T” appears but cannot transmit, or insufficient power	<ul style="list-style-type: none"> the output power may be selected for LOW. 	<ul style="list-style-type: none"> Set the output power for HIGH.
the PTT switch is pressed but “T” does not appear	<ul style="list-style-type: none"> the handset may be damaged. 	<ul style="list-style-type: none"> Check the handset and connector for damage. See the next page.
you cannot start scan/sweeping	<ul style="list-style-type: none"> noise level may be too high because squelch setting on the radiotelephone is too low. (squelch not provided on RV-118/128G receivers) 	<ul style="list-style-type: none"> Adjust squelch so noise just fades away.

**Location of breaker
(For qualified personnel)**

A breaker inside the unit protects it against reverse polarity of the ship's mains and equipment fault. When the unit cannot be operated, check if the breaker is protruding. If it is, push it in to restore normal operation. If the breaker trips again, call for service.

To access the breaker;

1. Remove the two fixing screw covers on the front panel.
2. Loosen the four fixing screws to open the unit.

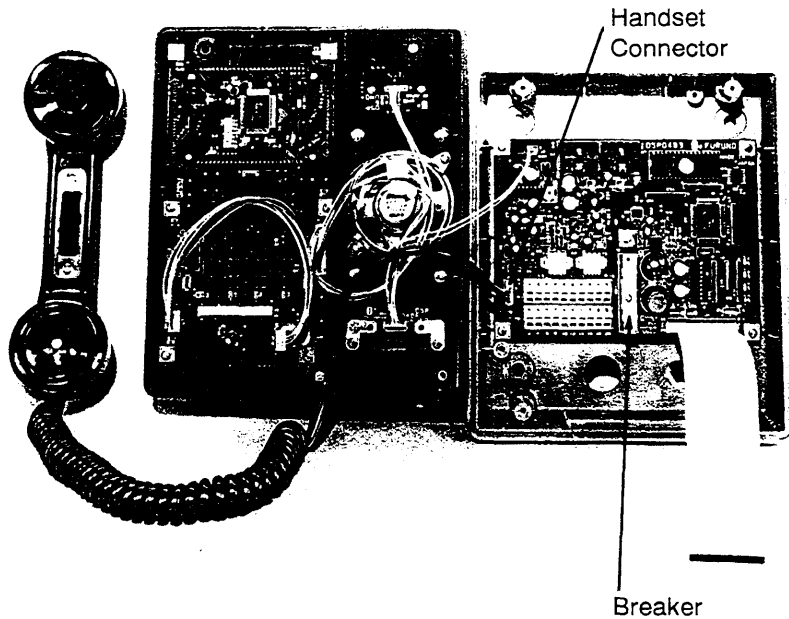

Figure 3-1 RB-500, unit opened

Troubleshooting for qualified personnel (self test)

Overview

This section covers the unit's built-in self test facility, which is intended for use by qualified personnel.

Three types of checks are available: keyboard, SCI (Serial Communication Interface: remote line test) and CPU control line (CPU test).

Basic procedure

1. While pressing and holding down HOOK key, turn on the power.

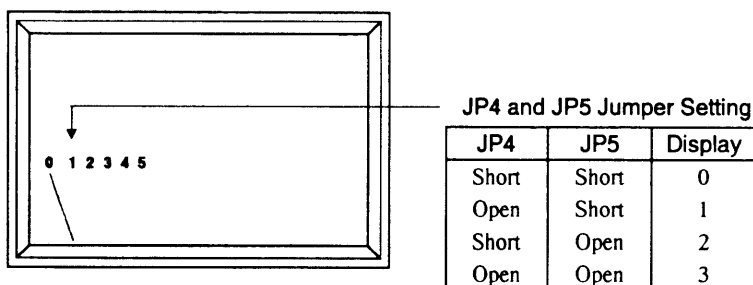

Figure 3-2

2. Select desired test;
 - press RCL for the keyboard test,
 - press the TX key for the SCI test, or
 - press RX for the CPU output test.

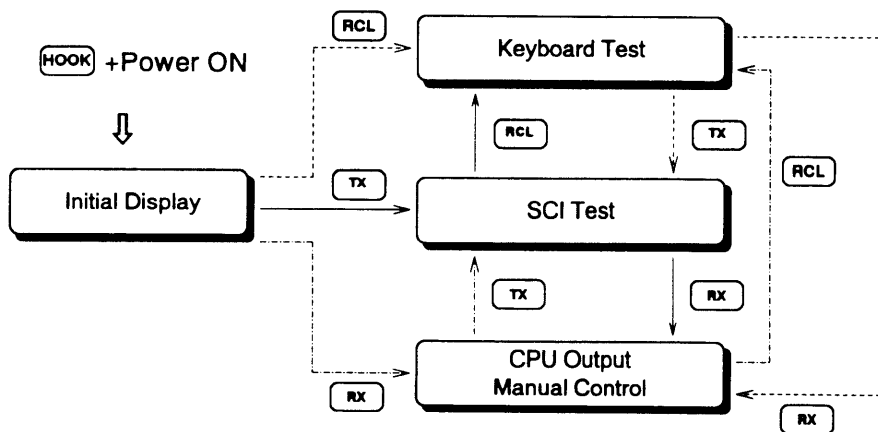

Figure 3-3

3. After the test is completed, you may select another test by pressing appropriate key, or turn off the power to exit the self test function.

Keyboard test

This test checks the keyboard, LCD and dimmer for proper operation. Press each key one by one. The indication associated with the key pressed appears on the display if the key is functioning normally. For example, press the 1 key. The display should look like Figure 3-4.

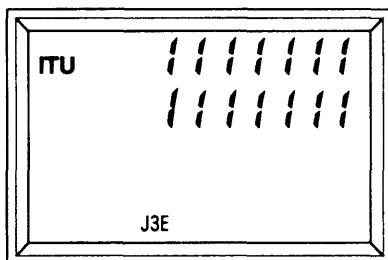

Figure 3-4

Table 3-3 shows key and associated indication.

Table 3-3 Key and associated indication

Key	Display	Key	Display	Key	Display	Key	Display
MODE 1	ITU, 111	DUPLEX 2	DUP, 222	ITU 3	SIMP, 333	RCL	Activates keyboard test.
A 4	A , 444	SQ 5	SQ, 555	SCAN 6	SCAN, 666	TX	Activates SCI test.
TX TUNE 7	TUNE, 777	HI LOW 8	LOW, 888	9	OK, 999	RX	Activates CPU manual control test.
2182	T,T,R, SWEEP	INTCOM 0	COM, 000	HOOK	LSB, J3E, R3E, H3E	ENT	_____

other indications

- Pressing the PTT switch displays “all segments.”
- Releasing the handset from the hanger displays “REM”

SCI test

preparation

Short terminals #1 (TXD-H) and #3 (RXD-H) and #2 (TXD-C) and #4 (RXD-C) on TB1 of the MAIN Board to loop back CPU output to the CPU.

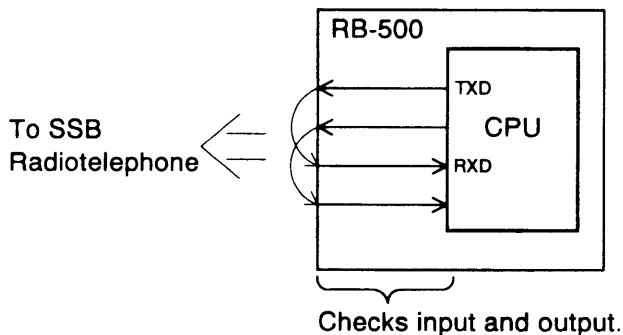

Figure 3-5

procedure

Press each key one by one. The unit releases a beep if the MIF command is output correctly. Table 3-4 shows key and associated MIF command.

Table 3-4 Key and associated MIF command

Key	MIF Command	Key	MIF Command	Key	MIF Command	Key	MIF Command
MODE 1	EM1	DUPLX 2	CAFR	ITU 3	SW1	RCL	Activates keyboard test.
4	SPS	50 5	SQS	SCAN 6	SCS	TX	Activates SCI test.
TX TUNE 7	TU	HV/LOW 8	PO3	9	CAID	RX	Activates CPU manual control test.
2182	FT0218200	MYCOM 0	1C1S	HOOK	FR0218200	ENT	—

Handset (HS) status	MIF Command
HS picked up	FZS
PTT switch pressed	RE
HS set to hanger	FZR

■ **NOTE:** MIF is the SSB radiotelephone control signal for FURUNO radio equipment.

Control line

This test checks the control lines for proper operation, by enabling manual change of output level (H, L) on CPU ports P50–P56. Table 3-5 shows key, port and initial state.

Table 3-5 Key, port and initial State

Key	Port controlled	Function (port name)	Initial State	Function when initial state is changed.
1	P51	HS MUTE	L	Handset Mute
2	P52	SP MUTE	H	Speaker ON
3	P53	Not used	L	Not Used
4	P54	RX MUTE	L	RX Mute
5	P55	H.T.	L	High tention: ON
6	P56	TX KEY	L	TX
7	P57	_____	_____	_____
8	_____	Set for H	_____	_____
9	_____	Set for L	_____	_____
0	P50	MIC OFF	L	Mic Off

procedure

1. Enter port number desired (P50 – P56) with numeric keys 0 – 6. To select port 51, for example, press 1. The display shown in Figure 3-6 appears.

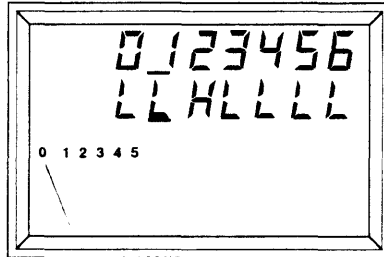
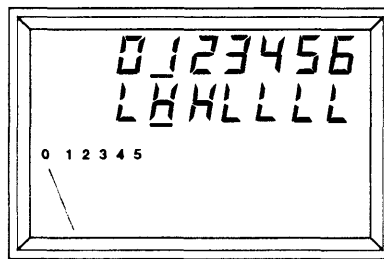

Figure 3-6

2. Set port output level; press 8 for high, or 9 for low.



(ex.) Press 8.
The P51 output is
set to H (high).

Figure 3-7

3. Press ENT. The screen returns to the beginning of the test. (Now the P51 output is set to high, so you should preset it to low for normal operation.)

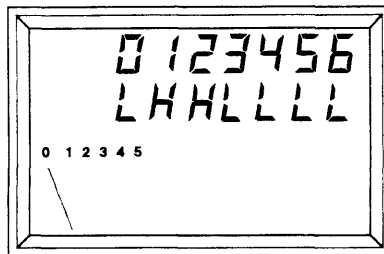

Figure 3-8

Displays of Program No. & Remote Station No.

Operation

Procedure

1. While pressing and holding down **ENT**, turn on the power.
2. The program number and remote station number appear on the display.

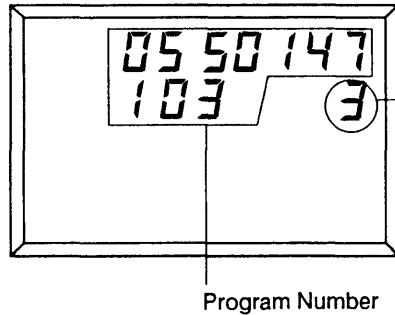

Remote Station Number
(depending on the settings
of JP1 and JP6)

No.	JP1	JP6
1	Short	Short
2	Open	Short
3	Short	Open
4	Open	Open

3. Turn off the power and turn it on again for normal operation.

SPECIFICATIONS

The RB-500 provides for remote control of a FURUNO SSB radiotelephone equipped with FURUNO MIF radio interface.

Connection	FS-1502/1552 (optional Remote-B kit required) FS-1562 (optional Remote-B board required) FS-5000/FS-8000 (modification required) RC-808-2T/RC-808-3T radio console (optional ROM required)
Control	Channel Frequency Class of emission Rf output power Squelch on and off (FS-5000/8000 equipped with AF board 05P0356-33 and after) Sweeping Scanning Antenna coupler tuning Intercom (FS-1502/1552/1562, FS-5000/8000 equipped with AF board 05P0356-33 and after)
Display	LCD
Audio Output	Internal speaker: 1 W min. (8 ohms) External speaker: 1 W min. (8 ohms) Handset speaker: 1 mW min. (200 ohms), max. better than 10 mW
Line I/O	0 dBm, 600 ohms
Handset Input	-46 dBm (600 ohms)
Communications Interface	MIF (FURUNO radio interface); current loop
MIF Cable Length	50 m max.
Dimensions and Weight	190 (W) × 75 (H) × 220 (D) mm, 2.5 kg
Environmental Conditions	Temperature: -20°C to +55°C Relative Humidity: 93% at +40°C Splashproof construction: Meets JIS (Japan Industrial Standard) C 0920
Power Supply	12 VDC +30%, -10% (floating ground), less than 1A, supplied from SSB radiotelephone or Distributor DB-500