

# FURUNO

## OPERATOR'S MANUAL

SSB RADIOTELEPHONE

MODEL FS-1503



**FURUNO ELECTRIC CO., LTD.**  
NISHINOMIYA, JAPAN

© **FURUNO ELECTRIC CO., LTD.**

9-52, Ashihara-cho,  
Nishinomiya, Japan

Telephone: 0798-65-2111  
Telefax: 0798-65-4200

All rights reserved. Printed in Japan

(TATA)

PUB. No. OME-56140  
FS-1503

•Your Local Agent/Dealer

FIRST EDITION : APR 1998  
C : JAN. 6, 1999



\* 00080822300 \*



# SAFETY INSTRUCTIONS

## DANGER

**Never touch the SSB antenna, antenna coupler or lead-in insulator when the SSB radiotelephone is transmitting.**

High voltage which will cause death or serious injury is present at the locations mentioned above when the SSB radiotelephone is transmitting.

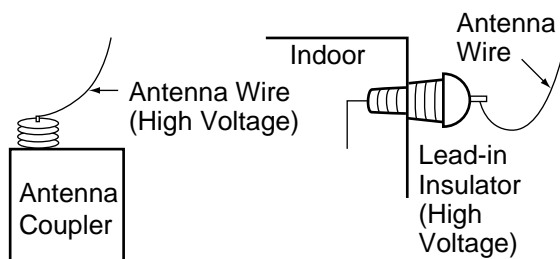

## WARNING



**Do not open the equipment.**

Hazardous voltage which can cause electrical shock exists inside the equipment. Only qualified personnel should work inside the equipment.

**Immediately turn off the power at the switchboard if water leaks into the equipment or something is dropped in the equipment.**

Continued use of the equipment can cause fire or electrical shock. Contact a FURUNO agent for service.

**Do not disassemble or modify the equipment.**

Fire, electrical shock or serious injury can result.

## WARNING

**Do not place liquid-filled containers on the top of the equipment.**

Fire or electrical shock can result if a liquid spills into the equipment.

**Immediately turn off the power at the switchboard if the equipment is emitting smoke or fire.**

Continued use of the equipment can cause fire or electrical shock. Contact a FURUNO agent for service.

**Make sure no rain or water splash leaks into the equipment.**

Fire or electrical shock can result if water leaks in the equipment.

**Keep heater away from equipment.**

A heater can melt the equipment's power cord, which can cause fire or electrical shock.

**Use the proper fuse.**

Fuse rating is shown on the equipment. Use of a wrong fuse can result in equipment damage.



**Do not operate the equipment with wet hands.**

Electrical shock can result.

## CAUTION

**A warning label is attached to the equipment. Do not remove the label. If the label is missing or illegible, contact a FURUNO agent or dealer.**

 **WARNING**   
To avoid electrical shock, do not remove cover. No user-serviceable parts inside.

 **警告**   
感電の恐れあり。  
サービスマン以外の方はカバーを開けないで下さい。内部には高電圧部分が多くあり、万一さわると危険です。

Name: Warning Label (1)  
Type: 86-003-1011-0  
Code No.: 100-236-230

# TABLE OF CONTENTS

<b>INTRODUCTION</b> .....	iii
<b>1. OPERATION</b>	
1.1 System Configuration .....	1-1
1.2 Transceiver Unit Description .....	1-2
1.3 Turning the Power On/Off .....	1-4
1.4 Adjusting the Backlighting .....	1-4
1.5 Turning the Loudspeaker On/Off .....	1-4
1.6 Turning the Squelch On/Off .....	1-4
1.7 Selecting Class of Emission, Turning AGC On/Off .....	1-4
1.8 Selecting Frequency .....	1-5
1.9 Displaying Station Name .....	1-10
1.10 Transmitting .....	1-10
1.11 Distress Call on 2182 kHz .....	1-11
1.12 Receiving .....	1-13
1.13 Frequency Scan .....	1-15
1.14 Frequency Sweep .....	1-17
1.15 MIF Commands .....	1-18
<b>2. OPERATION OF OPTIONAL EQUIPMENT</b>	
2.1 Telex Communication .....	2-1
2.2 Remote Station RB-500 .....	2-2
2.3 Intercom .....	2-2
<b>3. CHANGING SYSTEM SETTINGS</b>	
3.1 System Setup .....	3-1
3.2 Customizing by User .....	3-1
3.3 Writing User Channels .....	3-3
<b>4. MAINTENANCE</b>	
4.1 Weekly Checks .....	4-1
4.2 Diagnostic Test .....	4-2
4.3 LCD/Keyboard Test & ROM Version No. Confirmation .....	4-3
4.4 Maintenance .....	4-4
<b>5. TROUBLESHOOTING</b>	
5.1 Troubleshooting List .....	5-1
5.2 Error Indication .....	5-3
5.3 Replacing Fuses .....	5-3
<b>SPECIFICATIONS</b> .....	SP-1
<b>APPENDIX (Frequency Tables)</b> .....	A-1
TELEX CHANNELS .....	A-8
<b>INDEX</b> .....	Index-1

# INTRODUCTION

FURUNO Electric Company thanks you for selecting the FS-1503 MF/HF SSB Radiotelephone. We are confident you will discover why FURUNO has become synonymous with quality and reliability. To get maximum performance from your unit, please carefully read and follow the recommended procedures for operation and maintenance.

The FS-1503 is an all-purpose radiotelephone system especially designed for marine mobile communication in the frequency range 1.6 to 27.5 MHz. All ITU channels are preprogrammed. In addition, TX/RX frequencies can be preprogrammed into an E<sup>2</sup> PROM having a capacity of 199 frequency pairs.

## Features

- Station name entry available (channels 0-1 – 0-65)
- 2182 key provides for immediate selection of 2182 kHz (at FULL power automatically)
- Scan and Sweep receiving functions
- Where permitted user may program both Rx and Tx frequencies or Rx frequencies
- PROM stores all ITU SSB and TELEX frequencies
- Optional dummy load (in the Antenna Coupler) permits checking of transmitter
- Effective noise blanker cancels pulse noise
- Advanced voice and/or level-detecting type squelch circuit filters out noise and/or level
- Remote Station RB-500 available (requires optional REMOTE-B Board)
- System diagnostics program
- DSC and NBDP connections (requires optional REMOTE-A Board)

# 1. OPERATION

## 1.1 System Configuration

The basic FS-1503 consists of a Transceiver Unit, an Antenna Coupler, and an MIC. The figure below shows the FS-1503 system and optional equipment.

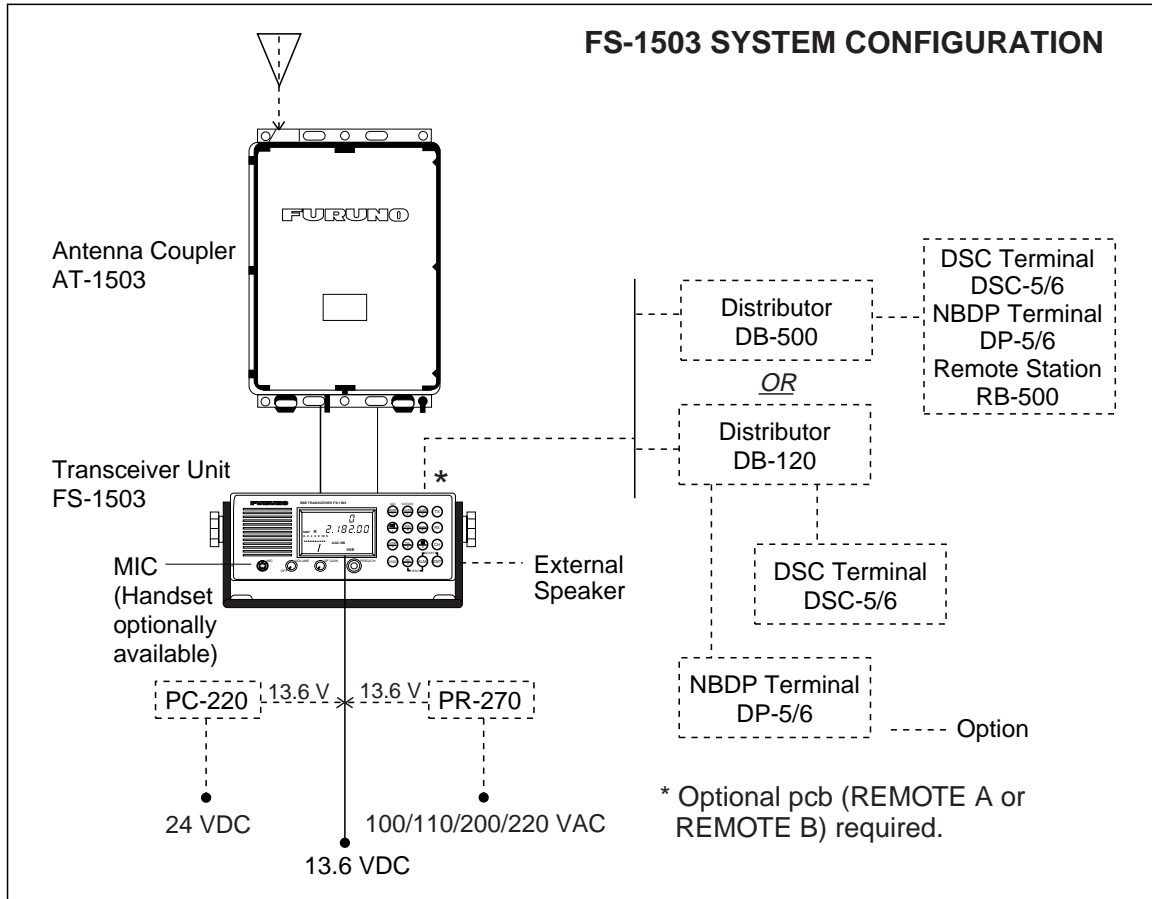

Figure 1-1 FS-1503 system configuration

## 1.2 Transceiver Unit Description

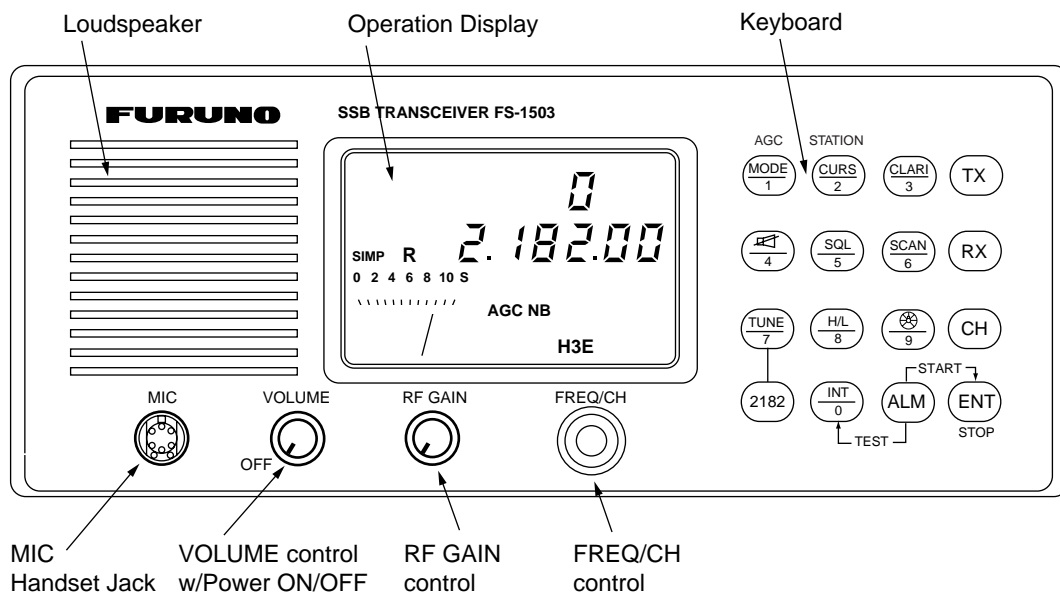



Figure 1-2 Transceiver unit

### Rotary controls

- VOLUME** Turns the power on and off and adjusts the loudspeaker volume.
- RF GAIN** Adjusts the receiver sensitivity.
- FREQ/CH** Changes frequency digit selected by the cursor and switches user/ITU channel and band.

### Keys

- [MODE/1] Selects a class of emission and turns AGC on/off. Press the [MODE/1] key repeatedly until the wanted class of emission appears. To turn AGC on or off, press the [MODE/1] key while pressing and holding down the [ENT] key.
- [CURS/2] Each pressing switches between band and channel when entering channels, or shifts among last four places when entering frequency. Pressing together with the [ENT] key displays station name or Rx frequency on the second line.
- [CLARI/3] Adjusts the receiver frequency for fine tuning when the frequency is set in terms of Channel No. Not active in direct frequency entry. The adjustable range is  $\pm 150$  Hz in 10 Hz steps ( $\pm 5$  kHz in 100 Hz steps on H3E).
- [TX] Selects a Tx frequency.
- [/4] Turns the internal or external loudspeaker on/off. The speaker mark appears on the display when the speaker is off.
- [SQL/5] Turns the squelch function on/off. "SQ" appears on the display when the squelch function is on.

- [SCAN/6] Turns the scan/sweep function on or off. “SCAN” or “SWEEP” appears on the display when the scan or sweep function is on.
- [RX] Selects an Rx frequency.
- [TUNE/7] Tunes the antenna coupler. “TUNE” appears during tuning, and “OK” appears after tuning is successfully completed.
- [H/L /8] Alternately selects high or low output power.
- [☼/9] Adjusts backlighting of the keyboard and the display.
- [CH] Enables entry of channel (by ten key).
- [2182] Selects 2182 kHz on H3E (J3E may be selected depending on system setting).
- [INT/0] Calls “remote station” (if connected). Press this key, enter station no. and then press [ENT] key.
- [ALM] Releases the two-tone alarm for 45 seconds. To transmit the alarm, press the [ENT] key while holding down the [ALM] key. To silence it, press the [ENT/STOP] key or the [ALM] key. Never press [ALM] + [ENT] except when own ship is in distress.
- [ENT] Concludes data entry.
- [0]...[9] Enter numeric data.

## Indications

The operation display provides the operational status by various marks and indications. Shown below are the location and meaning of all available indications. They do not appear all at once but when the related parts appear with respect to the mode selected.

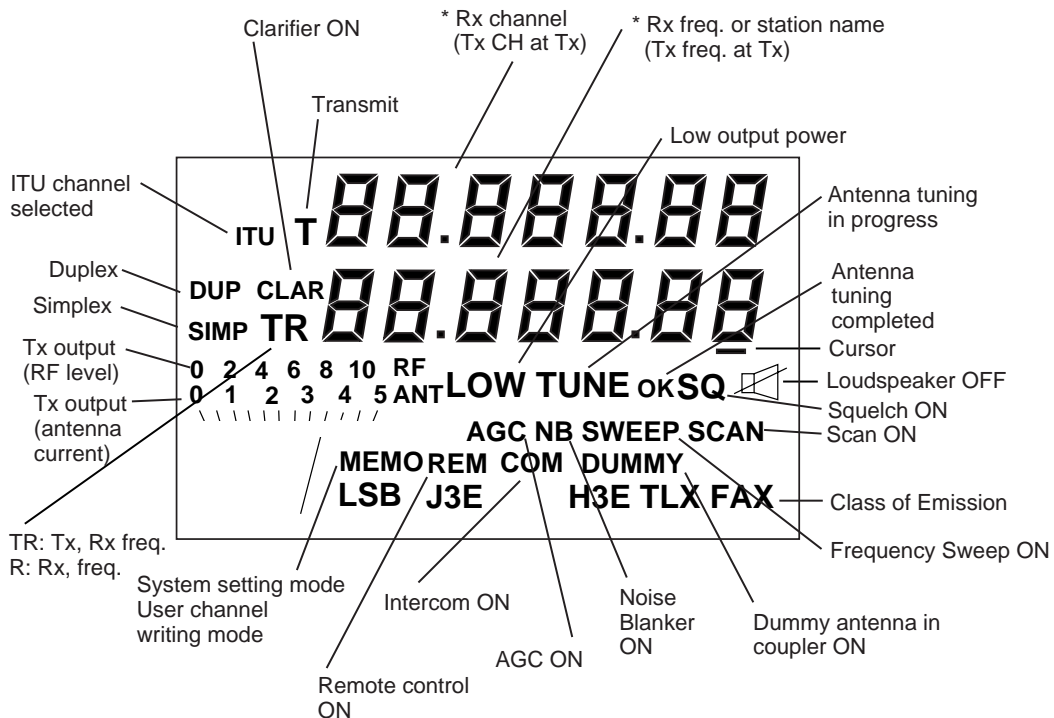

\* Tx/Rx CH only or Tx/Rx freq. only available thru system setting.

Figure 1-3 Indications



## 1.3 Turning the Power On/Off

The power switch is combined with the [VOLUME] control. Turn the [VOLUME] control clockwise until you hear a click. Further clockwise rotation of the control raises the loudspeaker volume. To turn off the power, turn the control fully counterclockwise until you hear the click.

## 1.4 Adjusting the Backlighting

The [☉/9] key adjusts the backlighting for the operation display and the keyboard. Each time the key is pressed, the backlighting changes in the sequence of high, medium, low and off.

## 1.5 Turning the Loudspeaker On/Off

When you are using a handset and therefore do not require the internal or external loudspeaker, you can turn it off by pressing the loudspeaker [🔊/4] key. The “loudspeaker off mark” (🔊) appears.

## 1.6 Turning the Squelch On/Off

The squelch mutes the audio output in the absence of an incoming signal. Each time [SQL/5] is pressed, the squelch is turned on or off. When radio noise is too jarring during stand-by condition, it may be muted by activating the squelch. “SQ” appears when the squelch function is active.

**Note:** The squelch is disabled on the class of emission TLX or FAX; “SQ” blinks.

## 1.7 Selecting Class of Emission, Turning AGC On/Off

### Selecting class of emission

The [MODE/1] key selects the class of emission. Each time the key is pressed, the class of emission changes in the sequence of LSB, J3E, H3E, TLX (J2B) and FAX (F3C).

<u>Indication</u>	<u>Symbol</u>	<u>Class of Emission</u>
LSB*	J3E	Single Sideband radiotelephony(LSB)
J3E	J3E	Single Sideband radiotelephony(USB)
H3E	H3E	Equivalent to AM radiotelephony. Only at 2182 kHz for transmitting, any frequency for receiving.
TLX*	J2B	Radio Telex
FAX*	F3C	Reception of weather facsimile broadcast

\* Available with system setting by FURUNO authorized service agent.

## Turning AGC on/off

AGC is automatically turned on when frequency is changed, and “AGC” appears when AGC is active. To turn AGC on or off manually, press the [MODE/1] key while pressing and holding down the [ENT] key.

## 1.8 Selecting Frequency

Frequency can be selected by:

- Direct key entry (Free selection within marine bands for ship stations where a qualified Radio Operator is available.)
- Channel number entry
- [FREQ/CH] control

A receiving frequency can be selected by one of the above methods, but there is a restriction in selecting a transmitting frequency. This depends on how the equipment is programmed according to the national radio regulation.

Frequencies are indicated by:

Voice frequencies: Designated by the **CARRIER** frequency. Assigned frequencies are 1.4 kHz higher than the carrier frequencies.

Telex, DSC: Designated by the **CENTER** frequencies.

<b>TX Freq Selection</b>	<b>Setting</b>
Free selection	NO
ITU channels	All channels in the APPENDIX indicated by CH and frequency.
User channels	YES, indicated by CH/station name. Preset by FURUNO agent.

## Direct frequency entry

Rx frequency may can be entered manually. (Tx frequency may also be entered where permitted.)

### Rx frequency

To set for a receive frequency of 1636.4 kHz, for example;

Press [RX], [1], [6], [3], [6], [4], [ENT] in this order. Entry of the decimal point is not required.

### Tx frequency

To set for a transmit frequency of 2061.4 kHz, for example;

Press [TX], [2], [0], [6], [1], [4], [ENT].

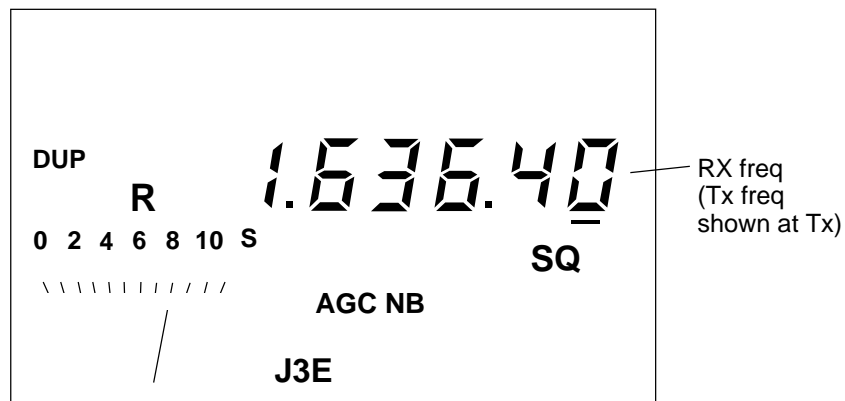

Figure 1-4 Sample frequency display

- The [CURS/2] key shifts the cursor among last 4 places (J3E) or two places to left of decimal and one place to right of decimal (H3E).
- To modify a value at a particular digit (Rx frequency only), use the [FREQ/CH] control; it changes the value above the cursor.

### Paired Rx/Tx frequency

To set for 2161 kHz simplex channel, for instance, press as below;

[TX]\*, [RX]\*, [2], [1], [6], [1], [0], [ENT]

*Do not forget to enter the last zero in the above example. The last numeral represents the 1/10 decimal place. Simply hitting [TX], [RX], [2], [1], [6], [1], [ENT] will set 216.1 kHz.*

\* Order of pressing may be reversed, that is, you may press [RX] first.

## User channels

You can recall user channels through the keyboard by channel numbers. Once a channel is selected with the keyboard, the channel can be changed with the [FREQ/CH] control.

For how to write user channels, see Chapter 3. 199 user channels ( 0-01 to 0-99 and 1-00 to 1-99) can be programmed in addition to ITU channels.

To call the channel 1-20, for example:

### Tx only

Press [TX], [CH], [1], [2], [0], [ENT]

### RX only

Press [RX], [CH], [1], [2], [0], [ENT]

### TX and RX paired

Press [CH], [1], [2], [0], [ENT]

**Note:** The standard sets provide readout of Rx CH No. and Rx frequency in kHz. When transmitting, Tx CH and Tx freq. are displayed. Pressing the [ENT] key displays both Tx and Rx frequencies.

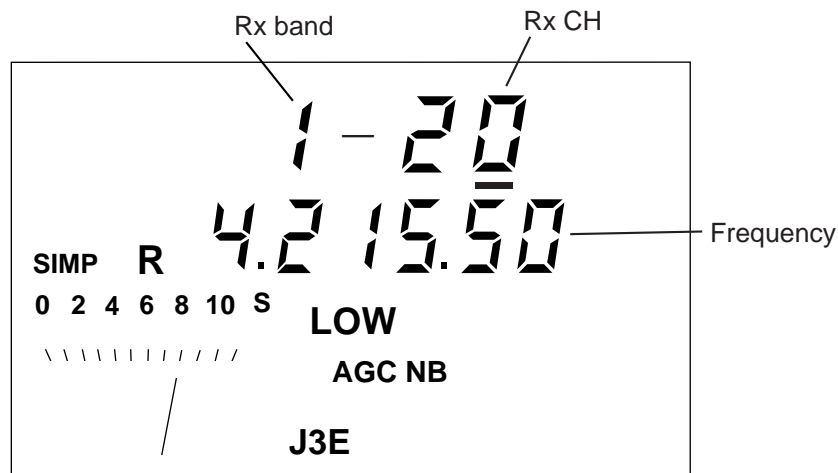

Figure 1-5 Sample user channel (Rx)

- The [CURS/2] key shifts the cursor to band or channel number.
- To change channel number use the [FREQ/CH] control; it changes the number above the cursor, a band or channel designator.
- The [ENT] key temporarily displays both Tx and Rx frequencies.

## ITU telephony channels (SSB)

To recall ITU SSB channel 412, for example, select J3E with the [MODE/1] key.

Press [CH], [4], [1], [2], [ENT], and a combination of Tx frequency of 4098 kHz and Rx frequency of 4390 kHz is selected. To select only Rx or Tx frequency, hit [RX] or [TX] first.

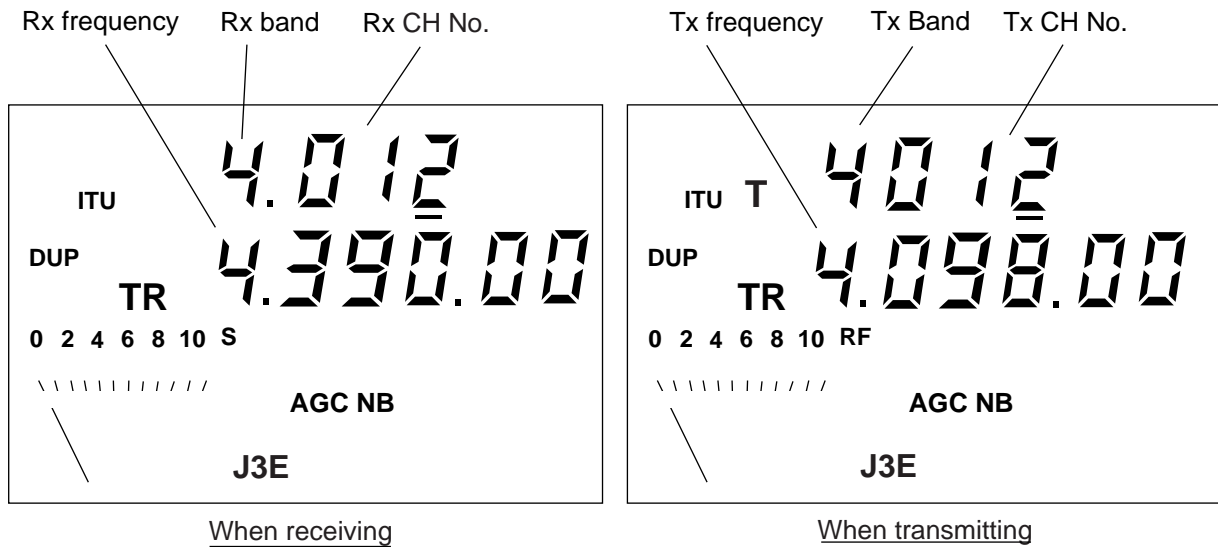

*Figure 1-6 Sample displays of ITU telephony channel*

- The [CURS/2] key shifts the cursor to band or channel number.
- To change channel number use the [FREQ/CH] control; it changes the number above the cursor, a band or channel designator.
- The [ENT] key temporarily displays both Tx and Rx frequencies.

## ITU TELEX channels

To select the ITU TELEX channel 4012, for example, first select TLX with the [MODE/1] key. This radiotelephone is furnished with J2B class of emission. The J2B is compatible with F1B which may be used on other parties. You do not have to worry about F1B or J2B; you can just select TELEX mode for narrow-band direct-printing.

Press [CH], [4], [0], [1], [2], [ENT], and a combination of TX frequency of 4178.0 kHz and RX frequency of 4215.5 kHz is selected with the display as below. To select only RX or TX frequency, hit [RX] or [TX] to begin.

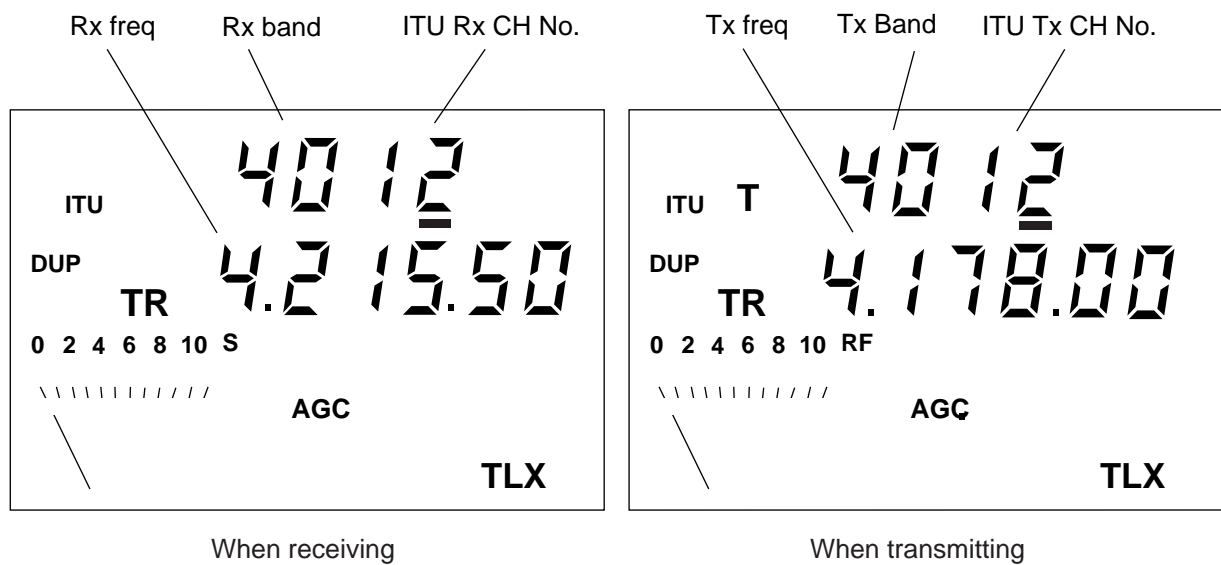

Identify frequencies by referring to the APPENDIX. Entering 412 reads 4012 as above. Tx and Rx frequencies can be read temporarily.

*Figure 1-7 Sample display of ITU telex channel*

- The [CURS/2] key shifts the cursor to band or channel number.
- To change channel number use the [FREQ/CH] control; it changes the number above the cursor, a band or channel designator.
- The [ENT] key temporarily displays both Tx and Rx frequencies.
- You can recall an ITU channel by entering 3 or 4 digits. To recall ITU telex channel 4012 by three digits, for example, select “TLX” then enter 412 (instead of 4012).
- Tx frequency/Rx frequency or Tx CH/Rx CH indication can be selected through the system settings. Ask your dealer.

## 1.9 Displaying Station Name

User channels 0-01 to 0-65 can be registered with a name, and it or the Rx frequency can be displayed on the second line of the display. This function is available when a system setting is set to display both channel and frequency. See page 3-3 for how to register station name.

1. Press [ENT] and [CURS/2] keys together. Each time those keys are pressed together, Rx frequency or station name is displayed on the second line of the display.
2. When station name is displayed, you may press the [ENT] key to display Tx and Rx frequency temporarily.

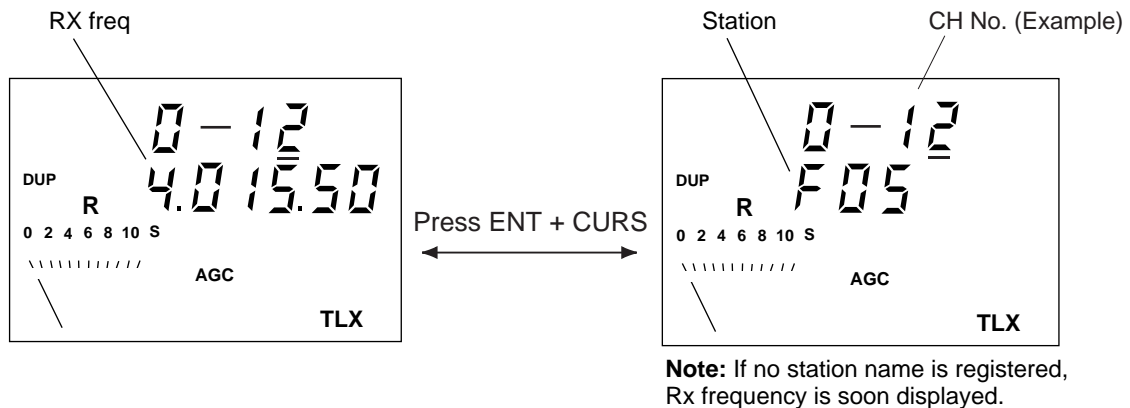

Figure 1-8 How to display Rx frequency and station name alternately

## 1.10 Transmitting

After selecting class of emission and frequency, you can transmit by pressing the PTT (press-to-talk) switch on the microphone (handset). ("T" appears when the PTT switch is pressed. Output power can be evaluated on the operation display. **Do not transmit any signal other than emergency during the silence period, 00 to 03 min, and 30 to 33 min of every hour.**

### Tuning the antenna

Maximum transmission power is achieved only when the antenna impedance and transmitter impedance match each other. Because the antenna impedance changes with frequency a means must be provided to match (tune) the antenna impedance with the transmitter impedance. This is done with the antenna coupler. The antenna coupler automatically tunes the transmitter to a wide range of different antenna length (6 – 15 m). To initiate the automatic tuning, do the following:

1. Press the PTT switch on the microphone (handset), or the [TUNE/7] key.
2. "TUNE" appears on the display.
3. Tuning will be completed within 2 to 15 seconds for a newly selected frequency, or less than 0.5 seconds for a once tuned frequency. (A built-in memory remembers coil and capacitor settings.)
4. When the tuning process is successfully completed "OK" appears.

## Using the microphone

Hold the microphone close to your mouth, press the PTT switch and speak clearly.

## Monitoring transceiver output power

The meter shows TX filter output level.

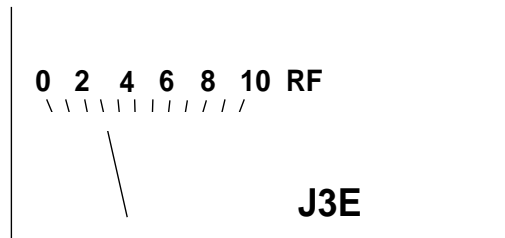

*Figure 1-9 Meter*

## Reducing transmitter power

To conserve energy and to minimize possible interference to other stations, reduce the transmission power. This should be done when using the transceiver in a harbor, near the shore or close to communication partner (other ship). Each pressing of the [H/L /8] key selects high or low output power. “LOW” appears on the display when low output power is selected. The output power on 2182 kHz (distress and calling) is the rated maximum regardless of the position of the [H/L /8] key.

## 1.11 Distress Call on 2182 kHz

The frequency 2182 kHz is an International radiotelephony distress, urgency and safety frequency for ship stations, public and private coast stations, and survival craft stations. It is also used for call and reply by ship stations on a primary basis and by public coast stations on a secondary basis.

Distress or emergency call is generally initiated by a radiotelephone alarm signal on 2182 kHz. Watch keeping receivers on other parties will hear your call.

1. Press the [2182] key. 2182 kHz and the class of emission H3E is automatically selected (J3E may be selected depending on system setting).

When the [2182] key is pressed, the following parameters are set automatically:

AGC: ON  
Output power: Maximum  
Loudspeaker: ON  
Squelch: OFF



2. While pressing and holding down the [ALM] key, press the [ENT] key. The alarm signal, modulated at 1300 Hz and 2200 Hz tones alternately, is emitted at full power for 45 sec.

The alarm can be monitored from the loudspeaker. The alarm may be canceled at any time by pressing the [ENT] key for immediate speech transmission.

### 3. Distress calls and Distress message

- (1) Speak slowly and distinctly, “MAYDAY, MAYDAY, MAYDAY, pronounced as the French expression “m’aider”.
- (2) This is;
- (3) The name of your vessel and call sign three times.

Then, continue with the distress message, which consists of:

- (1) The distress signal MAYDAY;
  - (2) The name of the mobile station in distress;
  - (3) Particulars of its position (in latitude and longitude)
  - (4) The nature of the distress;
  - (5) The kind of assistance desired;
  - (6) Any other information which might facilitate rescue, for length, color, and type of vessels, number of persons on board.
4. Indicate the end of message by saying “Over.”
  5. When you receive no answer to a distress message, repeat at intervals over again the radio-telephone alarm signal, the distress call and the distress message.

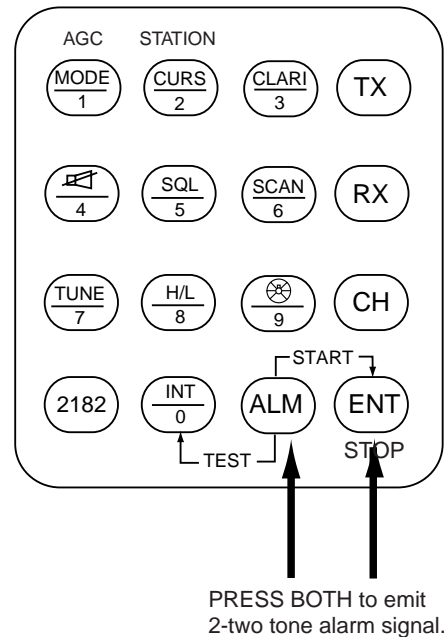

Figure 1-10 Keyboard

## Distress frequencies

All distress frequencies including 2182 kHz are shown below:

Telephony SSB (kHz, Carrier)	DSC (kHz, Center)	Telex (kHz, Center)
2 182	2 187.5	2 174.5
4 125 <ITU 421>	4 207.5	4 177.5
6 215 <ITU 606>	6 312	6 268
8 291 <ITU 833>	8 414.5	8 376.5
12 290 <ITU 1221>	12 577	12 520
16 420 <ITU 1621>	16 804.5	16 695

For other Telex frequencies, refer to APPENDIX.

## 1.12 Receiving

You can select a receiving frequency by one of the following methods:

- Direct frequency entry, or
- Channel number entry

### Adjusting RF gain

In normal use the [RF GAIN] control should be set for maximum. If the audio on the received channel is unclear or interfered with other signals, adjust (usually reduce) the control to improve clarity.

### Clarifier adjustment

If reception is unclear, try to clarify the signal as follows. For manual entry of frequency, simply turn the [FREQ/CH] control for fine tuning.

1. Press the [CLARI/3] key. (If a frequency is selected by CH No., the cursor which was located at the channel number, moves under the 10 Hz place and “CLAR” appears on the display.)
2. Turn the [FREQ/CH] control to fine tune the receiver on the wanted frequency.
3. To terminate this operation, press the [CLARI/3] key again. The cursor returns to the channel number.

### S-meter

During reception, the meter works as a Sensitivity Meter indicating the relative signal strength coming into the receiver front end. While in transmission, it indicates output level at the transmitter.

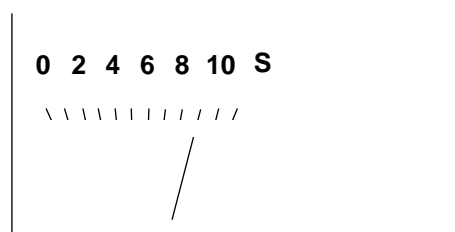

*Figure 1-11 S-meter*

**Note:** S-meter will not work with AGC off.

### Monitoring traffic on intended transmit frequency

When a semi-duplex (two-frequency simplex) channel is selected, it is recommended to monitor it if there is no existing traffic on the frequency you are going to use. To do this, press the [RX] key followed by the [ENT] key. The transceiver unit monitors traffic on the selected frequency for three sec. If you want to monitor continuously, press the [TX] key followed by the [ENT] key.

## Receiving AM broadcasting stations

1. Press the [MODE/1] key repeatedly to select H3E.
2. To tune in a 15,260 kHz shortwave station, for instance, press as below:  
[RX], [1], [5], [2], [6], [0], [0], [ENT]. **Be sure to enter the last zero.**

## Squelch control

Squelch is used to mute the receiver audio output when the receiver input is less than a preset value or dominant noise is higher than a preset (1000 Hz) frequency. To switch the squelch function ON, press the [SQL/5] key. Make sure the label “SQ” appears on the display. To pick up a weak signal at high audio frequencies, you should remove the squelch function notwithstanding a possible increase of background noise. To do this, press the [SQL/5] key again. Make sure the label “SQ” goes off.

## Noise blanker (NB)

The noise blanker clips inputs of noise resulting from an engine ignition or motor brush sparks. It can be enabled or disabled through the system settings.

# 1.13 Frequency Scan

## Channel scan

Scan is the function where the receiver watches 10/group user or ITU channels in succession at predetermined intervals. The scan-stop signal level and scan-stop time can be changed on system codes 9951 and 9952, respectively. AGC is automatically turned on when scanning is activated.

1. Recall user or ITU channel.

### User channels

User channels are divided into 20 groups in the scan mode as below.

Scan Group	User Channel No.
1	0-01 to 0-09
2	0-10 to 0-19
3	0-20 to 0-29
4	0-30 to 0-39
5	0-40 to 0-49
6	0-50 to 0-59
7	0-60 to 0-69
8	0-70 to 0-79
9	0-80 to 0-89
10	0-90 to 0-99
11	1-00 to 1-09
12	1-10 to 1-19
13	1-20 to 1-29
14	1-30 to 1-39
15	1-40 to 1-49
16	1-50 to 1-59
17	1-60 to 1-69
18	1-70 to 1-79
19	1-80 to 1-89
20	1-90 to 1-99

*Figure 1-12 Scan groups*

## ITU channels

To select the scan group (band or channel, including user channels), shift the cursor to either the position of the band or channel number by pressing the [CURS/2] key. (Band scan is useful to watch frequencies on the same channel in different bands.)

2. Press the [SCAN/6] key, and “SCAN” appears. The receiver starts scanning, stopping at a channel where the signal is stronger than the scan-stop level. The receiver will restart scanning when the traffic goes out of that channel or designated time elapses, depending on system setting 9952.

For example, the scan group is “channel” and scan starts at ITU 1203, as shown in Figure 1-12.

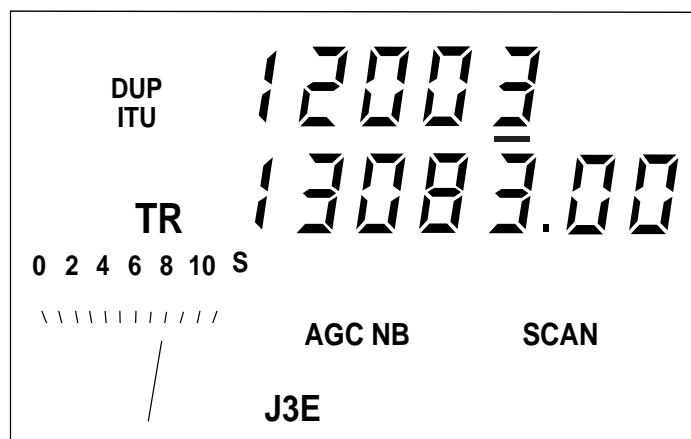

Figure 1-12 Sample “scan” screen

3. To stop scanning, press the [SCAN/6] key. “SCAN” disappears from the operation display.

## 1.14 Frequency Sweep

Sweep is the function where the receiver searches for a signal within a selected frequency coverage. AGC is automatically turned on in frequency sweep.

The defaults of respective parameters are as follows:

Sweep stop signal level:	3
Sweep stop time:	2 sec
Sweep width:	100 kHz
Step frequency:	1 kHz

These can be adjusted on system codes 9951 through 9954.

**Note:** Sweep width is the frequency width to sweep on both sides of the selected frequency. Sweep step is the frequency interval at which the receiver sweeps the sweep width.

### Procedure

1. Select the sweep center by key operation.
2. Press the [SCAN/6] key. "SWEEP" appears and the receiver starts sweeping. To stop sweeping, press the [SCAN/6] key.

## 1.15 MIF Commands

The FS-1503 can be remotely controlled by the FURUNO external device, for example, NBDP Terminal, DSC Terminal, Remote Station, with MIF commands. The table below shows the applicable MIF commands.

*Table 1-1 MIF commands applicable to the FS-1503*

<b>Command</b>	<b>Operation</b>
DRS	Locks keyboard. This command has priority over 1503's 2182 kHz.
DRR	Unlocks keyboard.
FZS	Locks keyboard. FS-1503's 2182 kHz setting has priority.
FZR	Unlocks keyboard.
EMx	Class of emission. x=Single digit denoting class of emission (0: LSB, 1: J3E, 2: H3E, 5: TLX, 6: FAX).
FTxxxxxxx	Tx frequency. x=7-digit frequency from 10 MHz to 10 Hz.
FRxxxxxxx	Rx frequency. x=7-digit frequency from 10 MHz to 10 Hz.
STxxxx	Registers set class of emission and Rx/Tx frequency as user channel. x=4-digit user channel.
CHxxxx	Sets user channel. x=4-digit band and channel.
RCxxxx	Same as above.
CHIxxxxx	Sets ITU channel x=5-digit band and channel number composed of 2-digit band and 3-digit channel.
RCIxxxxx	Same as above.
AGS	Activates AGC.
AGR	Deactivates AGC.
RFxx	Sets RF GAIN. x=FF: RF GAIN MAX., 00: RF GAIN MIN.
SQS	Activates squelch.
SQR	Deactivates squelch.
SCS	Starts scanning.
SCR	Stops scanning.
POx	Sets output power. x=0, 1, 2: LOW, 3: HIGH
TU	Tunes antenna coupler. *: tuning successful, ?: tuning error.
ICxS	Calls on intercom. x=Calling number.
ICxR	Stops call on intercom. x=Calling number.
CAID	Confirms equipment name. #IDFS1503 is returned.
CAEM	Confirms class of emission. #EM is returned.
CAFT	Confirms Tx frequency. #FTxxxxxxx is returned.
CAFR	Confirms Rx frequency. #FRxxxxxxx is returned.
CACH	Confirms channel. #CHxxxx, #CHIxxxxx is returned.
CARC	Confirms channel. #RCxxxx, #RCIxxxxx is returned.
CAAG	Confirms AGC state. #AGS: ON, #AGR: OFF
CARF	Confirms RF GAIN state. #RFxx (xx = 00-FF) is returned.
CASL	Confirms signal level. #SLxx (xx = 00-FF) is returned.
CASQ	Confirms squelch state. #SQS: ON, #SQR: OFF
CAPO	Confirms Tx output power. #POx is returned.

# 2. OPERATION OF OPTIONAL EQUIPMENT

## 2.1 Telex Communication

Telex communication is performed with a Narrow-band direct-printing (NBDP) Terminal connected with an SSB transceiver. The recommended terminal for the FS-1503 is the FURUNO DP-5/DP-6. Other makes can also be connected with the FS-1503, provided they comply with the interfacing requirements. Telex operation requires the REMOTE-A Board (option). Note that an Rx narrow filter (option) is also available.

### FURUNO NBDP Terminal DP-5/DP-6

No special operation is required; class of emission and frequencies are automatically set on the DP-5/DP-6.

Other makes of NBDP Terminal:

1. Select “TLX” with the [MODE/1] key.
2. Select a desired frequency.
3. Tune the antenna coupler by pressing the [TUNE/7] key.

Distress frequencies for telephony and telegraphy are as below. For other traffic frequencies, refer to APPENDIX.

<b>Telephony SSB (kHz, Carrier)</b>	<b>DSC (kHz, Center)</b>	<b>Telex (kHz, Center)</b>
2182	2187.5	2174.5
4125	4207.5	4177.5
6215	6312.0	6268.0
8291	8414.5	8376.5
12290	12577.0	12520.0
16420	16804.5	16695.0



## **2.2 Remote Station RB-500 (requires optional Remote-B Board)**

### **Priority**

The Remote Station RB-500 usually has higher priority than the FS-1503. This means that operation of the FS-1503 is disabled when the handset of the RB-500 is picked up. The indication “REM” appears on the FS-1503 display when the remote station is in operation and the PTT switch on the microphone of the FS-1503 is inoperative.

### **Communication on 2182 kHz**

When 2182 kHz is selected on the FS-1503, the FS-1503 takes priority.

## **2.3 Intercom**

The intercom provides communications between the FS-1503 and the RB-500 Remote Station (option). They must be wire-connected. When intercom mode is in use, there is no radio transmission.

### **Calling RB-500**

1. Press the [INT/0] key. “COM” appears on the FS-1503 display panel.
2. Press [1]\*, [ENT] keys. Calling beeps sound at the FS-1503. The buzzer stops when the handset of the RB-500 is picked up. \* Designated number of the RB-500 if more than one is installed.
3. Press the PTT switch to talk. Release the switch to listen.

### **Call from RB-500**

When the FS-1503 is called from the RB-500, the FS-1503 releases a buzzer. Press the [INT/0] key to silence the buzzer. Press the PTT switch to talk. Release the switch to listen. Note that the loudspeaker on the FS-1503 is automatically turned on when a call from the RB-500 is received, regardless of setting.

### **Terminating the intercom**

Press the [INT/0] key to terminate the intercom function. “COM” disappears.

# 3. CHANGING SYSTEM SETTINGS

## 3.1 System Setup

1. While pressing and holding down the [CH] key, turn on the power. Release the [CH] key when “MEMO” appears on the display.

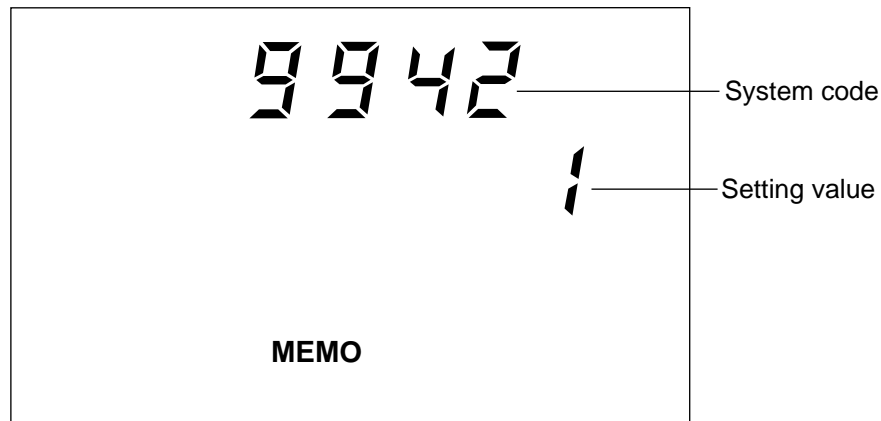

*Figure 3-1 System setting selection screen*

2. Turn the [FREQ/CH] control to select a desired code number.
3. Press the [CH] key, enter desired setting by a numeric key, then press the [ENT] key.
4. To change setting for another code, repeat steps 2 and 3.
5. Reset the power.

## 3.2 Customizing by User

The operator can customize several system settings. The table below shows the system codes and their function, setting range and factory setting.

**Note:** FURUNO Electric Company will assume no responsibility for the inconvenience or disturbance to communications due to inadequate or unlawful presetting of this equipment.

<u>Code</u>	<u>Function, Setting</u>
9942	Key beep ON/OFF A beep sounds when a keying sequence is correctly executed. You may turn the beep on or off. Factory setting: ON
9943	Noise blanker ON/OFF The noise blanker cancels unwanted noise. Factory setting: ON

- 9951 Scan/sweep-stop signal level  
When the receiver detects a signal whose level is stronger than the preset level it stops scanning and receives the signal. The setting on system code 9955 is available only when “0” (SQ working condition) is selected here.  
Setting range: 0 (Squelch working condition is effective as set on code 9955), 1-10 (S-meter level); Factory setting: 3
- 9952 Scan/sweep-stop time  
When a signal is detected, the receiver stops scanning/sweeping and dwells on this channel frequency. When “0” (RX) is selected, the receiver keeps receiving until the traffic goes out of this channel frequency. Define the dwell time between 1 and 99 sec.  
Setting range: 0 (RX), 1-99 sec; Factory setting: 2
- 9953 Sweep width setting range: 0.01-30000.00 kHz; Factory setting: 100.0
- 9954 Sweep step frequency  
Setting range: 0.01-30000.00 kHz; Factory setting: 1.00
- 9955 Squelch activation  
“Squelch activation” is the method by which the squelch is activated.  
Setting range: 0, 1, 2, 3; Factory setting: 3
- 0: Voice  
The squelch is opened by signal frequency less than 1000 Hz (factory setting). This frequency can be changed between 500 – 2000 Hz on system code 9958. The loudspeaker reproduces a sound when the signal is lower than the preset frequency.
- Squelch OPEN:  
Audio signal is detected and a sound is reproduced through the loudspeaker.
- Squelch CLOSED:  
No input signal but only noise is coming into the receiver. The receiver is muted.
- 1: Level  
The squelch is activated depending on “signal strength”. The factory setting is “5”. You can change the level between 0 - 10 on system code 9956.
- 2: And  
The squelch opens when both “voice” and “signal strength” meet the setting.
- 3: Or  
The squelch opens by either “voice” or “signal strength”, whichever meets the setting.
- 9956 Squelch level. Setting range: 0-10; Factory setting: 5

- 9957 Squelch delay - a delay until the squelch mutes (closes) the receiver after the signal has gone.  
(Ex) 9957: 1000 ms  
Squelch closes 1000 ms after the signal has gone.  
Setting range: 500-4000 ms; Factory setting: 1000 ms
- 9958 Squelch activating frequency  
Setting range: 500-2000 Hz; Factory setting: 1000 Hz

### 3.3 Writing User Channels

The user channels may write user Tx channels. (Rx channels may also be written where permitted.)

1. Turn on the power while pressing the [CH] key. Release the key when MEMO appears.
2. Rotate the [FREQ/CH] control clockwise to display desired channel no. "R" appears (Rx frequency writing mode).
4. Press the [MODE/1] key to select class of emission.
5. Press the [CH] key. Key in Rx frequency with the numeric keys (0-9) and press the [ENT] key. If you are only writing Rx frequency go to step 8.
6. Rotate the [FREQ/CH] control clockwise. "T" appears (Tx frequency writing mode).
7. Enter Tx frequency like you entered Rx frequency.
8. Rotate the [FREQ/CH] control clockwise. If no station name have been written you will see seven dashes. If station name cannot be entered for a particular station, the next channel number appears.
9. Press the [CH] key to enter station name or write over existing name. The cursor appears. A station name may consist of seven characters, hyphens, alphabet, numerics and spaces are available.
10. Operate the [FREQ/CH] control to display character desired and press the [ENT] key. To enter a space or shift the cursor press the [ENT] key. To erase station name, press [CH], [0] and [ENT]. When seven characters are entered, the cursor disappears.
11. Turn off the power to register channels.

## 4. MAINTENANCE



### WARNING

**Do not open the equipment.**

Improper handling can result in electrical shock. Only qualified personnel should work inside the equipment.

**Do not disassemble or modify the equipment.**

Fire, electrical shock or serious injury can result.

### 4.1 Weekly Checks

Check the radiotelephone at appropriate intervals as required by Administration.

#### Aural testing

1. Press the [ALM] key to generate the alarm. Confirm that the two-tone alarm is released for more than 30 seconds. You will hear the audio from the loudspeaker. This process helps to verify that the radiotelephone alarm generator is in the working condition without transmitting an actual radio signal.
2. To terminate test, press the [ALM] key again or [ENT] (STOP) key.

#### Testing the transmitter with a dummy antenna

This requires the optional dummy load (in the antenna coupler).

1. While pressing and holding down the [ALM] key, press the [INT/0] key. The dummy antenna in the antenna coupler is connected to the FS-1503 instead of the antenna. "DUMMY" appears and the test signal at test frequency (for example, 2191 kHz), modulated by two tones (1300 Hz and 2200 Hz), is generated across the dummy load for 45 seconds.
2. To stop the emission, press the [ALM] key. The dummy load is disconnected and the transceiver restores the previous frequency setting.

## 4.2 Diagnostic Test

This test checks the transceiver for proper operation. It should be conducted regularly to ensure proper operation. If a DSC or NBDP terminal is connected, the test should be conducted together with them. Before starting the test, set the RF GAIN control to maximum (fully clockwise).

1. While pressing and holding down the [TX] key, turn on the power. All LCD segments appear.
2. Release the [TX] key. The FS-1503 starts diagnostics and the following indications appear:

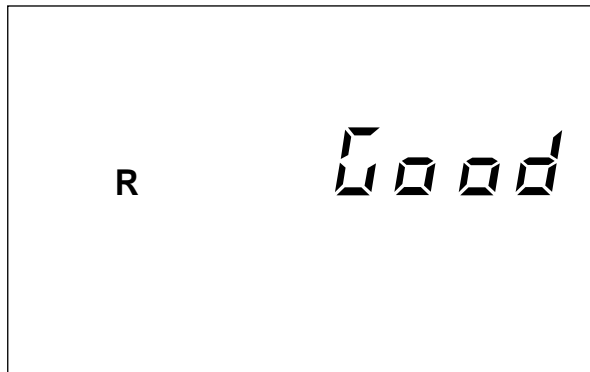

Receiver section tested successfully.

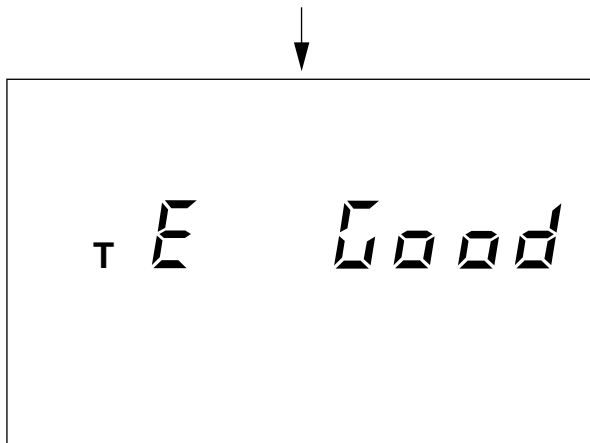

Transmitter Exciter stage is tested successfully.

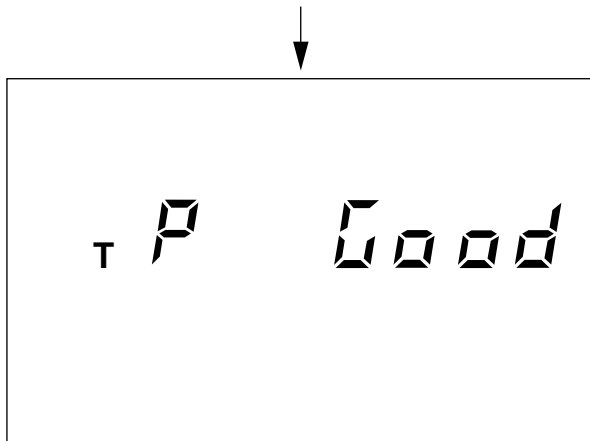

Transmitter Power Amplifier stage and Antenna Coupler are tested successfully. Test available with dummy load and by setting system setting 9917 to 1.

*Figure 4-1 Sequence of diagnostic test*

If a fault is detected, “no Good” appears instead of “Good” and the associated indication blinks after completion of this test.

3. Turn off the transceiver on completion of tests. Turn it on again for normal operation.

## 4.3 LCD/Keyboard Test & ROM Version No. Confirmation

1. While pressing and holding down the [ENT] key, turn on the power. All LCD segments appear.
2. Release the [ENT] key.
3. Press keys one by one. Check if the indication on the operation display is correct as shown below:

*Table 4-1 Key and corresponding indication*

Key	MODE/1	CURS/2	CLARI/3	TX
Indication	0	1	2	3
Key	⏏/4	SQL/5	SCAN/6	RX
Indication	4	5	6	7
Key	TUNE/7	H/L /8	⊗/9	CH
Indication	8	9	A	b
Key	2182	INT/0	ALM	ENT
Indication	c	d	E	F

Example: The [CURS/2] key is pressed. The following appears. In a few seconds, 7 characters x 2 lines readout changes to all 8.

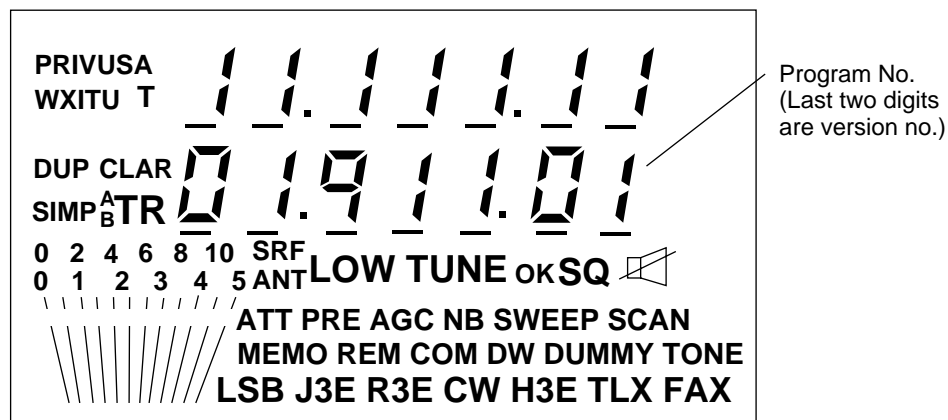

*Figure 4-2 LCD segments*

3. Turn off the transceiver on completion of tests. Turn it on again for normal operation.

## 4.4 Maintenance

This radiotelephone equipment is designed and manufactured to provide years of intended performance. For this, a regular maintenance program should be established and should at least include the items listed in the table below:

*Table 4-2 Maintenance*

<b>Item</b>	<b>Check Point</b>	<b>Remedy/Remarks</b>
Whip antenna	Check for physical damage, corrosion and water leakage.	Replace damaged parts.
Wire antenna	Check that antenna is properly spanned and separated sufficiently apart from metallic structures.	If necessary, re-span the antenna.
Insulators for antenna installation	Check for salt water accumulation on insulators.  Check that connection at lead-in insulator is tight and rust-free.	Replace damaged insulators. Remove salt water deposits. Clean with fresh water, then dry. Remove rust, then tighten bolts and lock nuts. Cover metallic surface with sealing compound.
Antenna coupler	Check contact at * Antenna terminal * Ground connection * Coaxial cable * Control cable (terminal board)  Check that coupler lid and cable glands are firmly secured.  Check for physical damage, corrosion and salt water deposits.	Tighten loosened connections.  Fasten lid firmly and evenly to prevent water leakage.  Replace if damaged.
Transceiver	Check contact at * Antenna cable * Ground connection * Power cable * Control cable  Confirm that there are no objects on the top of the cabinet.	Tighten loosened connections; remove foreign material from connectors.  Remove objects to prevent overheating.
Power supply	Check that supply voltage at transmission is within the rated range. (10.8-15.6 VDC at the power connector)	If not within the range, call for service. Low voltage may cause erratic operation.

*(Continued on next page)*



*Table 4-2 Maintenance (con't)*

<b>Item</b>	<b>Check Point</b>	<b>Remedy/Remarks</b>
Power cable	Check for loosened or corroded connection at power terminals.	Clean and tighten.
Battery	Check that the battery is fully charged.	If discharged, charge.
Feeder (coax cable, control cable)	Check for physical damage.	Replace if damaged.
PCB connection	Check that jumper cables between boards are firmly connected.	Reconnect loosened connections of jumper cables.
Microphone	Check that jumper cables between boards are firmly connected.	Fasten if loosened.

# 5. TROUBLESHOOTING

## **WARNING**

**Do not open the equipment.**

Improper handling can result in electrical shock. Only qualified personnel should work inside the equipment.

**Do not disassemble or modify the equipment.**

Fire, electrical shock or serious injury can result.

## 5.1 Troubleshooting List

The troubleshooting list below gives common symptoms of equipment malfunction and means to restore normal operation. If you cannot restore normal operation, please do not check inside any unit. Any repair is best left to a qualified radiotelephone technician. Improper handling or adjustment may cause more serious damage.

*Table 5-1 Troubleshooting list*

<b>Trouble</b>	<b>Probable Cause</b>	<b>Remedy</b>
Power cannot be turned on.	The mains switchboard may be off.  DC overvoltage input.  The battery may have discharged, or poor contact at terminals.	Turn on the mains switch.  Check supply voltage. It should be less than 15 V.  Recharge battery and tighten terminal connections.
Frequency readout appears but no lamps light.	The [⊗/9] key may be off.	Operate the [⊗/9] key.
Power is on but no sound from loudspeaker.	The [≡/4] key is off.  Volume may be too low.  Squelch is on.  Reduced RF Gain.	Press the [≡/4] key.  Adjust the [VOLUME] control.  Press the [SQL/5] key if "SQ" appears on the display.  Turn the [RF GAIN] control clockwise.

*(Continued on next page)*

*Table 5-1 Troubleshooting list (con't)*

<b>Trouble</b>	<b>Probable Cause</b>	<b>Remedy</b>
Poor articulation	<p>Wrong class of emission may be in use. (For example, receiving signal in H3E mode. H3E should be used only on 2182 kHz.)</p> <p>Receiver detuned.</p>	<p>Select class of emission same as that of incoming signal.</p> <p>In Custom or ITU channel mode, press the [CLARI/3] key then fine tune frequency by the FREQ/CH control.</p>
Output power is reduced to low ("LOW" indication blinks)	Power is automatically reduced to protect against overheating due to continuous transmission.	Wait until the unit returns to normal condition. Check if fan is working properly.
Key input is not accepted.	FS-1503 is under control of external equipment.	"REM" appears when controlled by external equipment. Suspend operation of external operation.
Antenna coupler can't tune antenna.	<p>Antenna may be disconnected or shorted to ground.</p> <p>Antenna is out of tunable length.</p> <p>Poor grounding of the coupler.</p> <p>Connection cable loosened or disconnected.</p>	<p>Check antenna connection.</p> <p>Recommended length is 6 to 15 meters.</p> <p>Check coupler ground.</p> <p>Check cable.</p>
Can not tune in a broadcast station.	<p>Missing last numeral at the digit of 1 when trying to tune in the station.</p> <p>Wrong setting of MODE</p> <p>The station is off air.</p> <p>Frequency is less than 1.6 MHz, however ANT FIL is set to 1.6 to 38 MHz.</p>	<p>To tune in 9640 kHz for instance, press [RX], [9], [6], [4], [0], [0], [ENT]. Do not miss the last [0]; otherwise you will set 964.0 kHz.</p> <p>Select H3E.</p> <p>Select another frequency.</p> <p>Set ANT FIL to 0.1 to 30 MHz(Set in PA/FIL).</p>

## 5.2 Error Indication

When the FS-1503 detects a fault in the synthesizer unit (frequency unlocked), the frequency or channel number blinks.

## 5.3 Replacing Fuses

To protect the unit from overcurrent and equipment fault, two 30 A are provided in snap-in holders on the power cable. If a fuse blows, find out the cause before replacing it. If it blows again after replacement, request service.



### **WARNING**

**Use the proper fuse.**

Fuse rating is shown on the equipment.  
Use of a wrong fuse can cause equipment damage and void the warranty.

# SPECIFICATIONS

## GENERAL

Communication System	Simplex, semi-duplex
Frequency Range	1.6 to 27.5 MHz (transmit), 0.1 to 29.9 MHz (receive)
Frequency Resolution	Transmit: 100 Hz    Receive: 10 Hz
Class of Emission	J3E SSB, suppressed carrier, signal channel containing analogue information H3E SSB, full carrier, signal channel containing analogue information, telephony; when 2182 kHz is first selected, H3E is set. J2B for DSC, NBDP; SSB, suppressed carrier, signal channel containing quantized or digital information with the use of a modulating sub-carrier, telegraphy for automatic reception F3C weather facsimile, reception only
Frequency Error	±10 Hz (Both Transmitter and Receiver)
Number of Channels	Custom channels: 199 max. Programmed by FURUNO authorized service representatives (user may program Rx channels). ITU SSB/TELEX Channels as listed in the APPENDIX.  2182 kHz (single action)
Environmental	Transceiver unit: -20°C to +55°C Antenna coupler: -30°C to +70°C Relative humidity 93% at 40°C
Power Supply	13.6 VDC (+15%, -15%) Receive: 1.5 A Transmit (max.): 30 A
Radiotelephone Alarm Signal Generator	Two tones of 2200 Hz and 1300 Hz transmitted alternately.

## TRANSMITTER

Output Impedance	50 ohms
Output Power	J3E/H3E: 1.6 to 23 MHz, 150 W pep, 23 to 27.5 MHz, 75 W pep J2B: 1.6 to 23 MHz, 100 W; 23 to 27.5 MHz, 50 W pep
Tune	10 W approx.
Power Reduction	60 W approx.
Controls	Output HI/LOW, test (option)/send of two-tone alarm generator

## **ANTENNA COUPLER**

Power Capability	150 W pep
Tuning System	CPU controlled fully automatic tuning system
Frequency Range	1.6 to 27.5 MHz
Input Impedance	50 ohms (viewed from transceiver)
Antenna Required	6 to 15 meters wire or whip
Tuning Power	10 to 20 W pep
VSWR	Less than 1.5
Tuning Time	Within 2 to 15 seconds, Within 0.5 seconds for an ever tuned frequency
Dummy Load (option)	10 ohms + 250 pF for check of Two-tone alarm generator at 2191 kHz (frequency changeable)
Power Requirement	12.0 VDC, 0.6 A (supplied from transceiver)
Construction	Waterproof plastic cabinet, stainless steel mount

## **RECEIVER**

Receiving System	Double-conversion superheterodyne IF: 54.455 MHz and 455 kHz.
Sensitivity	Input level to produce SINAD 20 dB J3E J2B 1.6 - 4 MHz Below +16 dB $\mu$ V Below +6 dB $\mu$ V across 10 $\Omega$ + 250 pF 4-27.5 MHz Below +3 dB $\mu$ V Below -7 dB $\mu$ V across 50 $\Omega$
Pass Band	350 - 2700 Hz -6 dB
Cross Modulation	Unwanted signal +90 dB $\mu$ V $\pm$ 20 kHz from +60 dB $\mu$ V wanted signal
Audio Output	1 W (8 $\Omega$ internal loudspeaker), 3.5 W (4 $\Omega$ optional external loudspeaker) 0 dBm/600 $\Omega$ line output (for NBDP, DSC, RB-500)
Other Features	RF Gain: Adjustable Squelch: ON/OFF, Activated by voice/signal strength Dimmer: OFF/Low/Medium/High Loudspeaker: ON/OFF (Handset always alive) AGC: ON/OFF Noise blanker: ON/OFF (thru system setting)



## MF band working carrier frequencies - ref. US CFR 47 Part 80.371

Region	Ship Receive (kHz)	Ship Transmit (kHz)
East Coast	2490.0	2031.5
	2514.0	2118.0
	2522.0	2126.0
	2538.0	2142.0
	2558.0	2166.0
	2590.0	2198.0
	2450.0	2366.0
	2482.0	2382.0
	2566.0	2390.0
	2400.0	2400.0
	2506.0	2406.0
West Coast	2450.0	2003.0
	2442.0	2009.0
	2566.0	2009.0
	2566.0	2031.5
	2522.0	2126.0
	2598.0	2206.0
	2466.0	2382.0
	2482.0	2430.0

Region	Ship Receive (kHz)	Ship Transmit (kHz)
Gulf Coast	2466.0	2009.0
	2530.0	2134.0
	2538.0	2142.0
	2550.0	2158.0 <sup>1</sup>
	2558.0	2166.0
	2598.0	2206.0
	2450.0	2366.0
	2482.0	2382.0
	2572.0	2430.0
2506.0	2458.0	
Great Lakes <sup>2</sup>	2514.0	2118.0
	2550.0	2158.0
	2582.0	2206.0
Alaska	2309.0	2131.0
	2312.0	2134.0
	2400.0	2240.0
Hawaii	2530.0	2134.0
Caribbean	2506.0	2009.0
	2585.0	2086.0 <sup>3</sup>
	2530.0	2134.0
Guam	2506.0	2009.0

**Above is not factory programmed, should be programmed by Furuno representatives.**

1 Unlimited use December 15 to April 1

2 2206 kHz for distress only.

3 Limited to pep of 150 W.

**NOTE:** <sup>1</sup> to <sup>3</sup> indicate the outline only. Refer to the relative documentation for full detail. For other coast stations, consult with your dealers.



## MF band SSB working carrier frequencies

CH NO	Ship Receive (kHz)	Ship Transmit (kHz)	CH NO	Ship Receive (kHz)	Ship Transmit (kHz)
241	1635	2060	271	1725	2069
242	1638	2063	272	1728	2072
243	1641	2066	273	1731	2075
244	1644	2069	274	1734	2078
245	1647	2072	275	1737	2081
246	1650	2075	276	1740	2084
247	1653	2078	277	1743	2087
248	1656	2081	278	1746	2090
249	1659	2084	279	1749	2093
250	1662	2087	280	1752	2096
251	1665	2090	281	1755	2099
252	1668	2093	282	1758	2102
253	1671	2096	283	1761	2105
254	1674	2099	284	1764	2108
255	1677	2102	285	1767	2111
256	1680	2105	286	1770	2114
257	1683	2108	287	1773	2117
258	1686	2111	288	1776	2120
259	1689	2114	289	1779	2123
260	1692	2117	290	1782	2126
261	1695	2120	291	1785	2129
262	1698	2123	292	1788	2132
263	1701	2126	293	1791	2135
264	1704	2129	294	1794	2138
265	1707	2132	295	1797	2060
266	1710	2135			
267	1713	2138			
268	1716	2060			
269	1719	2063			
270	1722	2066			

Change of system setting required to use above channels. Ask a FURUNO dealer. Above is factory programmed. A channel can be recalled by hitting the keys [CH], [2], [4], [1], [ENT] for channel 241 as an example. The channel number and Rx frequencies appear on the display. The channel number is displayed in 4 digits, such as 2041. (Additional zero is inserted automatically.) The Tx frequency and Rx frequency are checked by pressing the [ENT] key.

## 4/6 MHz ITU SSB carrier frequencies (ITU RR APPENDIX 16)

The following frequencies are factory programmed.

4 MHz SSB (J3E)		
ITU CH NO	Ship RX	Ship TX
401	4357	4065
402	4360	4068
403	4363	4071
404	4366	4074
405	4369	4077
406	4372	4080
407	4375	4083
408	4378	4086
409	4381	4089
410	4384	4092
411	4387	4095
412	4390	4098
413	4393	4101
414	4396	4104
415	4399	4107
416	4402	4110
417	4405	4113
418	4408	4116
419	4411	4119
420	4414	4122
421	4417	4125
422	4420	4128
423	4423	4131
424	4426	4134
425	4429	4137
426	4432	4140
427	4435	4143
428	4351	4351
429	4354	4354
430	4146	4146
431	4149	4149
432 (01)	4000	4000
433 (02)	4003	4003
434 (03)	4006	4006
435 (04)	4009	4009
436 (05)	4012	4012
437 (06)	4015	4015
438 (07)	4018	4018
439 (08)	4021	4021
440 (09)	4024	4024
441 (10)	4027	4027
442 (11)	4030	4030
443 (12)	4033	4033
444 (13)	4036	4036
445 (14)	4039	4039
446 (15)	4042	4042
447 (16)	4045	4045
448 (17)	4048	4048
449 (18)	4051	4051
450 (19)	4054	4054
451 (20)	4057	4057
452 (21)	4060	4060

6 MHz SSB (J3E)		
ITU CH NO	Ship RX	Ship TX
601	6501	6200
602	6504	6203
603	6507	6206
604	6510	6209
605	6513	6212
606	6516	6215
607	6519	6218
608	6522	6221
609	6224	6224
610	6227	6227
611	6230	6230

A channel can be recalled by hitting the keys [CH], [4], [0], [1], [ENT] for CH 401 as an example.

Channel number and Rx frequency appear on the display. The CH NO is displayed in 4 digits such as 4001. To see Tx frequency and Rx frequency, press [ENT].

CH NOs in ( ) are ITU NOs (RR Section C-1). Use 3-digit FURUNO's designators for selections.

## 8 MHz ITU SSB carrier frequencies (ITU RR APPENDIX 16)

The following frequencies are factory programmed.

8 MHz SSB (J3E)		
ITU CH NO	Ship RX	Ship TX
801	8719	8195
802	8722	8198
803	8725	8201
804	8728	8204
805	8731	8207
806	8734	8210
807	8737	8213
808	8740	8216
809	8743	8219
810	8746	8222
811	8749	8225
812	8752	8228
813	8755	8231
814	8758	8234
815	8761	8237
816	8764	8240
817	8767	8243
818	8770	8246
819	8773	8249
820	8776	8252
821	8779	8255
822	8782	8258
823	8785	8261
824	8788	8264
825	8791	8267
826	8794	8270
827	8797	8273
828	8800	8276
829	8803	8279
830	8806	8282
831	8809	8285
832	8812	8288
833	8291	8291
834	8707	8707
835	8710	8710
836	8713	8713
837	8716	8716
838	8294	8294
839	8297	8297

8 MHz SSB (J3E)		
(ITU CH NO)	Ship RX	Ship TX
840 (01)	8101	8101
841 (02)	8104	8104
842 (03)	8107	8107
843 (04)	8110	8110
844 (05)	8113	8113
845 (06)	8116	8116
846 (07)	8119	8119
847 (08)	8122	8122
848 (09)	8125	8125
849 (10)	8128	8128
850 (11)	8131	8131
851 (12)	8134	8134
852 (13)	8137	8137
853 (14)	8140	8140
854 (15)	8143	8143
855 (16)	8146	8146
856 (17)	8149	8149
857 (18)	8152	8152
858 (19)	8155	8155
859 (20)	8158	8158
860 (21)	8161	8161

CH NOs in ( ) are ITU NOs (RR Section C-1).  
Use 3-digit Furuno's designators for selection in this radiotelephone.

A channel can be recalled by hitting the keys [CH], [8], [0], [1], [ENT] for channel 801 as an example. CH NO and Rx frequency appear on the display. The channel number is displayed in 4 digits, such as 8001. (Additional zero is inserted automatically.) The Tx frequency and Rx frequency are checked by pressing the [ENT] key.

## 12/16 MHz ITU SSB carrier frequencies (ITU RR APPENDIX 16)

12 MHz SSB (J3E)			16 MHz SSB (J3E)			16 MHz SSB (J3E)		
CH NO.	SHIP RX	SHIP TX	CH NO.	SHIP RX	SHIP TX	CH NO.	SHIP RX	SHIP TX
1201	13077	12230	1601	17242	16360	1651	17392	16510
1202	13080	12233	1602	17245	16363	1652	17395	16513
1203	13083	12236	1603	17248	16366	1653	17398	16516
1204	13086	12239	1604	17251	16369	1654	17401	16519
1205	13089	12242	1605	17254	16372	1655	17404	16522
1206	13092	12245	1606	17257	16375	1656	17407	16525
1207	13095	12248	1607	17260	16378	1657	16528	16528
1208	13098	12251	1608	17263	16381	1658	16531	16531
1209	13101	12254	1609	17266	16384	1659	16534	16534
1210	13104	12257	1610	17269	16387	1660	16537	16537
1211	13107	12260	1611	17272	16390	1661	16540	16540
1212	13110	12263	1612	17275	16393	1662	16543	16543
1213	13113	12266	1613	17278	16396	1663	16546	16546
1214	13116	12269	1614	17281	16399			
1215	13119	12272	1615	17284	16402			
1216	13122	12275	1616	17287	16405			
1217	13125	12278	1617	17290	16408			
1218	13128	12281	1618	17293	16411			
1219	13131	12284	1619	17296	16414			
1220	13134	12287	1620	17299	16417			
1221	13137	12290	1621	17302	16420			
1222	13140	12293	1622	17305	16423			
1223	13143	12296	1623	17308	16426			
1224	13146	12299	1624	17311	16429			
1225	13149	12302	1625	17314	16432			
1226	13152	12305	1626	17317	16435			
1227	13155	12308	1627	17320	16438			
1228	13158	12311	1628	17323	16441			
1229	13161	12314	1629	17326	16444			
1230	13164	12317	1630	17329	16447			
1231	13167	12320	1631	17332	16450			
1232	13170	12323	1632	17335	16453			
1233	13173	12326	1633	17338	16456			
1234	13176	12329	1634	17341	16459			
1235	13179	12332	1635	17344	16462			
1236	13182	12335	1636	17347	16465			
1237	13185	12338	1637	17350	16468			
1238	13188	12341	1638	17353	16471			
1239	13191	12344	1639	17356	16474			
1240	13194	12347	1640	17359	16477			
1241	13197	12350	1641	17362	16480			
1242	12353	12353	1642	17365	16483			
1243	12356	12356	1643	17368	16486			
1244	12359	12359	1644	17371	16489			
1245	12362	12362	1645	17374	16492			
1246	12365	12365	1646	17377	16495			
			1647	17380	16498			
			1648	17383	16501			
			1649	17386	16504			
			1650	17389	16507			

A channel can be recalled by hitting the keys [CH], [1], [2], [0], [1], [ENT] for channel 1201 as an example. CH NO and Rx frequency appear on the display. The CH NO is displayed in 5 digits, such as 12001. (Additional zero is inserted automatically.)

The Tx and Rx frequencies are checked by pressing the [ENT] key.

Above is factory programmed.

## 18/19, 22, 25/26 MHz ITU SSB carrier frequencies (ITU RR APPENDIX 16)

The following frequencies are factory programmed.

18/19 MHz SSB (J3E)		
CH NO.	SHIP RX	SHIP TX
1801	19755	18780
1802	19758	18783
1803	19761	18786
1804	19764	18789
1805	19767	18792
1806	19770	18795
1807	19773	18798
1808	19776	18801
1809	19779	18804
1810	19782	18807
1811	19785	18810
1812	19788	18813
1813	19791	18816
1814	19794	18819
1815	19797	18822
1816	18825	18825
1817	18828	18828
1818	18831	18831
1819	18834	18834
1820	18837	18837
1821	18840	18840
1822	18843	18843

A channel can be recalled by hitting the keys [CH], [1], [8], [0], [1], [ENT] for channel 1801 as an example. CH NO and Rx frequency appear on the display. The CH NO displayed in 5 digits, such as 18001. (Additional zero is inserted automatically.)

The Tx and Rx frequencies are checked by pressing the [ENT] key.

22 MHz SSB (J3E)		
CH NO.	SHIP RX	SHIP TX
2201	22696	22000
2202	22699	22003
2203	22702	22006
2204	22705	22009
2205	22708	22012
2206	22711	22015
2207	22714	22018
2208	22717	22021
2209	22720	22024
2210	22723	22027
2211	22726	22030
2212	22729	22033
2213	22732	22036
2214	22735	22039
2215	22738	22042
2216	22741	22045
2217	22744	22048
2218	22747	22051
2219	22750	22054
2220	22753	22057
2221	22756	22060
2222	22759	22063
2223	22762	22066
2224	22765	22069
2225	22768	22072
2226	22771	22075
2227	22774	22078
2228	22777	22081
2229	22780	22084
2230	22783	22087
2231	22786	22090
2232	22789	22093
2233	22792	22096
2234	22795	22099
2235	22798	22102
2236	22801	22105
2237	22804	22108
2238	22807	22111
2239	22810	22114
2240	22813	22117
2241	22816	22120
2242	22819	22123
2243	22822	22126
2244	22825	22129
2245	22828	22132
2246	22831	22135
2247	22834	22138
2248	22837	22141
2249	22840	22144
2250	22843	22147

22 MHz SSB (J3E)		
CH NO.	SHIP RX	SHIP TX
2251	22846	22150
2252	22849	22153
2253	22852	22156
2254	22159	22159
2255	22162	22162
2256	22165	22165
2257	22168	22168
2258	22171	22171
2259	22174	22174
2260	22177	22177

25/26 MHz SSB (J3E)		
CH NO	Ship RX	Ship TX
2501	26145	25070
2502	26148	25073
2503	26151	25076
2504	26154	25079
2505	26157	25082
2506	26160	25085
2507	26163	25088
2508	26166	25091
2509	26169	25094
2510	26172	25097
2511	25100	25100
2512	25103	25103
2513	25106	25106
2514	25109	25109
2515	25112	25112
2516	25115	25115
2517	25118	25118

# TELEX CHANNELS

## MF BAND Telex FREQUENCY TABLE

The following frequencies are factory programmed.

CH NO.	Ship Receive (NBDP, DSC)	Ship Transmit (NBDP, DSC)	
201	2142.0	1607.0	NBDP/DSC
202	2142.5	1607.5	
203	2143.0	1608.0	
204	2143.5	1608.5	
205	2144.0	1609.0	
206	2144.5	1609.5	
207	2145.0	1610.0	
208	2145.5	1610.5	
209	2146.0	1611.0	
210	2146.5	1611.5	
211	2147.0	1612.0	
212	2147.5	1612.5	
213	2148.0	1613.0	
214	2148.5	1613.5	
215	2149.0	1614.0	
216	2149.5	1614.5	
217	2150.0	1615.0	
218	2150.5	1615.5	
219	2151.0	1616.0	
220	2151.5	1616.5	
221	2152.0	1617.0	
222	2152.5	1617.5	
223	2153.0	1618.0	
224	2153.5	1618.5	
225	2154.0	1619.0	
226	2154.5	1619.5	
227	2155.0	1620.0	
228	2155.5	1620.5	
229	2156.0	1621.0	
230	2156.5	1621.5	
231	2157.0	1622.0	
232	2157.5	1622.5	
233	2158.0	1623.0	
234	2158.5	1623.5	
235	2159.0	1624.0	
236	2159.5	1624.5	

For Europe MF frequencies selection of ITU+MF on system setting necessary. A channel can be recalled by hitting the keys [CH], [2], [0], [1], [ENT] for channel 201 as an example. CH NO and Rx frequency appear on the display. The channel number is displayed in 4 digits, such as 2001. (Additional zero is inserted automatically.) The Rx and Tx frequencies are checked by pressing the [ENT] key.

**4/6 MHz BAND ITU NBDP (Telex) FREQUENCY TABLE**  
(ITU RR APPENDIX 32)

4 MHz TELEX			6 MHz TELEX			6 MHz TELEX		
CH NO.	SHIP RX	SHIP TX	CH NO.	SHIP RX	SHIP TX	CH NO.	SHIP RX	SHIP TX
4001	4210.5	4172.5	6001	6314.5	6263.0	6041	6303.5	6303.5
4002	4211.0	4173.0	6002	6315.0	6263.5	6042	6304.0	6304.0
4003	4211.5	4173.5	6003	6315.5	6264.0	6043	6304.5	6304.5
4004	4212.0	4174.0	6004	6316.0	6264.5	6044	6305.0	6305.0
4005	4212.5	4174.5	6005	6316.5	6265.0	6045	6305.5	6305.5
4006	4213.0	4175.0	6006	6317.0	6265.5	6046	6306.0	6306.0
4007	4213.5	4175.5	6007	6317.5	6266.0	6047	6306.5	6306.5
4008	4214.0	4176.0	6008	6318.0	6266.5	6048	6307.0	6307.0
4009	4214.5	4176.5	6009	6318.5	6267.0	6049	6307.5	6307.5
4010	4215.0	4177.0	6010	6319.0	6267.5	6050	6308.0	6308.0
4011	4177.5	4177.5	6011	6268.0	6268.0	6051	6308.5	6308.5
4012	4215.5	4178.0	6012	6319.5	6268.5	6052	6309.0	6309.0
4013	4216.0	4178.5	6013	6320.0	6269.0	6053	6309.5	6309.5
4014	4216.5	4179.0	6014	6320.5	6269.5	6054	6310.0	6310.0
4015	4217.0	4179.5	6015	6321.0	6270.0	6055	6310.5	6310.5
4016	4217.5	4180.0	6016	6321.5	6270.5	6056	6311.0	6311.0
4017	4218.0	4180.5	6017	6322.0	6271.0	6057	6311.5	6311.5
4018	4218.5	4181.0	6018	6322.5	6271.5	6058	6312.0	6312.0
4019	4219.0	4181.5	6019	6323.0	6272.0	6059	6331.0	6312.5
4020	4202.5	4202.5	6020	6323.5	6272.5	6060	6331.5	6313.0
4021	4203.0	4203.0	6021	6324.0	6273.0	6061	6332.0	6313.5
4022	4203.5	4203.5	6022	6324.5	6273.5			
4023	4204.0	4204.0	6023	6325.0	6274.0			
4024	4204.5	4204.5	6024	6325.5	6274.5			
4025	4205.0	4205.0	6025	6326.0	6275.0			
4026	4205.5	4205.5	6026	6326.5	6275.5			
4027	4206.0	4206.0	6027	6327.0	6281.0			
4028	4206.5	4206.5	6028	6327.5	6281.5			
4029	4207.0	4207.0	6029	6328.0	6282.0			
4030	4207.5	4207.5	6030	6328.5	6282.5			
4031	4219.5	4208.0	6031	6329.0	6283.0			
4032	4220.0	4208.5	6032	6329.5	6283.5			
4033	4220.5	4209.0	6033	6330.0	6284.0			
			6034	6330.5	6284.5			
			6035	6300.5	6300.5			
			6036	6301.0	6301.0			
			6037	6301.5	6301.5			
			6038	6302.0	6302.0			
			6039	6302.5	6302.5			
			6040	6303.0	6303.0			

Above is factory programmed.

## 8 MHz BAND ITU NBDP (Telex) FREQUENCY TABLE

(ITU RR APPENDIX 32)

8 MHz TELEX			8 MHz TELEX		
CH NO.	SHIP RX	SHIP TX	CH NO.	SHIP RX	SHIP TX
8001	8376.5	8376.5	8046	8399.0	8399.0
8002	8417.0	8377.0	8047	8399.5	8399.5
8003	8417.5	8377.5	8048	8400.0	8400.0
8004	8418.0	8378.0	8049	8400.5	8400.5
8005	8418.5	8378.5	8050	8401.0	8401.0
8006	8419.0	8379.0	8051	8401.5	8401.5
8007	8419.5	8379.5	8052	8402.0	8402.0
8008	8420.0	8380.0	8053	8402.5	8402.5
8009	8420.5	8380.5	8054	8403.0	8403.0
8010	8421.0	8381.0	8055	8403.5	8403.5
8011	8421.5	8381.5	8056	8404.0	8404.0
8012	8422.0	8382.0	8057	8404.5	8404.5
8013	8422.5	8382.5	8058	8405.0	8405.0
8014	8423.0	8383.0	8059	8405.5	8405.5
8015	8423.5	8383.5	8060	8406.0	8406.0
8016	8424.0	8384.0	8061	8406.5	8406.5
8017	8424.5	8384.5	8062	8407.0	8407.0
8018	8425.0	8385.0	8063	8407.5	8407.5
8019	8425.5	8385.5	8064	8408.0	8408.0
8020	8426.0	8386.0	8065	8408.5	8408.5
8021	8426.5	8386.5	8066	8409.0	8409.0
8022	8427.0	8387.0	8067	8409.5	8409.5
8023	8427.5	8387.5	8068	8410.0	8410.0
8024	8428.0	8388.0	8069	8410.5	8410.5
8025	8428.5	8388.5	8070	8411.0	8411.0
8026	8429.0	8389.0	8071	8411.5	8411.5
8027	8429.5	8389.5	8072	8412.0	8412.0
8028	8430.0	8390.0	8073	8412.5	8412.5
8029	8430.5	8390.5	8074	8413.0	8413.0
8030	8431.0	8391.0	8075	8413.5	8413.5
8031	8431.5	8391.5	8076	8414.0	8414.0
8032	8432.0	8392.0	8077	8414.5	8414.5
8033	8432.5	8392.5	8078	8436.5	8415.0
8034	8433.0	8393.0	8079	8437.0	8415.5
8035	8433.5	8393.5	8080	8437.5	8416.0
8036	8434.0	8394.0			
8037	8434.5	8394.5			
8038	8435.0	8395.0			
8039	8435.5	8395.5			
8040	8436.0	8396.0			
8041	8396.5	8396.5			
8042	8397.0	8397.0			
8043	8397.5	8397.5			
8044	8398.0	8398.0			
8045	8398.5	8398.5			

Above is factory programmed.



## 12 MHz BAND ITU NBDP (Telex) FREQUENCY TABLE

The following frequencies are factory programmed.

12 MHz TELEX			12 MHz TELEX			12 MHz TELEX		
CH NO.	SHIP RX	SHIP TX	CH NO.	SHIP RX	SHIP TX	CH NO.	SHIP RX	SHIP TX
12001	12579.5	12477.0	12056	12607.0	12504.5	12111	12634.0	12532.0
12002	12580.0	12477.5	12057	12607.5	12505.0	12112	12634.5	12532.5
12003	12580.5	12478.0	12058	12608.0	12505.5	12113	12635.0	12533.0
12004	12581.0	12478.5	12059	12608.5	12506.0	12114	12635.5	12533.5
12005	12581.5	12479.0	12060	12609.0	12506.5	12115	12636.0	12534.0
12006	12582.0	12479.5	12061	12609.5	12507.0	12116	12636.5	12534.5
12007	12582.5	12480.0	12062	12610.0	12507.5	12117	12637.0	12535.0
12008	12583.0	12480.5	12063	12610.5	12508.0	12118	12637.5	12535.5
12009	12583.5	12481.0	12064	12611.0	12508.5	12119	12638.0	12536.0
12010	12584.0	12481.5	12065	12611.5	12509.0	12120	12638.5	12536.5
12011	12584.5	12482.0	12066	12612.0	12509.5	12121	12639.0	12537.0
12012	12585.0	12482.5	12067	12612.5	12510.0	12122	12639.5	12537.5
12013	12585.5	12483.0	12068	12613.0	12510.5	12123	12640.0	12538.0
12014	12586.0	12483.5	12069	12613.5	12511.0	12124	12640.5	12538.5
12015	12586.5	12484.0	12070	12614.0	12511.5	12125	12641.0	12539.0
12016	12587.0	12484.5	12071	12614.5	12512.0	12126	12641.5	12539.5
12017	12587.5	12485.0	12072	12615.0	12512.5	12127	12642.0	12540.0
12018	12588.0	12485.5	12073	12615.5	12513.0	12128	12642.5	12540.5
12019	12588.5	12486.0	12074	12616.0	12513.5	12129	12643.0	12541.0
12020	12589.0	12486.5	12075	12616.5	12514.0	12130	12643.5	12541.5
12021	12589.5	12487.0	12076	12617.0	12514.5	12131	12644.0	12542.0
12022	12590.0	12487.5	12077	12617.5	12515.0	12132	12644.5	12542.5
12023	12590.5	12488.0	12078	12618.0	12515.5	12133	12645.0	12543.0
12024	12591.0	12488.5	12079	12618.5	12516.0	12134	12645.5	12543.5
12025	12591.5	12489.0	12080	12619.0	12516.5	12135	12646.0	12544.0
12026	12592.0	12489.5	12081	12619.5	12517.0	12136	12646.5	12544.5
12027	12592.5	12490.0	12082	12620.0	12517.5	12137	12647.0	12545.0
12028	12593.0	12490.5	12083	12620.5	12518.0	12138	12647.5	12545.5
12029	12593.5	12491.0	12084	12621.0	12518.5	12139	12648.0	12546.0
12030	12594.0	12491.5	12085	12621.5	12519.0	12140	12648.5	12546.5
12031	12594.5	12492.0	12086	12622.0	12519.5	12141	12649.0	12547.0
12032	12595.0	12492.5	12087	12520.0	12520.0	12142	12649.5	12547.5
12033	12595.5	12493.0	12088	12622.5	12520.5	12143	12650.0	12548.0
12034	12596.0	12493.5	12089	12623.0	12521.0	12144	12650.5	12548.5
12035	12596.5	12494.0	12090	12623.5	12521.5	12145	12651.0	12549.0
12036	12597.0	12494.5	12091	12624.0	12522.0	12146	12651.5	12549.5
12037	12597.5	12495.0	12092	12624.5	12522.5	12147	12652.0	12550.0
12038	12598.0	12495.5	12093	12625.0	12523.0	12148	12652.5	12550.5
12039	12598.5	12496.0	12094	12625.5	12523.5	12149	12653.0	12551.0
12040	12599.0	12496.5	12095	12626.0	12524.0	12150	12653.5	12551.5
12041	12599.5	12497.0	12096	12626.5	12524.5	12151	12654.0	12552.0
12042	12600.0	12497.5	12097	12627.0	12525.0	12152	12654.5	12552.5
12043	12600.5	12498.0	12098	12627.5	12525.5	12153	12655.0	12553.0
12044	12601.0	12498.5	12099	12628.0	12526.0	12154	12655.5	12553.5
12045	12601.5	12499.0	12100	12628.5	12526.5	12155	12656.0	12554.0
12046	12602.0	12499.5	12101	12629.0	12527.0	12156	12656.5	12554.5
12047	12602.5	12500.0	12102	12629.5	12527.5	12157	12660.0	12560.0
12048	12603.0	12500.5	12103	12630.0	12528.0	12158	12660.5	12560.5
12049	12603.5	12501.0	12104	12630.5	12528.5	12159	12661.0	12561.0
12050	12604.0	12501.5	12105	12631.0	12529.0	12160	12661.5	12561.5
12051	12604.5	12502.0	12106	12631.5	12529.5	12161	12662.0	12562.0
12052	12605.0	12502.5	12107	12632.0	12530.0	12162	12662.5	12562.5
12053	12605.5	12503.0	12108	12632.5	12530.5	12163	12663.0	12563.0
12054	12606.0	12503.5	12109	12633.0	12531.0	12164	12663.5	12563.5
12055	12606.5	12504.0	12110	12633.5	12531.5	12165	12664.0	12564.0

## 12/16 MHz BAND ITU NBDP (Telex) FREQUENCY TABLE

The following frequencies are factory programmed.

12 MHz TELEX			16 MHz TELEX			16 MHz TELEX		
CH NO.	SHIP RX	SHIP TX	CH NO.	SHIP RX	SHIP TX	CH NO.	SHIP RX	SHIP TX
12166	12564.5	12564.5	16001	16807.0	16683.5	16056	16834.0	16711.0
12167	12565.0	12565.0	16002	16807.5	16684.0	16057	16834.5	16711.5
12168	12565.5	12565.5	16003	16808.0	16684.5	16058	16835.0	16712.0
12169	12566.0	12566.0	16004	16808.5	16685.0	16059	16835.5	16712.5
12170	12566.5	12566.5	16005	16809.0	16685.5	16060	16836.0	16713.0
12171	12567.0	12567.0	16006	16809.5	16686.0	16061	16836.5	16713.5
12172	12567.5	12567.5	16007	16810.0	16686.5	16062	16837.0	16714.0
12173	12568.0	12568.0	16008	16810.5	16687.0	16063	16837.5	16714.5
12174	12568.5	12568.5	16009	16811.0	16687.5	16064	16838.0	16715.0
12175	12569.0	12569.0	16010	16811.5	16688.0	16065	16838.5	16715.5
12176	12569.5	12569.5	16011	16812.0	16688.5	16066	16839.0	16716.0
12177	12570.0	12570.0	16012	16812.5	16689.0	16067	16839.5	16716.5
12178	12570.5	12570.5	16013	16813.0	16689.5	16068	16840.0	16717.0
12179	12571.0	12571.0	16014	16813.5	16690.0	16069	16840.5	16717.5
12180	12571.5	12571.5	16015	16814.0	16690.5	16070	16841.0	16718.0
12181	12572.0	12572.0	16016	16814.5	16691.0	16071	16841.5	16718.5
12182	12572.5	12572.5	16017	16815.0	16691.5	16072	16842.0	16719.0
12183	12573.0	12573.0	16018	16815.5	16692.0	16073	16842.5	16719.5
12184	12573.5	12573.5	16019	16816.0	16692.5	16074	16843.0	16720.0
12185	12574.0	12574.0	16020	16816.5	16693.0	16075	16843.5	16720.5
12186	12574.5	12574.5	16021	16817.0	16693.5	16076	16844.0	16721.0
12187	12575.0	12575.0	16022	16817.5	16694.0	16077	16844.5	16721.5
12188	12575.5	12575.5	16023	16818.0	16694.5	16078	16845.0	16722.0
12189	12576.0	12576.0	16024	16695.0	16695.0	16079	16845.5	16722.5
12190	12576.5	12576.5	16025	16818.5	16695.5	16080	16846.0	16723.0
12191	12577.0	12577.0	16026	16819.0	16696.0	16081	16846.5	16723.5
12192	12577.5	12577.5	16027	16819.5	16696.5	16082	16847.0	16724.0
12193	12578.0	12578.0	16028	16820.0	16697.0	16083	16847.5	16724.5
12194	12578.5	12578.5	16029	16820.5	16697.5	16084	16848.0	16725.0
			16030	16821.0	16698.0	16085	16848.5	16725.5
			16031	16821.5	16698.5	16086	16849.0	16726.0
			16032	16822.0	16699.0	16087	16849.5	16726.5
			16033	16822.5	16699.5	16088	16850.0	16727.0
			16034	16823.0	16700.0	16089	16850.5	16727.5
			16035	16823.5	16700.5	16090	16851.0	16728.0
			16036	16824.0	16701.0	16091	16851.5	16728.5
			16037	16824.5	16701.5	16092	16852.0	16729.0
			16038	16825.0	16702.0	16093	16852.5	16729.5
			16039	16825.5	16702.5	16094	16853.0	16730.0
			16040	16826.0	16703.0	16095	16853.5	16730.5
			16041	16826.5	16703.5	16096	16854.0	16731.0
			16042	16827.0	16704.0	16097	16854.5	16731.5
			16043	16827.5	16704.5	16098	16855.0	16732.0
			16044	16828.0	16705.0	16099	16855.5	16732.5
			16045	16828.5	16705.5	16100	16856.0	16733.0
			16046	16829.0	16706.0	16101	16856.5	16733.5
			16047	16829.5	16706.5	16102	16857.0	16739.0
			16048	16830.0	16707.0	16103	16857.5	16739.5
			16049	16830.5	16707.5	16104	16858.0	16740.0
			16050	16831.0	16708.0	16105	16858.5	16740.5
			16051	16831.5	16708.5	16106	16859.0	16741.0
			16052	16832.0	16709.0	16107	16859.5	16741.5
			16053	16832.5	16709.5	16108	16860.0	16742.0
			16054	16833.0	16710.0	16109	16860.5	16742.5
			16055	16833.5	16710.5	16110	16861.0	16743.0

# 16 MHz BAND ITU NBDP (Telex) FREQUENCY TABLE

The following frequencies are factory programmed.

16 MHz TELEX			16 MHz TELEX			16 MHz TELEX		
CH NO.	SHIP RX	SHIP TX	CH NO.	SHIP RX	SHIP TX	CH NO.	SHIP RX	SHIP TX
16111	16861.5	16743.5	16166	16889.0	16771.0	16221	16798.5	16798.5
16112	16862.0	16744.0	16167	16889.5	16771.5	16222	16799.0	16799.0
16113	16862.5	16744.5	16168	16890.0	16772.0	16223	16799.5	16799.5
16114	16863.0	16745.0	16169	16890.5	16772.5	16224	16800.0	16800.0
16115	16863.5	16745.5	16170	16891.0	16773.0	16225	16800.5	16800.5
16116	16864.0	16746.0	16171	16891.5	16773.5	16226	16801.0	16801.0
16117	16864.5	16746.5	16172	16892.0	16774.0	16227	16801.5	16801.5
16118	16865.0	16747.0	16173	16892.5	16774.5	16228	16802.0	16802.0
16119	16865.5	16747.5	16174	16893.0	16775.0	16229	16802.5	16802.5
16120	16866.0	16748.0	16175	16893.5	16775.5	16230	16803.0	16803.0
16121	16866.5	16748.5	16176	16894.0	16776.0	16231	16803.5	16803.5
16122	16867.0	16749.0	16177	16894.5	16776.5	16232	16804.0	16804.0
16123	16867.5	16749.5	16178	16895.0	16777.0	16233	16804.5	16804.5
16124	16868.0	16750.0	16179	16895.5	16777.5	16234	16805.0	16805.0
16125	16868.5	16750.5	16180	16896.0	16778.0	16235	16805.5	16805.5
16126	16869.0	16751.0	16181	16896.5	16778.5	16236	16806.0	16806.0
16127	16869.5	16751.5	16182	16897.0	16779.0			
16128	16870.0	16752.0	16183	16897.5	16779.5			
16129	16870.5	16752.5	16184	16898.0	16780.0			
16130	16871.0	16753.0	16185	16898.5	16780.5			
16131	16871.5	16753.5	16186	16899.0	16781.0			
16132	16872.0	16754.0	16187	16899.5	16781.5			
16133	16872.5	16754.5	16188	16900.0	16782.0			
16134	16873.0	16755.0	16189	16900.5	16782.5			
16135	16873.5	16755.5	16190	16901.0	16783.0			
16136	16874.0	16756.0	16191	16901.5	16783.5			
16137	16874.5	16756.5	16192	16902.0	16784.0			
16138	16875.0	16757.0	16193	16902.5	16784.5			
16139	16875.5	16757.5	16194	16785.0	16785.0			
16140	16876.0	16758.0	16195	16785.5	16785.5			
16141	16876.5	16758.5	16196	16786.0	16786.0			
16142	16877.0	16759.0	16197	16786.5	16786.5			
16143	16877.5	16759.5	16198	16787.0	16787.0			
16144	16878.0	16760.0	16199	16787.5	16787.5			
16145	16878.5	16760.5	16200	16788.0	16788.0			
16146	16879.0	16761.0	16201	16788.5	16788.5			
16147	16879.5	16761.5	16202	16789.0	16789.0			
16148	16880.0	16762.0	16203	16789.5	16789.5			
16149	16880.5	16762.5	16204	16790.0	16790.0			
16150	16881.0	16763.0	16205	16790.5	16790.5			
16151	16881.5	16763.5	16206	16791.0	16791.0			
16152	16882.0	16764.0	16207	16791.5	16791.5			
16153	16882.5	16764.5	16208	16792.0	16792.0			
16154	16883.0	16765.0	16209	16792.5	16792.5			
16155	16883.5	16765.5	16210	16793.0	16793.0			
16156	16884.0	16766.0	16211	16793.5	16793.5			
16157	16884.5	16766.5	16212	16794.0	16794.0			
16158	16885.0	16767.0	16213	16794.5	16794.5			
16159	16885.5	16767.5	16214	16795.0	16795.0			
16160	16886.0	16768.0	16215	16795.5	16795.5			
16161	16886.5	16768.5	16216	16796.0	16796.0			
16162	16887.0	16769.0	16217	16796.5	16796.5			
16163	16887.5	16769.5	16218	16797.0	16797.0			
16164	16888.0	16770.0	16219	16797.5	16797.5			
16165	16888.5	16770.5	16220	16798.0	16798.0			

## 18/19 MHz BAND ITU NBDP (Telex) FREQUENCY TABLE

The following frequencies are factory programmed.

18/19 MHz TELEX			18/19 MHz TELEX		
CH NO.	SHIP RX	SHIP TX	CH NO.	SHIP RX	SHIP TX
18001	19681.0	18870.5	18051	18895.5	18895.5
18002	19681.5	18871.0	18052	18896.0	18896.0
18003	19682.0	18871.5	18053	18896.5	18896.5
18004	19682.5	18872.0	18054	18897.0	18897.0
18005	19683.0	18872.5	18055	18897.5	18897.5
18006	19683.5	18873.0	18056	18898.0	18898.0
18007	19684.0	18873.5	18057	18898.5	18898.5
18008	19684.5	18874.0	18058	18899.0	18899.0
18009	19685.0	18874.5	18059	18899.5	18899.5
18010	19685.5	18875.0			
18011	19686.0	18875.5			
18012	19686.5	18876.0			
18013	19687.0	18876.5			
18014	19687.5	18877.0			
18015	19688.0	18877.5			
18016	19688.5	18878.0			
18017	19689.0	18878.5			
18018	19689.5	18879.0			
18019	19690.0	18879.5			
18020	19690.5	18880.0			
18021	19691.0	18880.5			
18022	19691.5	18881.0			
18023	19692.0	18881.5			
18024	19692.5	18882.0			
18025	19693.0	18882.5			
18026	19693.5	18883.0			
18027	19694.0	18883.5			
18028	19694.5	18884.0			
18029	19695.0	18884.5			
18030	19695.5	18885.0			
18031	19696.0	18885.5			
18032	19696.5	18886.0			
18033	19697.0	18886.5			
18034	19697.5	18887.0			
18035	19698.0	18887.5			
18036	19698.5	18888.0			
18037	19699.0	18888.5			
18038	19699.5	18889.0			
18039	19700.0	18889.5			
18040	19700.5	18890.0			
18041	19701.0	18890.5			
18042	19701.5	18891.0			
18043	19702.0	18891.5			
18044	19702.5	18892.0			
18045	19703.0	18892.5			
18046	18893.0	18893.0			
18047	18893.5	18893.5			
18048	18894.0	18894.0			
18049	18894.5	18894.5			
18050	18895.0	18895.0			

## 22 MHz BAND ITU NBDP (Telex) FREQUENCY TABLE

The following frequencies are factory programmed.

22 MHz TELEX			22 MHz TELEX			22 MHz TELEX		
CH NO.	SHIP RX	SHIP TX	CH NO.	SHIP RX	SHIP TX	CH NO.	SHIP RX	SHIP TX
22001	22376.5	22284.5	22051	22401.5	22309.5	22101	22426.5	22334.5
22002	22377.0	22285.0	22052	22402.0	22310.0	22102	22427.0	22335.0
22003	22377.5	22285.5	22053	22402.5	22310.5	22103	22427.5	22335.5
22004	22378.0	22286.0	22054	22403.0	22311.0	22104	22428.0	22336.0
22005	22378.5	22286.5	22055	22403.5	22311.5	22105	22428.5	22336.5
22006	22379.0	22287.0	22056	22404.0	22312.0	22106	22429.0	22337.0
22007	22379.5	22287.5	22057	22404.5	22312.5	22107	22429.5	22337.5
22008	22380.0	22288.0	22058	22405.0	22313.0	22108	22430.0	22338.0
22009	22380.5	22288.5	22059	22405.5	22313.5	22109	22430.5	22338.5
22010	22381.0	22289.0	22060	22406.0	22314.0	22110	22431.0	22339.0
22011	22381.5	22289.5	22061	22406.5	22314.5	22111	22431.5	22339.5
22012	22382.0	22290.0	22062	22407.0	22315.0	22112	22432.0	22340.0
22013	22382.5	22290.5	22063	22407.5	22315.5	22113	22432.5	22340.5
22014	22383.0	22291.0	22064	22408.0	22316.0	22114	22433.0	22341.0
22015	22383.5	22291.5	22065	22408.5	22316.5	22115	22433.5	22341.5
22016	22384.0	22292.0	22066	22409.0	22317.0	22116	22434.0	22342.0
22017	22384.5	22292.5	22067	22409.5	22317.5	22117	22434.5	22342.5
22018	22385.0	22293.0	22068	22410.0	22318.0	22118	22435.0	22343.0
22019	22385.5	22293.5	22069	22410.5	22318.5	22119	22435.5	22343.5
22020	22386.0	22294.0	22070	22411.0	22319.0	22120	22436.0	22344.0
22021	22386.5	22294.5	22071	22411.5	22319.5	22121	22436.5	22344.5
22022	22387.0	22295.0	22072	22412.0	22320.0	22122	22437.0	22345.0
22023	22387.5	22295.5	22073	22412.5	22320.5	22123	22437.5	22345.5
22024	22388.0	22296.0	22074	22413.0	22321.0	22124	22438.0	22346.0
22025	22388.5	22296.5	22075	22413.5	22321.5	22125	22438.5	22346.5
22026	22389.0	22297.0	22076	22414.0	22322.0	22126	22439.0	22347.0
22027	22389.5	22297.5	22077	22414.5	22322.5	22127	22439.5	22347.5
22028	22390.0	22298.0	22078	22415.0	22323.0	22128	22440.0	22348.0
22029	22390.5	22298.5	22079	22415.5	22323.5	22129	22440.5	22348.5
22030	22391.0	22299.0	22080	22416.0	22324.0	22130	22441.0	22349.0
22031	22391.5	22299.5	22081	22416.5	22324.5	22131	22441.5	22349.5
22032	22392.0	22300.0	22082	22417.0	22325.0	22132	22442.0	22350.0
22033	22392.5	22300.5	22083	22417.5	22325.5	22133	22442.5	22350.5
22034	22393.0	22301.0	22084	22418.0	22326.0	22134	22443.0	22351.0
22035	22393.5	22301.5	22085	22418.5	22326.5	22135	22443.5	22351.5
22036	22394.0	22302.0	22086	22419.0	22327.0	22136	22352.0	22352.0
22037	22394.5	22302.5	22087	22419.5	22327.5	22137	22352.5	22352.5
22038	22395.0	22303.0	22088	22420.0	22328.0	22138	22353.0	22353.0
22039	22395.5	22303.5	22089	22420.5	22328.5	22139	22353.5	22353.5
22040	22396.0	22304.0	22090	22421.0	22329.0	22140	22354.0	22354.0
22041	22396.5	22304.5	22091	22421.5	22329.5	22141	22354.5	22354.5
22042	22397.0	22305.0	22092	22422.0	22330.0	22142	22355.0	22355.0
22043	22397.5	22305.5	22093	22422.5	22330.5	22143	22355.5	22355.5
22044	22398.0	22306.0	22094	22423.0	22331.0	22144	22356.0	22356.0
22045	22398.5	22306.5	22095	22423.5	22331.5	22145	22356.5	22356.5
22046	22399.0	22307.0	22096	22424.0	22332.0	22146	22357.0	22357.0
22047	22399.5	22307.5	22097	22424.5	22332.5	22147	22357.5	22357.5
22048	22400.0	22308.0	22098	22425.0	22333.0	22148	22358.0	22358.0
22049	22400.5	22308.5	22099	22425.5	22333.5	22149	22358.5	22358.5
22050	22401.0	22309.0	22100	22426.0	22334.0	22150	22359.0	22359.0

## 22, 25/26 MHz BAND ITU NBDP (Telex) FREQUENCY TABLE

The following frequencies are factory programmed.

22 MHz TELEX			25/26 MHz TELEX			25/26 MHz TELEX		
CH NO.	SHIP RX	SHIP TX	CH NO.	SHIP RX	SHIP TX	CH NO.	SHIP RX	SHIP TX
22151	22359.5	22359.5	25001	26101.0	25173.0	25051	25198.0	25198.0
22152	22360.0	22360.0	25002	26101.5	25173.5	25052	25198.5	25198.5
22153	22360.5	22360.5	25003	26102.0	25174.0	25053	25199.0	25199.0
22154	22361.0	22361.0	25004	26102.5	25174.5	25054	25199.5	25199.5
22155	22361.5	22361.5	25005	26103.0	25175.0	25055	25200.0	25200.0
22156	22362.0	22362.0	25006	26103.5	25175.5	25056	25200.5	25200.5
22157	22362.5	22362.5	25007	26104.0	25176.0	25057	25201.0	25201.0
22158	22363.0	22363.0	25008	26104.5	25176.5	25058	25201.5	25201.5
22159	22363.5	22363.5	25009	26105.0	25177.0	25059	25202.0	25202.0
22160	22364.0	22364.0	25010	26105.5	25177.5	25060	25202.5	25202.5
22161	22364.5	22364.5	25011	26106.0	25178.0	25061	25203.0	25203.0
22162	22365.0	22365.0	25012	26106.5	25178.5	25062	25203.5	25203.5
22163	22365.5	22365.5	25013	26107.0	25179.0	25063	25204.0	25204.0
22164	22366.0	22366.0	25014	26107.5	25179.5	25064	25204.5	25204.5
22165	22366.5	22366.5	25015	26108.0	25180.0	25065	25205.0	25205.0
22166	22367.0	22367.0	25016	26108.5	25180.5	25066	25205.5	25205.5
22167	22367.5	22367.5	25017	26109.0	25181.0	25067	25206.0	25206.0
22168	22368.0	22368.0	25018	26109.5	25181.5	25068	25206.5	25206.5
22169	22368.5	22368.5	25019	26110.0	25182.0	25069	25207.0	25207.0
22170	22369.0	22369.0	25020	26110.5	25182.5	25070	25207.5	25207.5
22171	22369.5	22369.5	25021	26111.0	25183.0	25071	25208.0	25208.0
22172	22370.0	22370.0	25022	26111.5	25183.5	25072	26121.0	25208.5
22173	22370.5	22370.5	25023	26112.0	25184.0	25073	26121.5	25209.0
22174	22371.0	22371.0	25024	26112.5	25184.5	25074	26122.0	25209.5
22175	22371.5	22371.5	25025	26113.0	25185.0			
22176	22372.0	22372.0	25026	26113.5	25185.5			
22177	22372.5	22372.5	25027	26114.0	25186.0			
22178	22373.0	22373.0	25028	26114.5	25186.5			
22179	22373.5	22373.5	25029	26115.0	25187.0			
22180	22374.0	22374.0	25030	26115.5	25187.5			
22181	22374.5	22374.5	25031	26116.0	25188.0			
22182	22375.0	22375.0	25032	26116.5	25188.5			
22183	22375.5	22375.5	25033	26117.0	25189.0			
			25034	26117.5	25189.5			
			25035	26118.0	25190.0			
			25036	26118.5	25190.5			
			25037	26119.0	25191.0			
			25038	26119.5	25191.5			
			25039	26120.0	25192.0			
			25040	26120.5	25192.5			
			25041	25193.0	25193.0			
			25042	25193.5	25193.5			
			25043	25194.0	25194.0			
			25044	25194.5	25194.5			
			25045	25195.0	25195.0			
			25046	25195.5	25195.5			
			25047	25196.0	25196.0			
			25048	25196.5	25196.5			
			25049	25197.0	25197.0			
			25050	25197.5	25197.5			

# INDEX

2182 key 1-11

## A

AGC 1-5

AM broadcasting stations 1-14

Antenna tuning 1-10

## B

Backlighting 1-4

## C

CLARI/3 key 1-13

Clarifier 1-13

Class of emission 1-4

Control description 1-2

## D

Diagnostic test 4-2

Distress call 1-11

Dummy antenna 4-1

## E

Error indication 5-3

## F

Frequency selection

    custom channels 1-7

    direct frequency entry 1-6

    ITU telephony channels 1-8

    ITU Telex channels 1-9

Fuse replacement 5-3

## I

Indications 1-3

Intercom 2-2

## K

Keyboard test 4-3

## L

LCD test 4-3

Loudspeaker on/off 1-4

## M

Maintenance 4-4

Microphone usage 1-11

MIF commands 1-18

## N

NBDP Terminal 2-1

## P

Power on/off 1-4

## R

Receiving 1-13

Remote Station 2-2

RF GAIN 1-13

RF gain 1-13

ROM version no. 4-3

## S

S-meter 1-13

Scanning 1-15

Specifications iv

SQL/5 key 1-4

Squelch 1-4

Station name 1-10

Sweep 1-17

System configuration 1-1

System settings 3-1

## T

Transmitter output 1-11

Transmitter test 4-1

Transmitting 1-10

Troubleshooting 5-1

## U

User channels 3-3

## V

VOLUME control 1-4

## W

Weekly checks 4-1