

FURUNO

OPERATOR'S MANUAL

REMOTE STATION
FOR VHF RADIO

MODEL RB-700

(For ROM Version No.: 1.05)



FURUNO ELECTRIC CO., LTD.
NISHINOMIYA, JAPAN

©FURUNO ELECTRIC CO., LTD.

9-52, Ashihara-cho,
Nishinomiya, Japan 662

Telephone: 0798-65-2111
Telefax: 0798-65-4200(G111)

All rights reserved. Printed in Japan

(ETMI)

PUB. No. OME-50710
RB-700 (V1.05)

-Your Local Agent/Dealer

Initial : APR 1992
E : MAY 21, 1996





SAFETY INSTRUCTIONS

"DANGER", "WARNING" and "CAUTION" notices appear throughout this manual. It is the responsibility of the operator of the equipment to read, understand and follow these notices. If you have any questions regarding these safety instructions, please contact a FURUNO agent or dealer.



DANGER

This notice indicates a potentially hazardous situation which, if not avoided, will result in death or serious injury.



WARNING

This notice indicates a potentially hazardous situation which, if not avoided, could result in death or serious injury.



CAUTION

This notice indicates a potentially hazardous situation which, if not avoided, could result in minor or moderate injury, or property damage.



SAFETY INFORMATION FOR THE OPERATOR

WARNING



Do not open the cover of the equipment.

This equipment uses high voltage electricity which can shock, burn, or cause death. Only qualified personnel should work inside the equipment.

Do not disassemble or modify the equipment.

Fire, electrical shock or serious injury can result.

Immediately turn off the power at the ship's mains switchboard if water or foreign object falls into the equipment or the equipment is emitting smoke or fire.

Continued use of the equipment can cause fire, electrical shock or serious injury.

CAUTION

Do not place liquid-filled containers on the top of the equipment.

Fire or electrical shock can result if a liquid spills into the equipment.

Do not place heater near the equipment.

Heat can melt the power cord, which can result in fire or electrical shock.

Do not operate the unit with wet hands.

Electrical shock can result.

Use the correct fuse.

Use of the wrong fuse can cause fire or equipment damage.

Distress Calling Procedure

Photocopy this procedure, fill it in, and post it near remote station.

Whenever the radio is turned on, keep watch on channel 16 for distress or calling messages. Distress communications have absolute priority. If you hear Mayday, immediately stop any communication. Note the details of the message in the radio log. Be prepared to offer assistance or relay the distress message.

To make a Mayday call;

1. Press the CH16 key.
2. Pick up the handset, press the PTT switch and speaking **Slowly – Clearly – Calmly;**

- Say: “Mayday – Mayday – Mayday”.
- Say: “This is _____ , _____ , _____ ,
your boat’s name your boat’s name your boat’s name
_____”
your call sign

- Say: “Mayday _____”
your boat’s name
- Tell where you are. (What navigational aids or landmarks are near?)
- State the nature of your distress.
- Give number of adults and children aboard, and conditions of any injured.
- Estimate present seaworthiness of your boat.
- Briefly describe your boat:

_____ ; _____ FEET; _____ FEET;
State Registration No. Length Draft

_____ HULL; _____ TRIM; _____ MASTS; _____ POWER
Type Color Color Number HP

Construction Material

Anything else you think will help rescuers to find you.

- Say: “I will be listening on channel 16”.
3. End message by saying: “This is _____ OVER”
your boat’s name and call sign
 4. Release PTT switch and listen: coast station operator should answer. Listen to his (her) instructions. IF NO ONE ANSWERS, REPEAT CALL.

Table of Contents

Specifications.....	vi
---------------------	----

Operational Overview

General	1-1
Function	1-1
Connection	1-1
Power	1-1
Description of Controls	1-2
Keyboard	1-3
LCD Indications	1-5
Operating Conventions	1-6
Status at start up	1-6
Key operation	1-6
Channel display	1-6
The HOOK Key	1-7
Priority	1-8
What is priority?	1-8
Selecting priority	1-8
Assigning priority	1-8
Priority for multiple remote stations	1-8
Priority order	1-8

Operation

Basic Operations	2-1
Turning the power on and off and adjusting speaker volume	2-1
Turning the speaker on and off	2-1
Adjusting illumination	2-1
Selecting rf output power	2-1
Selecting Channel Mode	2-2
Selecting Channel	2-3
Dual Watch	2-4
Scanning	2-6
Scanning mode	2-6
Intercom Communication	2-7

Maintenance and Troubleshooting	Routine Maintenance	3-1
	Troubleshooting for the User	3-2
	Location of breaker	3-3
	Troubleshooting for qualified personnel (self test)	3-4
	Basic procedure	3-4
	Keyboard test	3-5
	SCI test	3-6
	Control line test	3-7
	Displays of program no. & Remote station no.	3-9
 Channel List		
	Marine VHF Channel Frequencies	A-1

Specifications

The RB-700 provides for remote control of a FURUNO VHF radiotelephone equipped with FURUNO MIF radio interface.

VHF Radiotelephone Connection	FM-7000, FM-7500
Control	Channel Rf output power Scanning Intercom
Display	LCD
Audio Output	Internal speaker: 1 W min. (8 ohms) External speaker: 1 W min. (8 ohms) Handset speaker: 1 mW min. (200 ohms), max. better than 10 mW
Line I/O	0 dBm, 600 ohms
Handset Input	-46 dBm (600 ohms)
Communications Interface	MIF (FURUNO radio interface) current loop
MIF Cable Length	50 m max. (100 m with Distributor DB-500)
Dimensions and Weight	190 (W) × 75 (H) × 220 (D) mm, 2.5 kg
Environmental Conditions	Temperature: -20°C to +55°C Relative humidity: 93% at +40°C Splashproof construction: Meets JIS (Japan Industrial Standard) C 0920
Power Supply and Power Consumption	12 VDC +30%, -10% (floating), less than 1A, supplied from VHF radiotelephone or Distributor DB-500.
Color	Panel: Munsell N3.0 Chassis: Munsell 2.5 GY 5/1.5

Operational Overview

This chapter provides an introduction to the RB-700.

General

Function

The RB-700 provides for remote control of a FURUNO VHF radiotelephone equipped with MIF radio interface (FM-7000, FM-7500), in full compliance with all SOLAS Convention carriage requirements of the GMDSS. Splashproof and compact construction permits installation almost anywhere.

Its compact size is especially attractive for small GMDSS vessels: SOLAS Convention requires vessels to keep a continuous watch on VHF channel 16 from a navigational position. Thus, the RB-700 is the perfect choice for the small wheelhouse or bridge which may not afford the space for a VHF radiotelephone.

Connection

The RB-700 connects directly to the VHF radiotelephone for single remote station installation, or through the Distributor DB-500 for multiple remote station installation (maximum 4).

Power

The RB-700 is powered by the VHF radiotelephone or the Distributor.

Description of Controls

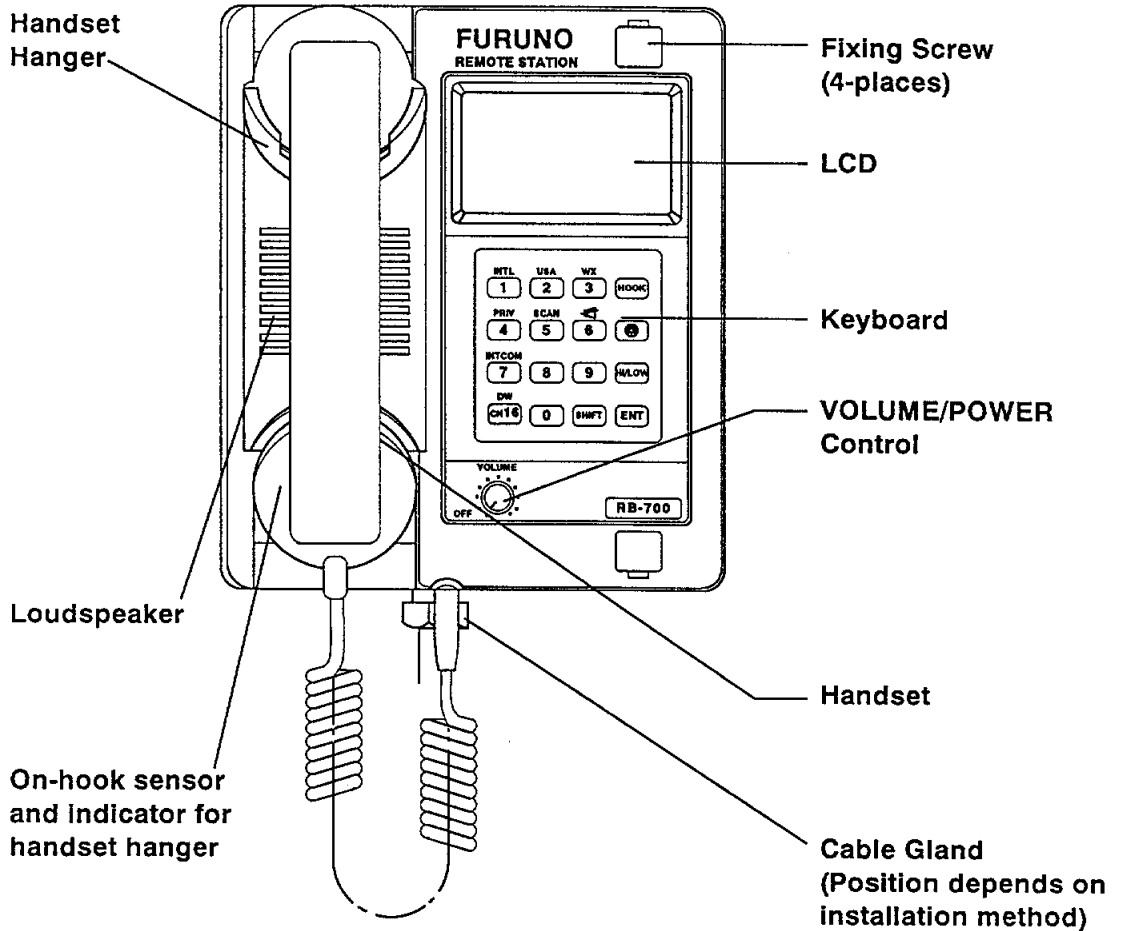

Figure 1-1 RB-700

Keyboard

The keyboard consists of 16 keys. The **SHIFT** key selects the secondary function of keys so equipped; that is, keys 1–7 and **CH16**. To enable the secondary functions, press **SHIFT** followed by desired secondary function. The asterisk (*) appears on the display when the secondary functions are active.

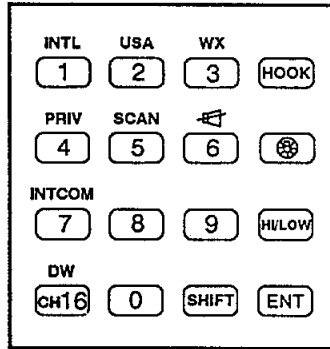



















Figure 1-2 Keyboard

Table 1-1 Description of controls

Key	Secondary Function
	Primary Function
INTL 	Selects international mode. ----- Enters 1.
USA 	Selects USA mode. ----- Enters 2.
WX 	Selects weather mode. ----- Enters 3.
PRIV 	Selects private mode. ----- Enters 4.
SCAN 	Starts scanning. ----- Enters 5.
 	Turns the speaker on or off. ----- Enters 6.
INTCOM 	Activates intercom (interphone). ----- Enters 7.
	Enters 8.
	Enters 9.
	Enters 0.
DW 	Starts Dual Watching. ----- Selects channel 16.
	This function changes depending on the installation method. Refet to page 1-7.
	Adjusts backlighting for LCD and keyboard.
	Selects output power; HI: 25W, LOW: 1W
	Selects secondary function mode.
	Terminates keyboard.

LCD Indications

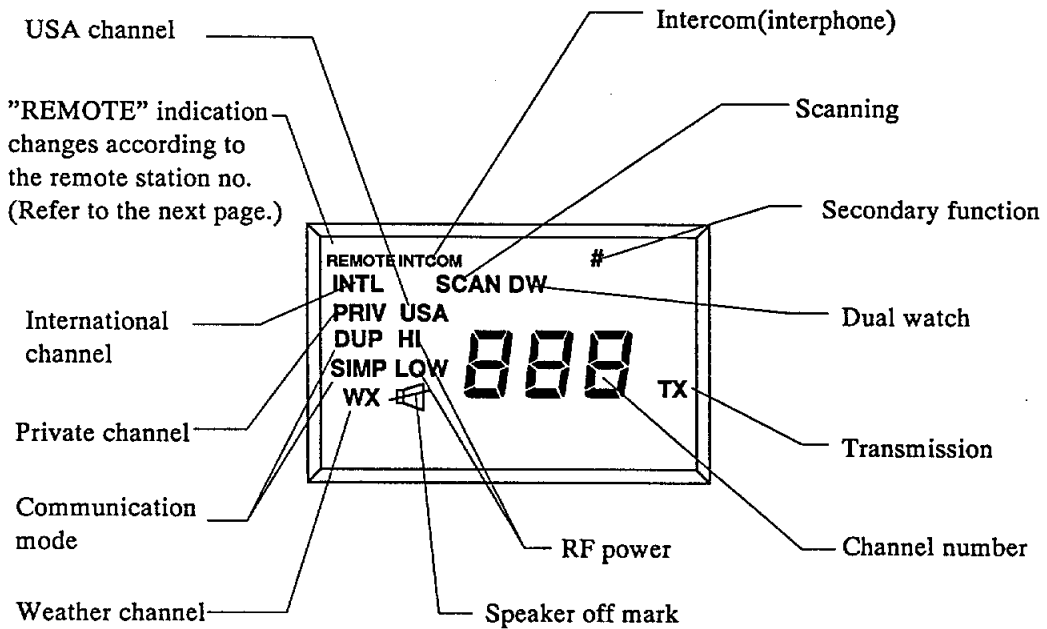

Figure 1-3 LCD indications

Operating Conventions

Overview

Depending on the remote station number (1 to 4) decided at installation, one of the displays shown below appears when turning on the power. The remote station number can be confirmed by turning on the power while pressing and holding down the ENT key. See page 3-9.

Status at Start up

- Remote station No.: "1" → You can hear receiver noise.

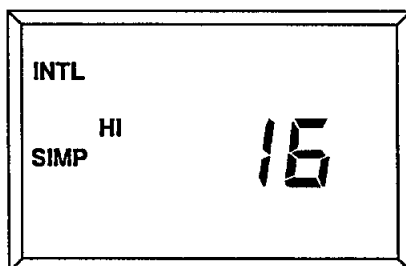

→ When CH16 is selected by VHF radiotelephone.

- Remote station No.: "2", "3" or "4"

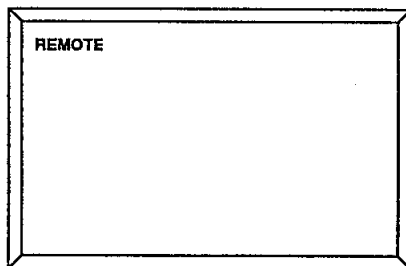

To start remote operation, release the handset from hanger.

Key operation

- Valid key input releases a beep.
- Invalid key input releases a series of beeps and the unit reverts to the previous display.
- When entering a line of data, press each key within five seconds of one another. Otherwise, the RB-700 will return control to the previous display.
- To enable the secondary functions, press the SHIFT key (# appears) followed by desired secondary function.
- Intercom calling: Beep is released.

The HOOK Key

The function of the HOOK key changes according to the remote station number given at installation.

- Remote Station No.: "1"

If you want to keep watch on channel being used (e.g. CH10) with the handset hung, press the HOOK key and then place the handset in the hanger.

(ex.) CH10 is in use.

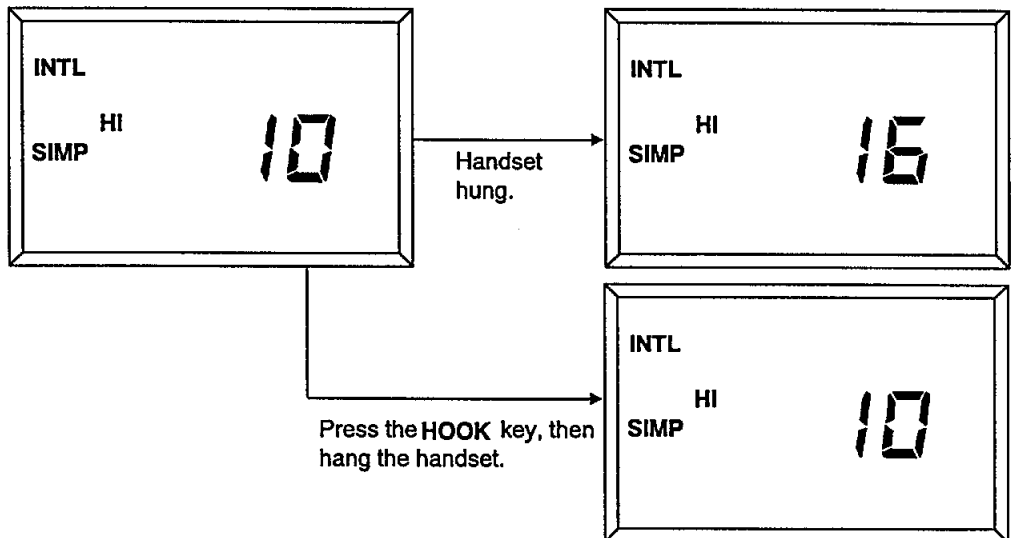

- Remote Station No.: "2", "3" or "4"

The channel data can be displayed with the handset hung.

(ex.) CH16 is selected by VHF radiotelephone.

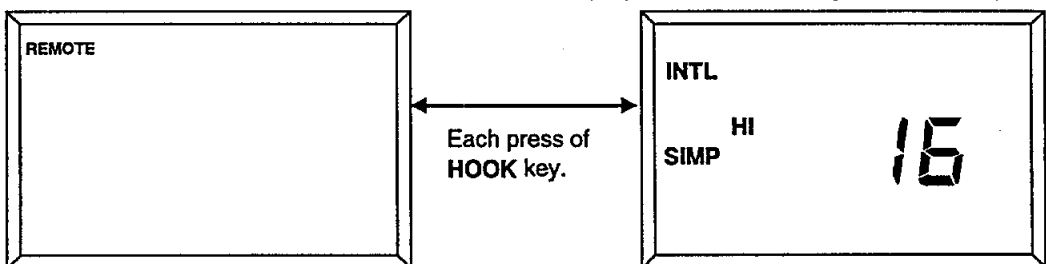

Priority

What is priority?

The VHF radiotelephone may have several types of radio equipment connected to it, in addition to one or more remote stations. Priority determines which unit's commands takes precedence over other units.

When the remote station has priority, the VHF radiotelephone stops operating and awaits the command of the remote station when the remote station handset is picked up.

The distress alert transmitted by the Digital Selective Calling (DSC) unit takes absolute priority.

Selecting priority

The remote station has priority in the factory setting. If necessary, priority can be given to the VHF radiotelephone by changing an internal setting. This should be done by a qualified technician.

Assigning priority

GMDSS vessels

SOLAS regulations require that vessels keep a continuous watch on channel 16 from a navigational position. Therefore, assign priority to the unit (VHF or RB-700) which is installed where the vessel is normally navigated.

non-GMDSS vessels

Priority is usually given to the unit used most often.

Priority for multiple remote stations

Up to four remote stations can be installed by using the DB-500 Distributor. The terminal board on the DB-500 contains five terminals, numbered 1–5. Terminal #1 is for connection of VHF radiotelephone, terminals #2–#5 for connection of remote stations. Remote station priority is assigned by terminal number; 2 for highest, 5 for lowest.

Priority order

Table 1-2 Priority order

Priority	RB-700 Priority	VHF Priority
1	Distress Alert Transmission by DSC	
2	RB-700	DSC
3	DSC	VHF (*)
4	VHF	RB-700

(*): If the "REMOTE" display on the VHF blinks, the RB-700 operation is disable even if the handset of the VHF is on the hanger. (ON HOOK)

This chapter covers basic operation, from turning the power on and off to scanning.

Basic Operations

Turning the power on and off and adjusting speaker volume

The **VOLUME** control turns on and off the power and adjusts the volume of the speaker. To turn on the power, turn the control clockwise until you hear a click. Further clockwise rotation adjusts the volume of the speaker. To turn off the power, turn the control counterclockwise until you hear the click, **after hanging the handset**. Otherwise, the keys on the VHF radiotelephone lock.

Turning the speaker on and off

The **6** key turns the speaker on and off. Press the **SHIFT** key followed by the **6** key to turn the speaker on or off. When the speaker is on you can hear receiver noise when the handset is released from the hanger or the **HOOK** key is pressed (if remote station no. is 2,3 or 4). When the speaker is off, the “speaker off mark” appears on the display.

Adjusting illumination

The **DIMMER** key adjust the backlighting of the LCD and keyboard, in levels of bright, medium, dim and off.

Selecting RF output power

Each press of the **HI/LOW** key selects high (25 W) or low (1 W) output power. The output power is automatically set for low on the following channels: International channels CH15 and CH17, and USA channels CH13, CH17 and CH67.

Note that the output power can be changed from 1 W to 25 W on USA channel CH13 or CH67 by pressing and holding down the **HI/LOW** key at transmission.

Selecting Channel Mode

You can select international, USA, weather and private channels (where permitted). Press **SHIFT** followed by desired channel key.

- **NOTE 1:** *When pressing PRIV (or WX) key, the previously selected private (or weather) channel appears.*
- **NOTE 2:** *The use of private channels requires special permission. For further information consult a FURUNO authorized agent or dealer.*

Table 2-1 Channel modes

Channel Type	Key Input	LCD
INT Channel	SHIFT → ^{INTL} 1	INTL
USA Channel	SHIFT → ^{USA} 2	USA
Weather Channel	SHIFT → ^{WX} 3	WX
Private Channel	SHIFT → ^{PRIV} 4	PRIV

Selecting Channel

Enter channels through the keyboard. Entry of an invalid channel causes the RB-700 to reject the channel and revert to the previous channel.

To select channel 20, for example;

1. Press 2 followed by 0. "20" blinks on the display.

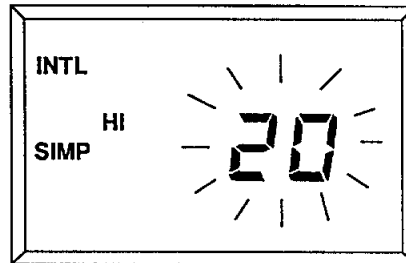

Figure 2-1

2. Press ENT.

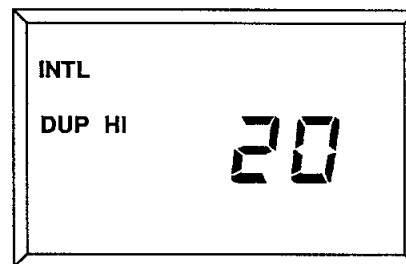

Figure 2-2

- **NOTE:** To display private channels L, F and P, press SHIFT followed by several presses of PRIV.

Dual Watch

The Dual Watch function allows you to keep watch on channel 16 and another channel of your choice. The VHF radiotelephone watches on CH16 and the channel selected (CH20, for example) by the following times:

Channel indication	CH20 → CH16 → CH20 → CH16 → CH20 → ...					
Receiving time (sec.)	1	0.15	1	0.15	1

Figure 2-3

procedure

1. Select the channel you want to watch along with CH16; for example, CH20.

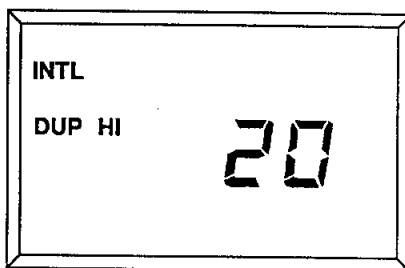

Figure 2-4

2. Press **SHIFT** followed by **CH16**. The indication “DW” appears on the display and dual watch starts. Note that LCD does not show “CH16” in spite of watch on CH16.

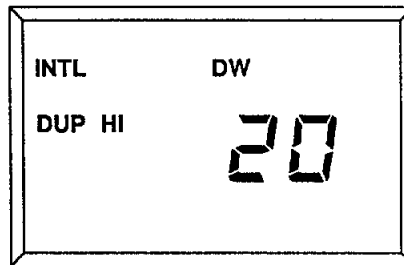

Figure 2-5

3. To escape, hit any key or press the PTT switch on the handset.

■ **NOTE 1:** *When a signal is present on CH16;*

- *the receiver locks on CH16 and ignores other dual watch channel, and*
- *five seconds after the signal on CH16 is gone, the VHF radiotelephone reverts to dual watching again.*

■ **NOTE 2:** *When a signal is present on the channel being watched, keep dual watching until the signal is gone.*

Scanning

The receiver scans a channel mode (USA, etc.) in ascending channel order, stopping when a signal above a preset level is received. The receiver resumes scanning after the preset scan lock time has elapsed.

Scanning mode

The FM-7000 and FM-7500 perform multiple watch scanning. This type of scanning watches all channels in a channel mode, watching CH16 between channels.

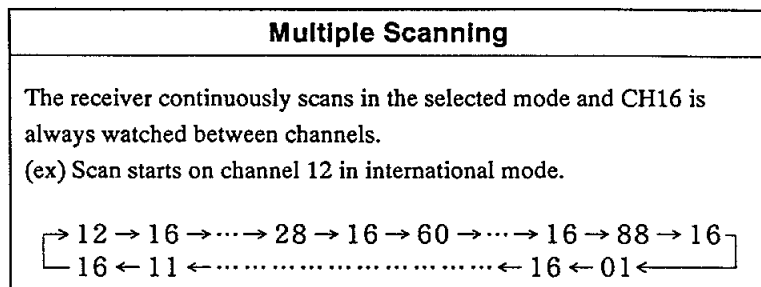

Figure 2-6 How multiple scanning works

■ **NOTE:** The FM-7000 and FM-7500 can also be set to scan a channel mode for one cycle, by adjustment of internal setting. Consult your dealer for further details.

The RB-700 can only start and stop scanning; scan stop mode (LOCK or HOLD mode) is set on the VHF radiotelephone.

procedure

1. Select channel mode. Press **SHIFT** followed by **5** to start scanning.

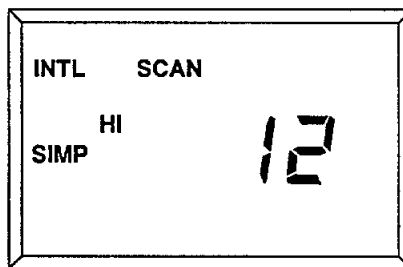

Figure 2-7

2. To escape, hit any key or press the PTT switch.

The operation executed, when a signal is present on a channel, depends on the setting of scan stop mode (LOCK or HOLD mode). Refer to each Operator's Manual of the FM-7000 and FM-7500.

Intercom Communication

The intercom function provides voice communications between the remote station and VHF radiotelephone.

procedure

1. Pick up the handset.
2. Press **SHIFT** followed by **7**. (The dash on the display blinks.)

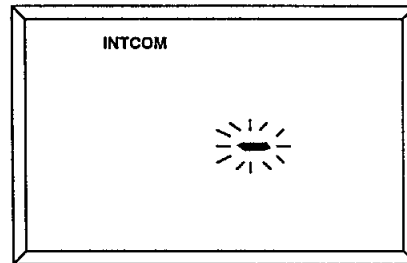

Figure 2-8

3. Enter intercom no. (1 for VHF radiotelephone) and press **ENT**.

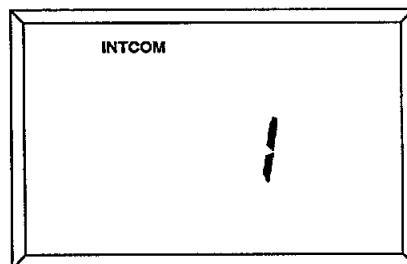

Figure 2-9

4. Press the **PTT** switch on the handset and speak into the handset to communicate.
5. After completing communications, place the handset in the hanger.

This page intentionally left blank.

Maintenance and Troubleshooting

This chapter provides the procedures necessary for the maintenance and troubleshooting of this unit.

Routine Maintenance

Regular maintenance is essential for good performance. A regular maintenance program should be established and should include the checks described in Table 3-1.

Table 3-1 Routine maintenance

Item	Check
Main Unit	<p>The external surfaces of the RB-700 may be cleaned when necessary. The only cleaning agent recommended for these surfaces is a mild detergent in water. Apply the solution sparingly with a stiff, non-metallic brush to work all loose dirt away from the remote station. A soft, absorbent lintless cloth or tissue should then be used to dry the unit. Be sure no water remains entrapped in crevices or connectors.</p> <p>If the unit is exposed to water splash, a service technician should check it for watertightness at least every two years.</p>
Power	<p>The RB-700 is powered by 12 VDC +30%, -10% (10.8 V – 15.6 V) from the VHF radiotelephone or distributor.</p> <p>Regularly check the power source voltage to be sure it is within that rating.</p>
Handset Sensor	<p>A sensor in the RB-700 detects whether the handset is hung or not, by bouncing light waves off the reflecting seal attached near the center of the transmitter microphone. If the sensor is dirty or the seal is damaged, the sensor cannot perform its intended function. Clean the sensor and replace the seal (supplied) when necessary.</p>
Handset	<p>Check the transmitter microphone and receiver for foreign material.</p>

Troubleshooting for the User

This section provides troubleshooting checks which the user can do to restore normal operation.

Table 3-2 Troubleshooting table for the user

IF...	THEN...	REMEDY
the unit does not work at all	<ul style="list-style-type: none"> the radiotelephone (or distributor) may be off. the MIF cable may be loose. 	<ul style="list-style-type: none"> Turn on the radiotelephone (or distributor). Connect the cable.
the LCD is functioning normally but no sound	<ul style="list-style-type: none"> the speaker is off. the squelch on the VHF radiotelephone is on. 	<ul style="list-style-type: none"> Press SHIFT, 6.
signal is weak (cannot receive)	<ul style="list-style-type: none"> the antenna cable of the radiotelephone may be damaged or disconnected. an interfering object (vessel, crane, mountain, etc.) may be in the transmission path. 	<ul style="list-style-type: none"> Check the radiotelephone for proper operation. Line-of-sight is a principle of VHF communications.
“TX” appears but cannot transmit, or insufficient output power	<ul style="list-style-type: none"> the output power may be selected for LOW. certain channels must be transmitted on LOW power. 	<ul style="list-style-type: none"> Set the output power for HIGH. USA CH13, CH17, CH67 INTL CH15, CH17 should be transmitted on LOW power.
the PTT switch is pressed but “TX” does not appear	<ul style="list-style-type: none"> you selected an invalid channel. the handset may be damaged. 	<ul style="list-style-type: none"> Select a valid channel. Check the handset and the connector for damage.
you cannot start scan or dual watch	<ul style="list-style-type: none"> noise level may be too high because squelch setting on the radiotelephone is too low. 	<ul style="list-style-type: none"> Adjust the squelch so noise just fades away.

**Location of
breaker
(For qualified
personnel)**

A breaker inside the unit protects it against reverse polarity of the ship's mains and equipment fault. When the unit cannot be operated, check if the breaker is protruding. If it is, push it in to restore normal operation. If the breaker trips again, call for service.

procedure

Remove the two fixing screw covers on the front panel. Loosen the four fixing screws to open the unit. The breaker is on the MAIN board (bottom chassis).

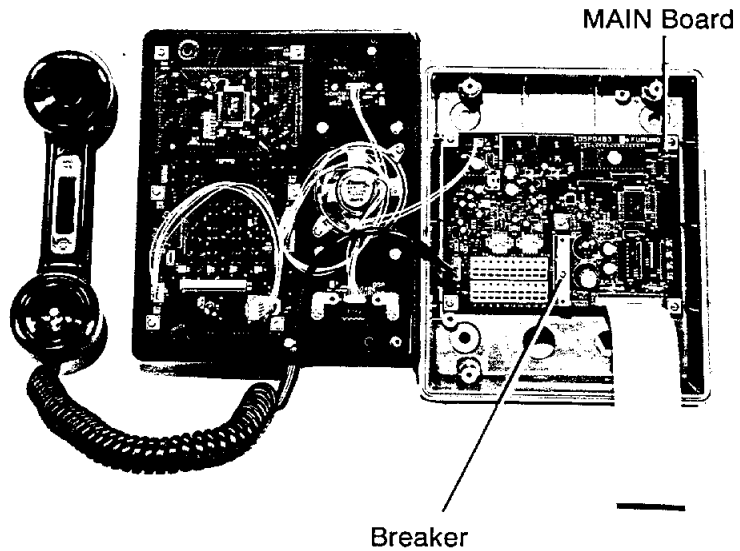

T Photo No.1204

Figure 3-1 RB-700, unit opened

Troubleshooting for qualified personnel (self test)

This section covers the unit's built-in self test facility, which is intended for use by qualified personnel.

Three types of checks are available: keyboard, SCI (Serial Communication Interface: remote line test) and CPU control line.

Basic procedure

1. While pressing and holding down **SHIFT**, turn on the power.

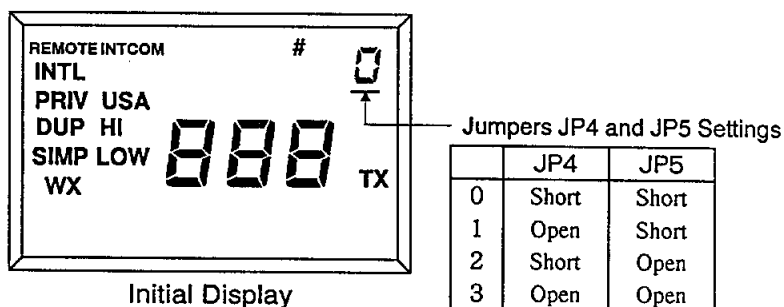

Figure 3-2

2. Select desired test:
 - press **HOOK** for the keyboard test,
 - press the **DIMMER** key for the SCI test, or
 - press **HI/LOW** for the CPU output test.

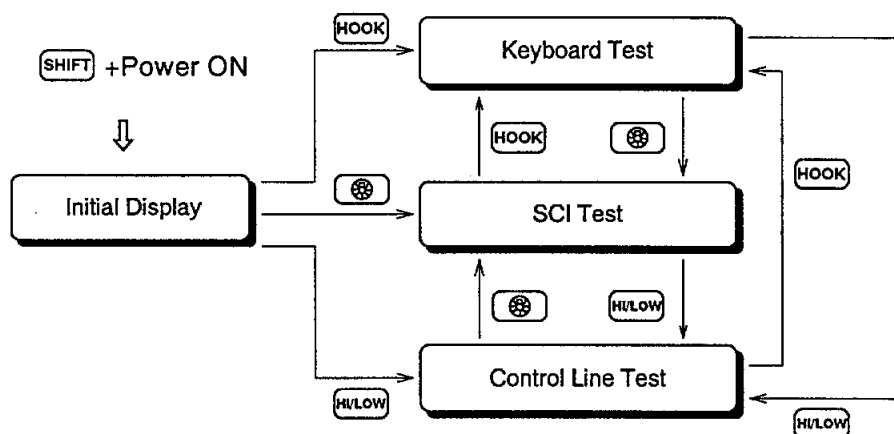

Figure 3-3

3. After the test is completed, select another test by pressing appropriate key, or turn off the power to exit the self test function.

Keyboard test

This test checks the keyboard and LCD for proper operation. Press each key one by one. The indication associated with the key pressed appears on the display if the key is functioning normally. For example, press the 1 key. The display should look like Figure 3-4.

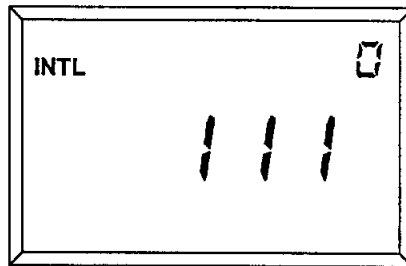

Figure 3-4

Table 3-3 shows key and associated LCD indication.

Table 3-3 Keyboard test and associated indication

Key	Indication	Key	Indication	Key	Indication	Key	Indication
INTL 1	INTL, 111	USA 2	USA, 222	WX 3	WX, 333	HOOK	(*1)
PRIV 4	PRIV, 444	SCAN 5	SCAN, 555	A 6	A, 666	⊕	(*2)
INTCOM 7	INTCOM, 777	8	HI, 888	9	DUP, 999	HI/LOW	(*3)
DW CH16	DW	0	SIMP, 000	SHIFT	LOW, #	ENT	—

- (*1): Continue keyboard test.
- (*2): To start SCI test.
- (*3): To start control line test.

other indications

- Pressing the PTT switch displays "TX."
- Releasing the handset from the hanger displays "REMOTE."

SCI test

preparation

Short terminals #1 (TXD-H) and #3 (RXD-H) and #2 (TXD-C) and #4 (RXD-C) on TB1 of the MAIN Board to loop back CPU output to the CPU.

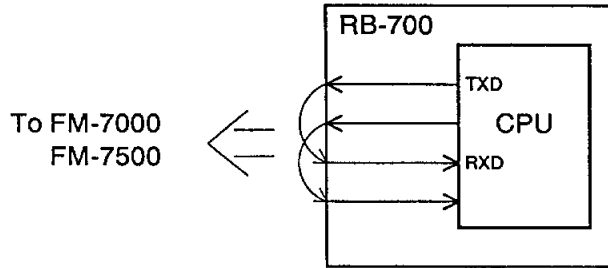

Figure 3-5

procedure

Press each key one by one. The unit releases a beep if the MIF command is output correctly. Table 3-4 shows key and associated MIF command.

Table 3-4 Key and associated MIF command

Key	MIF Command	Key	MIF Command	Key	MIF Command	Key	MIF Command
INTL 1	CHN	USA 2	CHU	WX 3	CHW	HOOK	(*1)
PRIV 4	CHP	SCAN 5	SCS	📢 6	CAID	📶	(*2)
INTCOM 7	CACH	SG 8	PO3	9	DUS	HI/LOW	(*3)
DW PH16	CHN016	0	DUR	SHIFT	PO1	ENT	————

Handset	MIF Command
PTT switch pressed	RE
Handset set to hanger	FZR
Handset picked up	FZS

(*1): To start keyboard test.
 (*2): Continue SCI test.
 (*3): To start control line test.

■ **NOTE:** MIF is the control signal for FURUNO radio equipment.

Control line test (CPU check)

This test checks the control lines of the CPU for proper operation, by enabling manual change of output level (H, L) on CPU ports P50 – P57. Table 3-5 shows key, port and initial state.

Table 3-5 Key, port and initial state

Key	Port Controlled	Function (port name)	Initial State	Function when initial state is changed
INTL 1	P51	HS MUTE	H	Handset on
USA 2	P52	SP MUTE	H	Speaker on
WX 3	P53	Not used	_____	_____
PRIV 4	P54	RX MUTE	L	RX mute
SCAN 5	P55	H.T.	L	Not used
6	P56	TX KEY	L	TX
INTCOM 7	P57	DIM	H	Dimmer off
8	_____	Set for H	_____	_____
9	_____	Set for L	_____	_____
0	P50	MIC OFF	H	MIC on

procedure

1. Enter port number desired (P50 – P57) with numeric keys 0 – 7. To select port 52, for example, press 2. The display shown in Figure 3-6 appears.

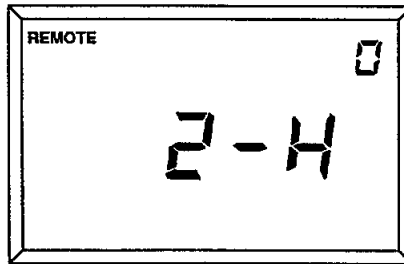
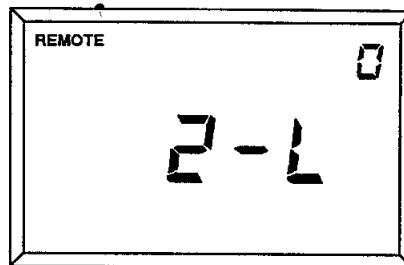

Figure 3-6

2. Set port output level; press 8 for high, or 9 for low.



The P52 output is set to L(low).

Figure 3-7

3. Press ENT. The screen returns to the beginning of the test. (Now the P52 output is set to low, so you should preset it to high for normal operation.)

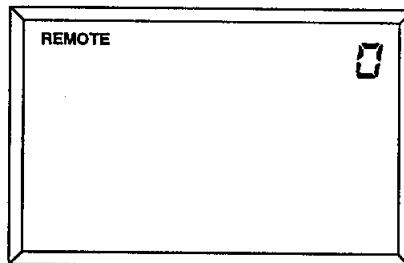

Displays of program no. & Remote station no.

- (1) While pressing and holding down ENT, turn on the power.
- (2) The program number and remote station number appear on the display.

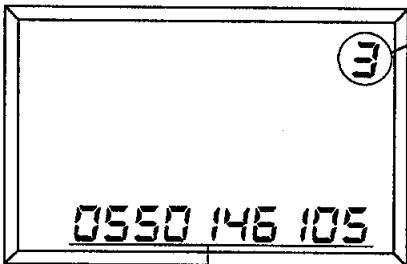

Remote Station Number
(depending on the settings
of JP1 and JP6)

No.	JP1	JP6
1	Short	Short
2	Open	Short
3	Short	Open
4	Open	Open

Program Number

- (3) Turn off the power and turn it on again for normal operation.

MARINE VHF CHANNEL FREQUENCIES

INTERNATIONAL CHANNELS

CH	TX	RX	CH	TX	RX
01	156.050	160.650	60	156.025	160.625
02	156.100	160.700	61	156.075	160.675
03	156.150	160.750	62	156.125	160.725
04	156.200	160.800	63	156.175	160.775
05	156.250	160.850	64	156.225	160.825
06	156.300	156.300	65	156.275	160.875
07	156.350	160.950	66	156.325	160.925
08	156.400	156.400	67	156.375	156.375
09	156.450	156.450	68	156.425	156.425
10	156.500	156.500	69	156.475	156.475
11	156.550	156.550	70	156.525	156.525
12	156.600	156.600	71	156.575	156.575
13	156.650	156.650	72	156.625	156.625
14	156.700	156.700	73	156.675	156.675
15	156.750	156.750	74	156.725	156.725
16	156.800	156.800	77	156.875	156.875
17	156.850	156.850	78	156.925	161.525
18	156.900	161.500	79	156.975	161.575
19	156.950	161.550	80	157.025	161.625
20	157.000	161.600	81	157.075	161.675
21	157.050	161.650	82	157.125	161.725
22	157.100	161.700	83	157.175	161.775
23	157.150	161.750	84	157.225	161.825
24	157.200	161.800	85	157.275	161.875
25	157.250	161.850	86	157.325	161.925
26	157.300	161.900	87	157.375	161.975
27	157.350	161.950	88	157.425	162.025
28	157.400	162.000			

(MHz)

USA CHANNELS

CH	TX	RX	CH	TX	RX
01A	156.050	156.050	60	156.025	160.625
02A	156.100	156.100	61	156.075	160.675
03A	156.150	156.150	62	156.125	160.725
04A	156.200	156.200	63A	156.175	156.175
05A	156.250	156.250	64	156.225	160.825
06	156.300	156.300	65A	156.275	156.275
07A	156.350	156.350	66A	156.325	156.325
08	156.400	156.400	67	156.375	156.375
09	156.450	156.450	68	156.425	156.425
10	156.500	156.500	69	156.475	156.475
11	156.550	156.550	70	156.525	156.525
12	156.600	156.600	71	156.575	156.575
13	156.650	156.650	72	156.625	156.625
14	156.700	156.700	73	156.675	156.675
15	—	156.750	74	156.725	156.725
16	156.800	156.800	77	156.875	156.875
17	156.850	156.850	78A	156.925	156.925
18A	156.900	156.900	79A	156.975	156.975
19A	156.950	156.950	80A	157.025	157.025
20	157.000	161.600	81A	157.075	157.075
21A	157.050	157.050	82A	157.125	157.125
22A	157.100	157.100	83A	157.175	157.175
23A	157.150	157.150	84	157.225	161.825
24	157.200	161.800	85	157.275	161.875
25	157.250	161.850	86	157.325	161.925
26	157.300	161.900	87	157.375	161.975
27	157.350	161.950	88A	157.425	157.425
28	157.400	162.000			

(MHz)

WEATHER CHANNELS

CH	RX
WX0	162.550
WX1	162.400
WX2	162.475
WX3	162.425
WX4	162.450
WX5	162.500
WX6	162.525
WX7	161.650
WX8	161.775
WX9	163.275

(MHz)

5-11-6

FURUNOREVISION RECORD OF OPERATOR'S/INSTALLATION MANUALMODEL: RB-700PUBLICATION NO.: OM-E 5071-0*

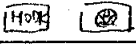
REV. NO.	DATE	REVISED PAGE	DETAILS	PERSON IN CHG.
A		—	First Edition	
B	92-7	TOC i	Deleted "Adjusting the squelch".	M. OSAKO
		SPEC iii	Deleted "Squelch on and off".	
		1-2, 1-3	Deleted "SQ" indication.	
		1-3	keys 1-8 → keys 1-7	
		1-4	Deleted "SQ", "Turns squelch on or off".	
		1-7 ²³ / ₂₆	Deleted "If you don't, ... by the remote station".	
		2-1	Deleted "Adjusting the squelch".	
		3-4	Revised Figure 3-3 	
		3-5 21	LCD and dimmer for → LCD for	
		24	press the 3 key. → press the 1 key.	
		4-4	Added "Refer to NOTE ..." in the table.	
		D-1	C5071-G01-D → E	
		D-2	C5071-G02-D → E	
		S-1	Added C5071-C01-A (Interconnection Diagram)	
		3-7	Revised Table 3-5	
		2-3	To select USA channel → To select channel..	
		A-1	minor	
C	1993-2	All pages		
	(Ver. 1.05)		Installation Instructions is separated from Operators Manual.	T. SAITO
D	June '94	i ii	} Minor	T. SAITO
E	1996.5	i ~ ii	PL法追加	≡ #3
		iii ~ vi	ハコ番号変更	
		3-4	Qualified personnel 追加	
		3-2	PL法	
		3-3	For qualified personnel 追加	

①

②

③

④

⑤

⑥

⑦

⑧